

2023/24

CATALOGUE



artelamp.ru



ARTE Lamp

Мы стараемся идти в ногу со временем и следить за современными тенденциями.

В этом году компании исполняется 30 лет.

Пришло время привнести глоток свежего воздуха, при этом отдавая дань традициям

ARTE LAMP является воплощением многообразия ассортимента и итальянского качества, тенденций и направлений.

Ребрендинг — шаг к единству богатой истории и новых веяний современности.

Строгие лаконичные линии, трендовые цвета, современные модели — это новая жизнь бренда **ARTE LAMP**.

New Look



Main

2024

collection

Иллюстрации в каталоге
созданы инструментами
нейросети **#Midjourney**

Midjourney — независимая
исследовательская лаборатория,
изучающая новые способы
мышления и расширяющая
творческие способности
человечества

10

Chapter List

INDEX |
СОДЕРЖАНИЕ

358

CREATIVITI |
оригинальные

408

SPOT
ILLUMINAZIONE |
СПОТЫ

38

COMFORT ZONE |
зональное освещение

422

BAGNO |
для ванной
комнаты

150

TRADIZIONE |
в классическом
стиле

204

CONTEMPO |
в современном
стиле

438

OUTDOOR |
уличные

280

LED LAMPADARI |
светодиодные
модели

478

INDEX |
СОДЕРЖАНИЕ

488

DETAILS |
ДОПОЛНЕНИЕ

ЛЮСТРЫ ПОДВЕСНЫЕ

CHANDELIERS



ЛЮСТРЫ ПОДВЕСНЫЕ

CHANDELIERS

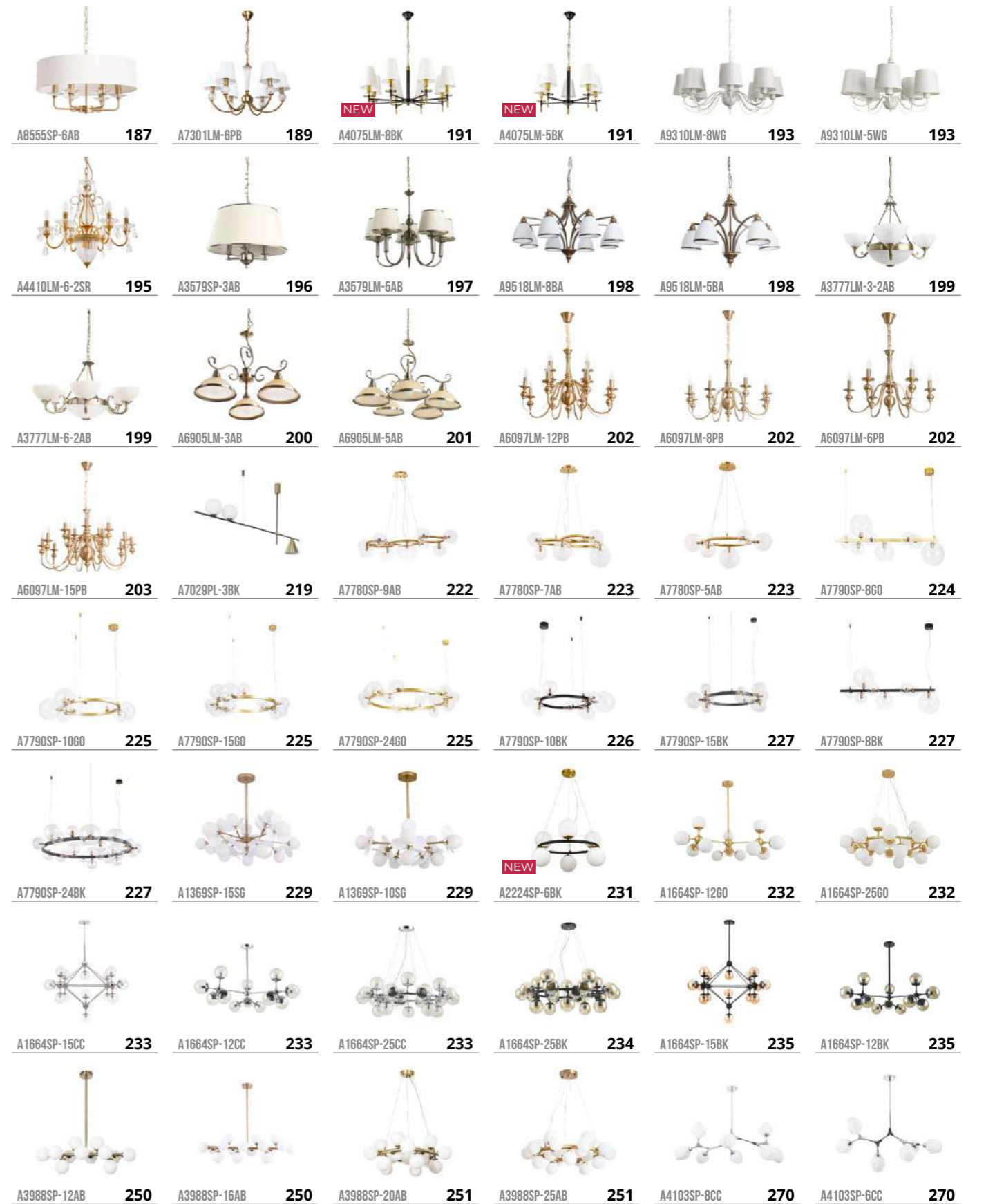

ЛЮСТРЫ ПОДВЕСНЫЕ

CHANDELIERS

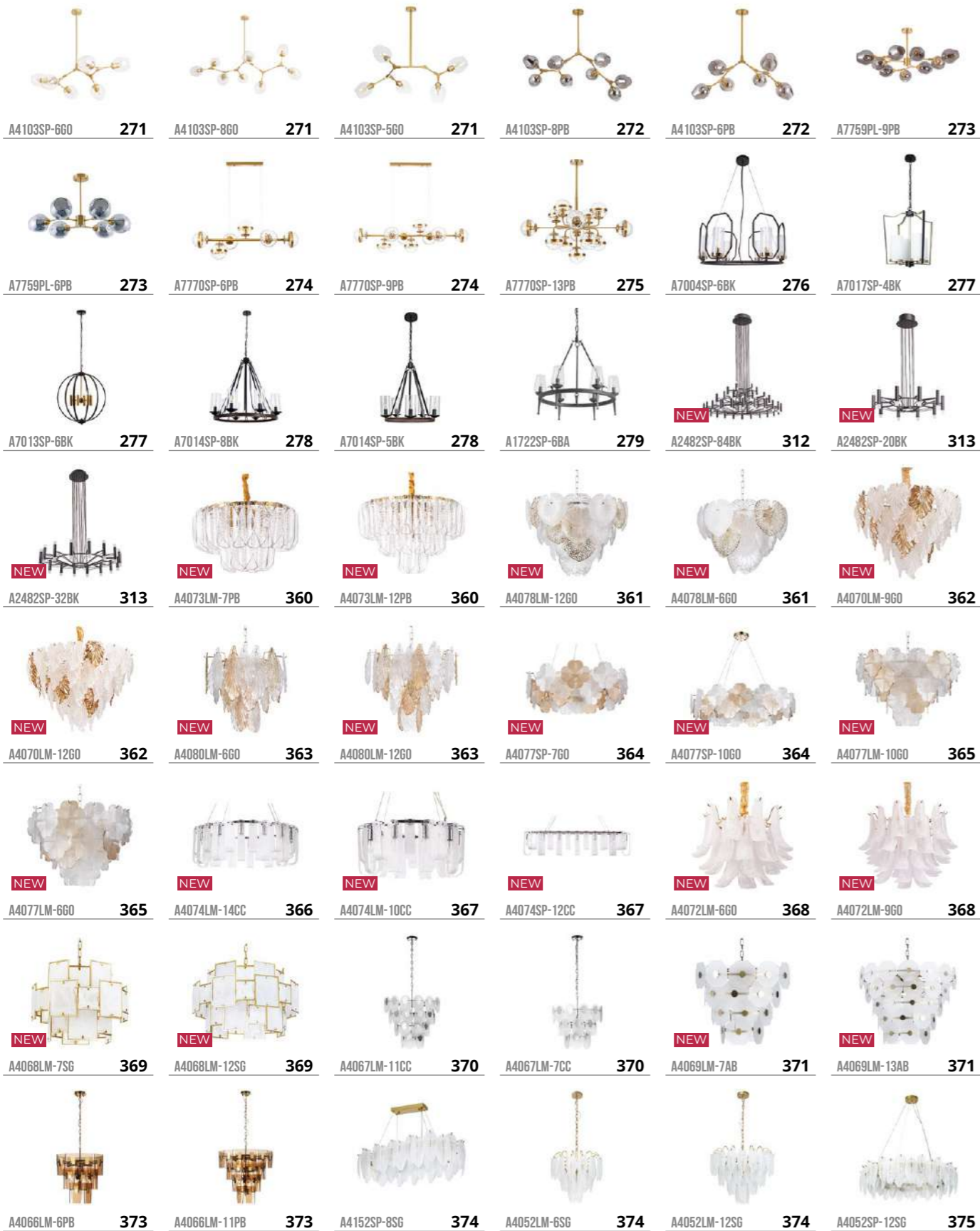

ЛЮСТРЫ ПОДВЕСНЫЕ

CHANDELIERS



ЛЮСТРЫ ПОТОЛОЧНЫЕ

CEILING LAMPS

A1028PL-8BK 153	A1028PL-6BK 153	A1004PL-10SI 167	A1005PL-10GO 176	A1005PL-8GO 176	A1054PL-6CC 177
A1054PL-6GO 177	A1054PL-9CC 177	A1054PL-9GO 177	A4047PL-8CC 182	A4047PL-5CC 182	A4038PL-8CC 183
A4038PL-5CC 183	A7301PL-5PB 188	A7301PL-8PB 188	A4410PL-1SR 195	A4410PL-3SR 195	A7029PL-9BK 219
NEW A7045PL-6BK 221	NEW A7045PL-8BK 221	A1369PL-7SG 228	A2224PL-6BK 230	A2224PL-8BK 230	NEW A2224PL-1PB 231
NEW A2224PL-1BK 231	NEW A2243PL-3PB 257	A6170PL-1GO 262	NEW A2231PL-5PB 264	A7770PL-6PB 275	A7004PL-5BK 276
A7004PL-8BK 276	NEW A2489PL-8GO 304	NEW A2489PL-5GO 304	NEW A2850PL-32PB 309	NEW A2850PL-32BK 310	NEW A2170PL-49BK 322
A2199PL-6BK 323	A2199PL-5BK 323	NEW A2219PL-2BK 326	NEW A2611PL-3BK 346	NEW A2611PL-4BK 346	NEW A2608PL-5BK 347
NEW A2608PL-7BK 347	NEW A2220PL-3WH 348	NEW A2220PL-3GO 348	NEW A2220PL-3BK 348	A2600PL-32BK 349	A2600PL-32GO 349

ЛЮСТРЫ ПОТОЛОЧНЫЕ

CEILING LAMPS

A2607PL-22BK 350	A2607PL-22GO 350	A2607PL-30BK 351	A2607PL-30GO 351	A1363PL-6PB 352	A1363PL-8PB 352
A1364PL-8PB 353	A1364PL-6PB 353	NEW A2211PL-2WH 354	NEW A2211PL-2BK 354	NEW A2426PL-3GO 355	NEW A2426PL-3BK 355
A2848PL-5GO 379	A7410PL-24CC 382	A7410PL-24PB 383	A7410PL-40PB 383	A4207PL-9CC 387	A3479PL-5CC 389
A3479PL-3CC 389	A3479PL-9CC 389	A3479PL-1CC 389	A3459PL-5AB 390	A3459PL-3AB 390	A3459PL-1AB 390
A7274PL-27WH 402	A7274PL-27GO 403	A4524PL-3AB 405	A4577PL-5WG 406	A4577PL-3WG 406	A4577PL-5CK 407
A4577PL-8CK 407	A4577PL-3CK 407				

ПОДВЕСЫ

PENDANT LAMPS



ПОДВЕСЫ

PENDANT LAMPS



ПОДВЕСЫ

PENDANT LAMPS



ПОДВЕСЫ

PENDANT LAMPS



ПОДВЕСЫ

PENDANT LAMPS

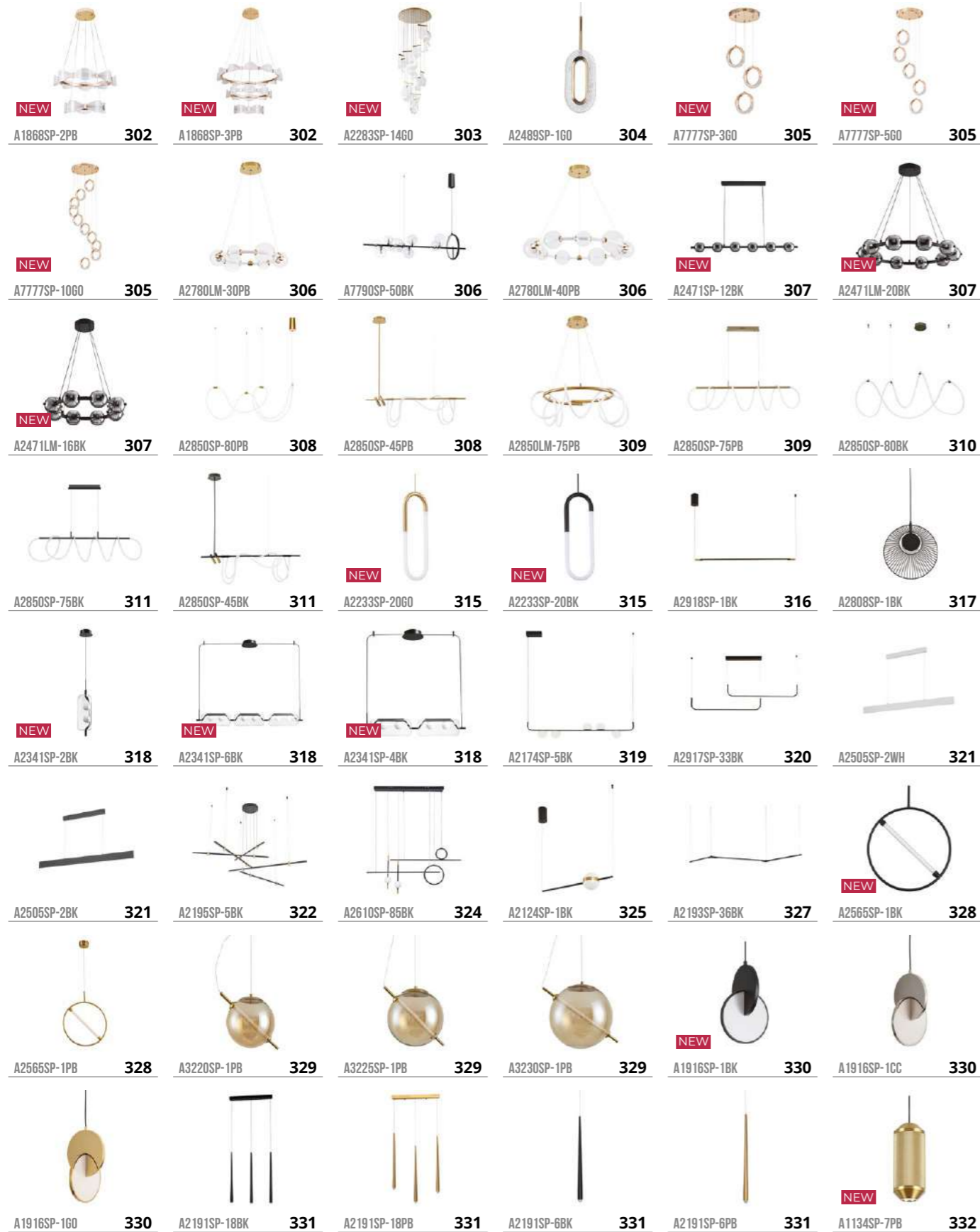

ПОДВЕСЫ

PENDANT LAMPS

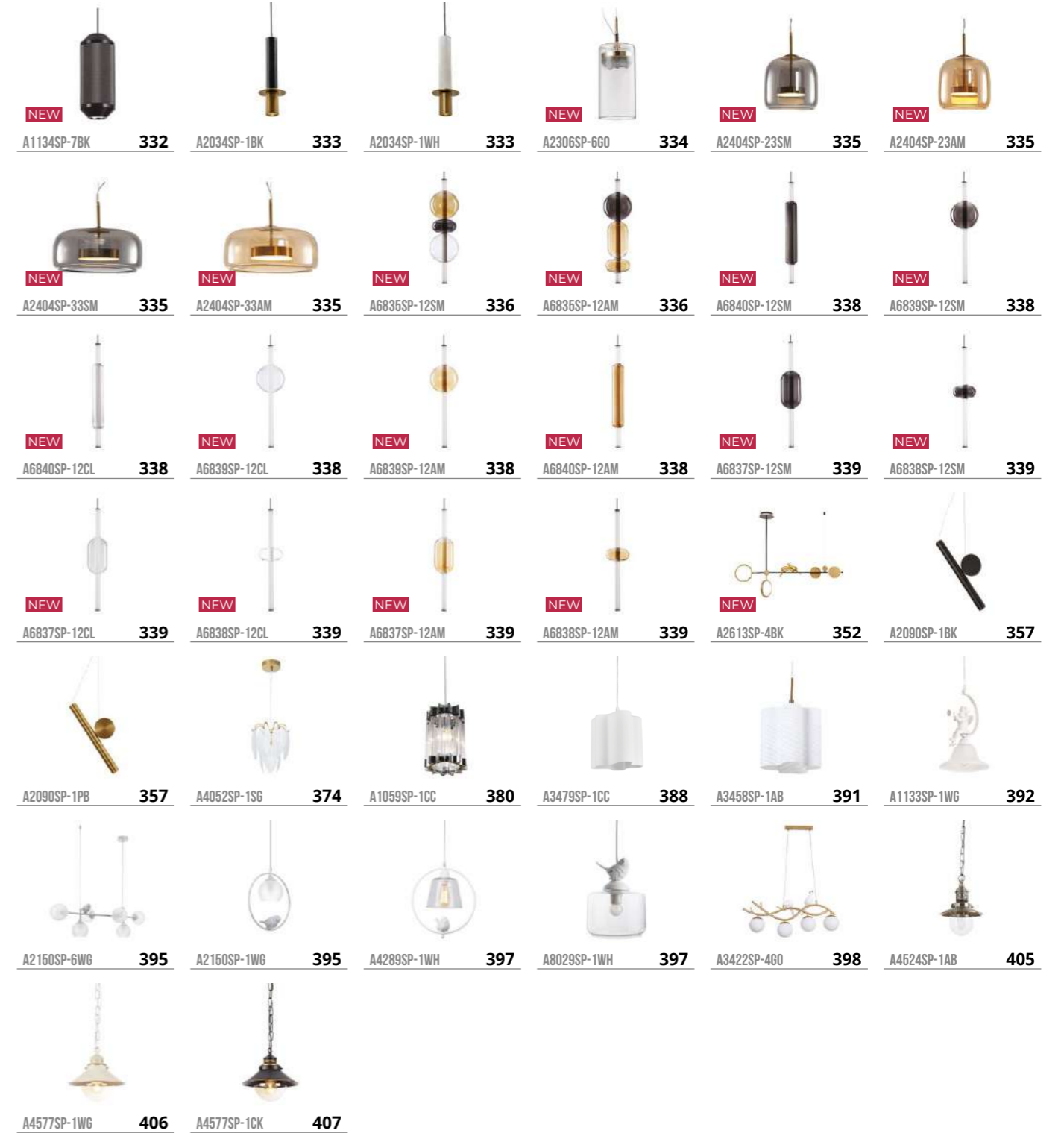

СВЕТИЛЬНИКИ НАСТОЛЬНЫЕ ИНТЕРЬЕРНЫЕ

TABLE LAMPS



СВЕТИЛЬНИКИ НАСТОЛЬНЫЕ ИНТЕРЬЕРНЫЕ

TABLE LAMPS



СВЕТИЛЬНИКИ НАСТОЛЬНЫЕ ИНТЕРЬЕРНЫЕ TABLE LAMPS



СВЕТИЛЬНИКИ НАСТОЛЬНЫЕ ОФИСНЫЕ TABLE LAMPS



СВЕТИЛЬНИКИ НАСТОЛЬНЫЕ ОФИСНЫЕ TABLE LAMPS



СВЕТИЛЬНИКИ НАСТЕННЫЕ WALL LAMPS















































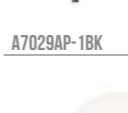

СВЕТИЛЬНИКИ НАСТЕННЫЕ

WALL LAMPS

					
A1408AP-1BK 124	A1408AP-1WH 124	A7009AP-1BC 125	A7009AP-1BK 125	A7009AP-1BR 125	A7009AP-1WH 125
					
A7009AP-1SS 125	A7009AP-1AB 125	A7009AP-1WG 125	A2490AP-1PB 128	A2490AP-1BK 128	A2423AP-5CC 129
					
A2423AP-5PB 129	A2039AP-10BK 130	A2039AP-13BK 130	A2142AP-10BK 131	A2142AP-10PB 131	A2026AP-1BK 132
					
A2025AP-1PB 132	A2025AP-1BK 132	A2027AP-1BK 133	A2027AP-1G0 133	A2027AP-1PB 133	A2027AP-1CC 133
					
A2029AP-1PB 134	A2029AP-1G0 134	A2029AP-1CC 134	A2029AP-1BK 134	A2028AP-1CC 135	A2028AP-1BK 135
					
A2028AP-1PB 135	A2028AP-1G0 135	A2216AP-1WH 136	A2216AP-1BK 136	A2217AP-2WH 137	A2217AP-2BK 137
					
A1043AP-2BK 152	A1028AP-2BK 153	A1037AP-1PB 154	A1039AP-2BK 155	A1049AP-2G0 156	A1053AP-2PB 157
					
A1034AP-2CC 158	A1007AP-2G0 159	A1064AP-2CC 160	A1063AP-2CC 161	A1063AP-2AB 161	A1052AP-2G0 162

СВЕТИЛЬНИКИ НАСТЕННЫЕ

WALL LAMPS

					
A1051AP-2CC 163	A1009AP-2CC 166	A1008AP-2G0 168	A1002AP-2CC 169	A1062AP-2CC 170	A1006AP-2CC 171
					
A1003AP-1CC 173	A2719AP-2CC 174	A2719AP-2G0 175	A1005AP-2G0 176	A1054AP-1CC 177	A1054AP-1G0 177
					
A4079AP-1CC 178	A4076AP-1CC 179	A3990AP-1CC 181	A4047AP-1CC 182	A4038AP-1CC 183	A5896AP-1CC 185
					
A5896AP-1PB 185	A4027AP-1PB 186	A8555AP-2AB 187	A7301AP-1PB 188	A4075AP-1BK 191	A9310AP-1WG 193
					
A4410AP-1SR 195	A3579AP-1AB 196	A9518AP-1BA 198	A3777AP-1AB 199	A6905AP-1AB 200	A6097AP-1PB 203
					
A3143AP-2BK 207	A3143AP-2PB 208	A7033AP-1BK 218	A7029AP-1BK 219	A7620AP-1AB 220	A7045AP-1BK 221
					
A7780AP-2AB 222	A7780AP-1AB 223	A7790AP-1G0 224	A7790AP-1BK 226	A2224AP-1BK 230	A1664AP-1G0 232
					
A1664AP-1CC 233	A1664AP-1BK 234	A1921AP-1CC 242	A1924AP-1CC 242	A1921AP-1AB 245	A1924AP-1AB 245

СВЕТИЛЬНИКИ НАСТЕННЫЕ

WALL LAMPS

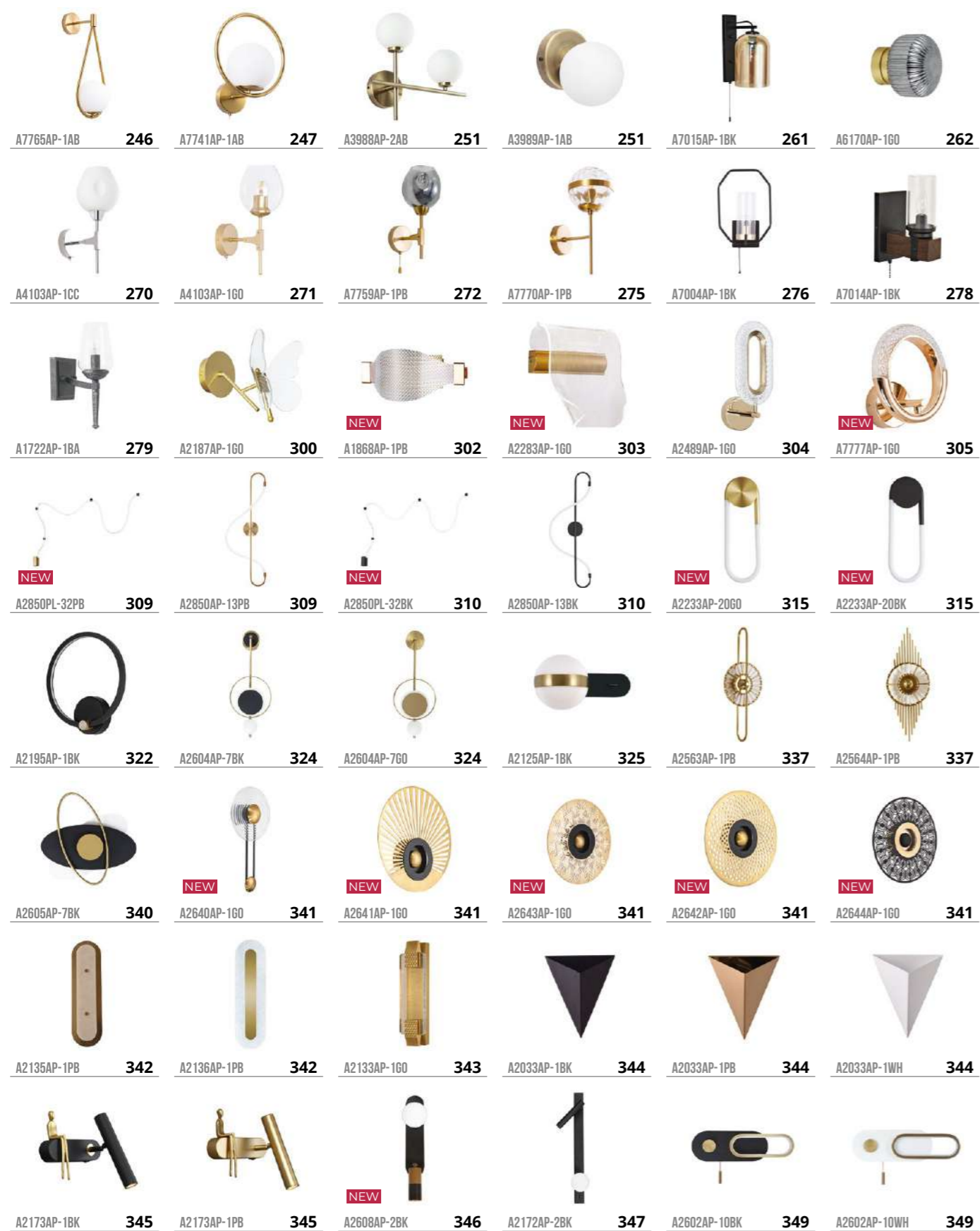

СВЕТИЛЬНИКИ НАСТЕННЫЕ

WALL LAMPS

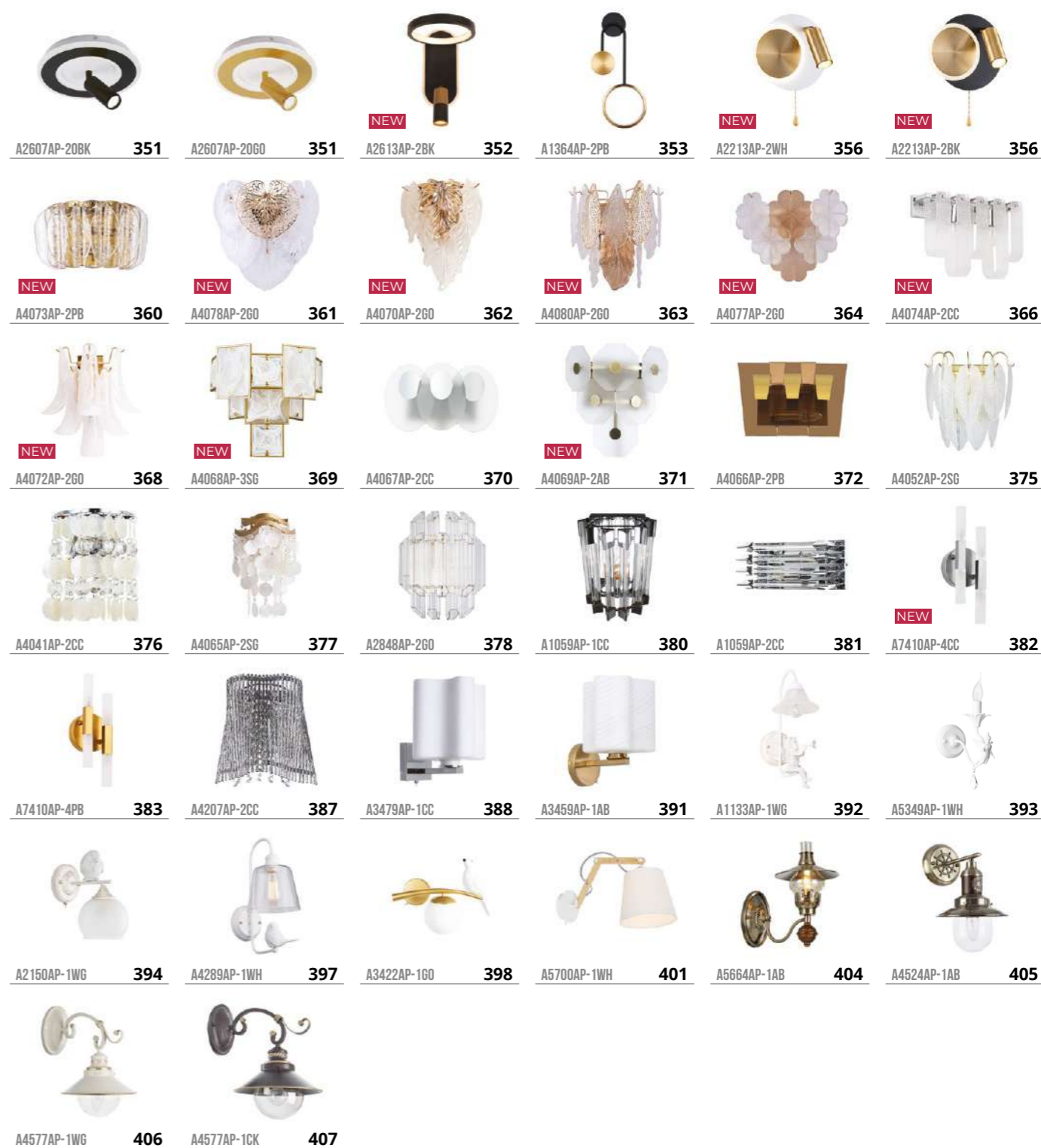

















































ПОДСВЕТКА ДЛЯ КАРТИН И ЗЕРКАЛ

MIRROR AND PICTURE LAMPS

					
A6508AP-1AB 138	A6512AP-1AB 138	A8046AP-1PB 139	A8048AP-1PB 139	A6708AP-1AB 140	A6712AP-1AB 140
					
A6308AP-1AB 141	A6312AP-1AB 141	A7908AP-1BK 142	A7912AP-1BK 142	A1709AP-1AB 143	A1709AP-1BK 143
					
A1709AP-1CC 143	A1709AP-1G0 143	A1711AP-1AB 143	A1711AP-1BK 143	A1711AP-1CC 143	A1711AP-1G0 143
					
A5308AP-1CC 144	A5312AP-1CC 144	A5308AP-1WH 144	A5312AP-1WH 144	A7708AP-1BK 144	A7712AP-1BK 144
					
A7031AP-1CC 145	A7031AP-1AB 145	A8025AP-1G0 147	A8025AP-1BK 147	A8025AP-1CC 147	A8025AP-1WH 147
					
A8025AP-1PB 147	A8027AP-1G0 147	A8027AP-1BK 147	A8027AP-1CC 147	A8027AP-1WH 147	A8027AP-1PB 147
					
A5023AP-1AB 148	A5009AP-2AB 149				

СВЕТИЛЬНИКИ НАПОЛЬНЫЕ

FLOOR LAMPS

					
A2054PN-1BK 98	A2054PN-1AB 98	A2054PN-1WH 98	NEW A5039PN-1CC 100	NEW A5039PN-1AB 101	A2581PN-1CC 102
					
A2581PN-2CC 102	A2581PN-1AB 103	A2581PN-2AB 103	A5031PN-1PB 104	A5031PN-1SS 104	NEW A5037PN-2CC 105
					
A5029PN-1SS 106	A2589PN-1SS 107	A1021PN-1SS 109	A5024PN-1PB 110	A4031PN-1PB 111	A1509PN-1PB 113
					
A4048PN-1CC 114	A4023PN-1CC 115	A4054PN-1PB 116	A4060PN-1CC 117	A4060PN-1PB 117	A5822PN-1SS 117
					
A5822PN-1PB 117	A2487PN-1BK 118	A2487PN-1WH 118	A4329PN-2AB 119	A4329PN-2CC 119	A9569PN-2AB 119
					
A9569PN-2SS 119	A9569PN-2BK 119	A4055PN-1BK 120	A4056PN-1WH 120	A2070PN-1BK 120	A4053PN-1BK 121
					
A2102PN-1WH 121	A3990PN-1CC 181	A5896PN-1PB 184	A5896PN-1CC 184	A7301PN-1PB 189	A3579PN-3AB 197
					
A7033PN-1BK 218	NEW A2224PN-2BK 231	A1921PN-1CC 242	A1921PN-1AB 244	NEW A2243PN-6PB 257	A2850PN-35PB 309

СВЕТИЛЬНИКИ НАПОЛЬНЫЕ FLOOR LAMPS

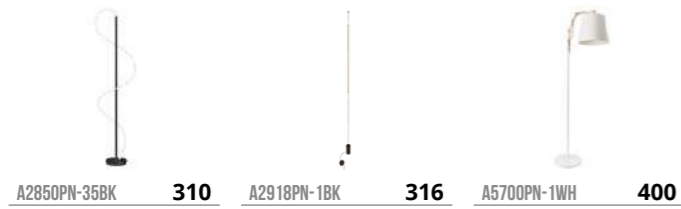

СПОТЫ SPOTS



СПОТЫ SPOTS

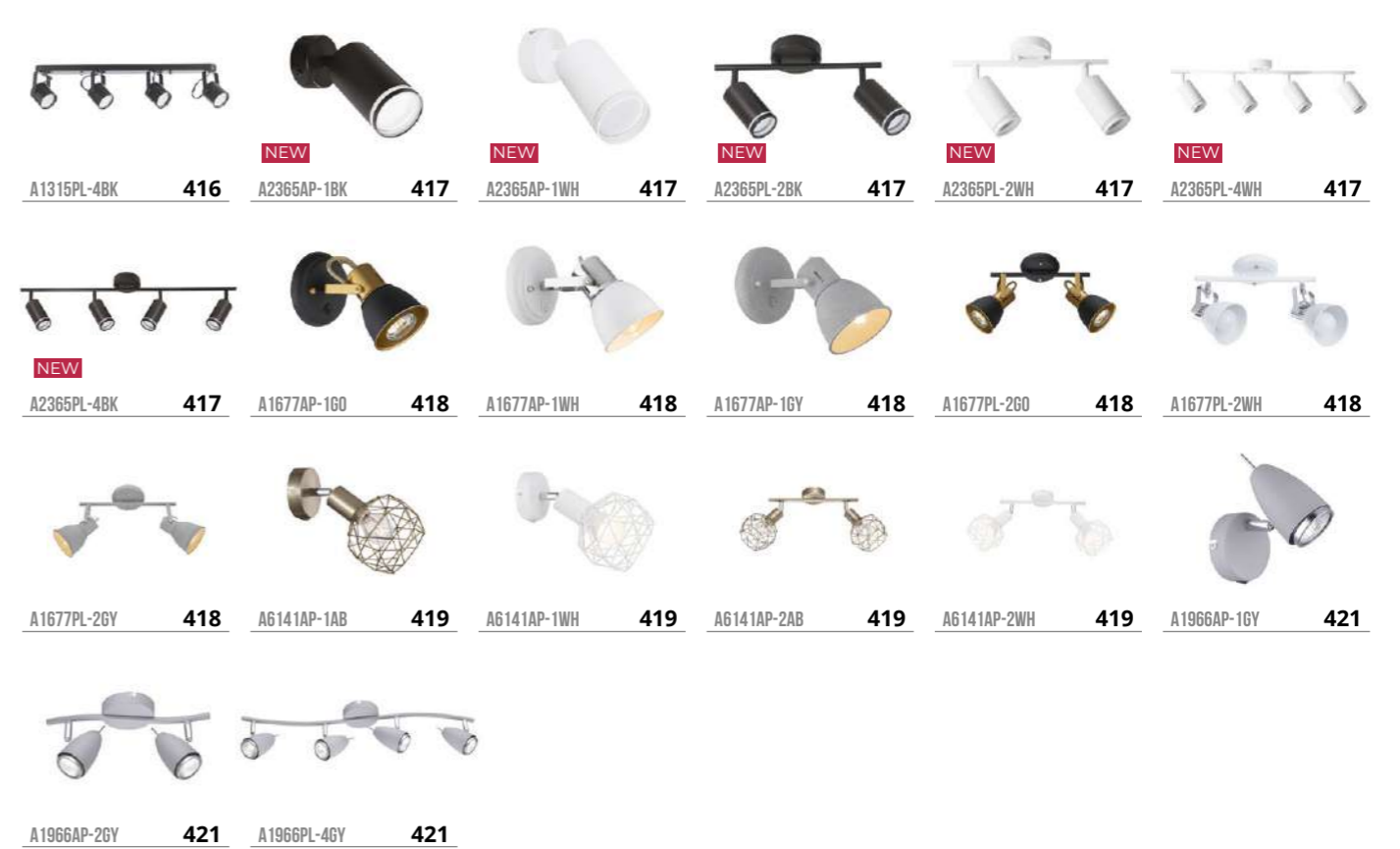

СВЕТИЛЬНИКИ ДЛЯ ВАННЫХ КОМНАТ BATH LAMPS



СВЕТИЛЬНИКИ ДЛЯ ВАННЫХ КОМНАТ BATH LAMPS



СВЕТИЛЬНИКИ УЛИЧНЫЕ ДЕКОРАТИВНЫЕ OUTDOOR DECORATIVE



СВЕТИЛЬНИКИ УЛИЧНЫЕ ДЕКОРАТИВНЫЕ OUTDOOR DECORATIVE



СВЕТИЛЬНИКИ УЛИЧНЫЕ ДЕКОРАТИВНЫЕ

OUTDOOR DECORATIVE

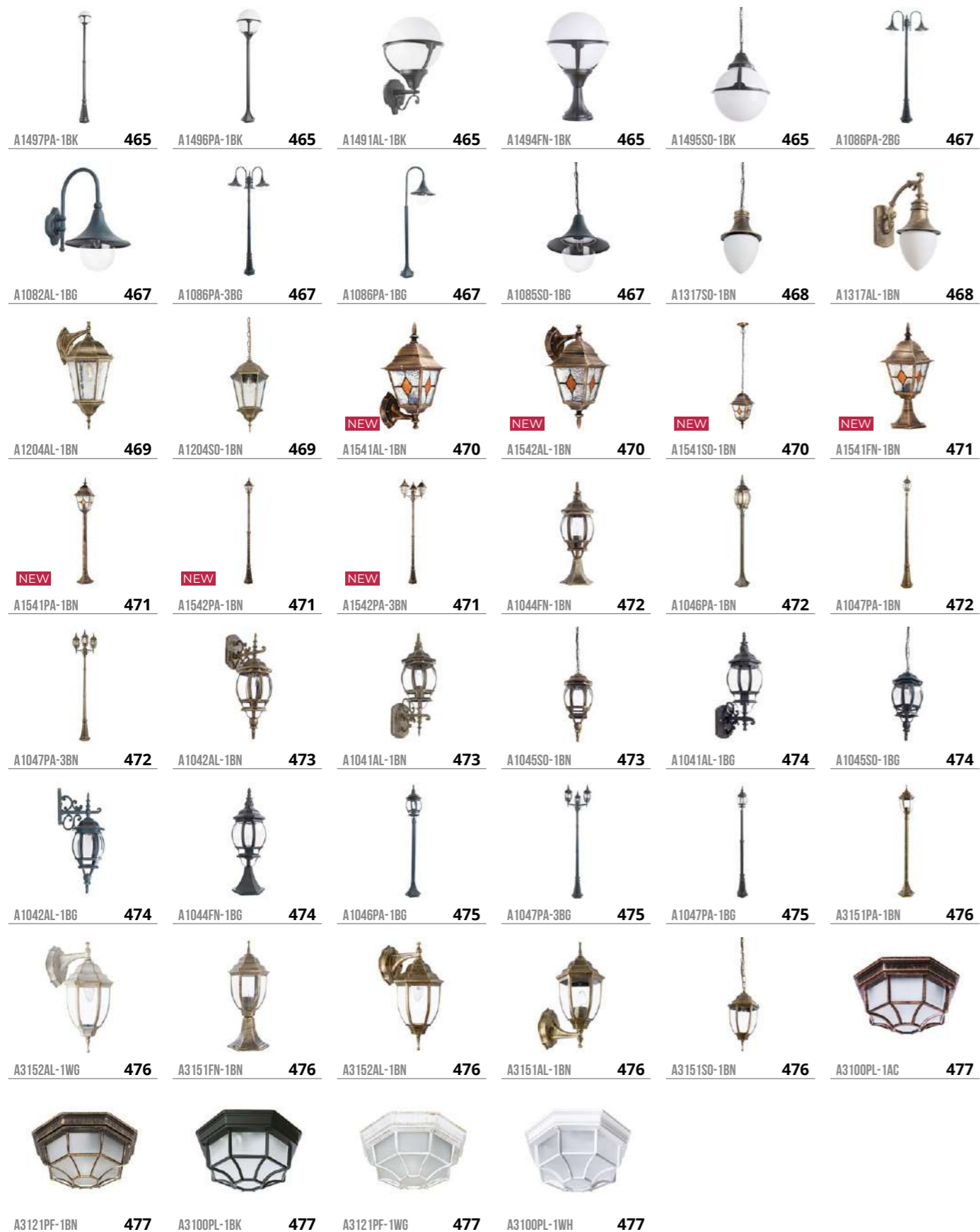

СВЕТИЛЬНИКИ УЛИЧНЫЕ АРХИТЕКТУРНЫЕ

OUTDOOR ARCHITECTURAL



КОМПЛЕКТУЮЩИЕ

ACCESSORIES





Comfort zone

все иллюстрации созданы инструментами нейросети
#Midjourney



NEW
A5052LT-1CC

↓ 66 ∅38
⊙ 60W | E27
⌘ 180

Fixture material: metal plated, glass
Fixture colour: chrome
Shade material: fabric
Shade colour: white

Материал арматуры: металл
гальванизированный, стекло
Цвет арматуры: хром
Материал плафона: ткань
Цвет плафона: белый



NEW
A5051LT-1PB

↓ 65 ∅38
⊙ 60W | E27
⌘ 180

Fixture material: metal plated, glass
Fixture colour: polished brass
Shade material: fabric
Shade colour: white

Материал арматуры: металл
гальванизированный, стекло
Цвет арматуры: полированная медь
Материал плафона: ткань
Цвет плафона: белый



SAIPH



NEW
A5046LT-1BK

↑ 61 ∅ 30
♀ 60W | E27
Ψ 180

Fixture material: metal plated, glass
Fixture colour: black
Shade material: fabric
Shade colour: white

Материал арматуры: металл гальванизированный, стекло
Цвет арматуры: черный
Материал плафона: ткань
Цвет плафона: белый



NEW
A5043LT-1WH

↑ 65 ∅ 35
♀ 60W | E27
Ψ 180



NEW
A5043LT-1BK

↑ 65 ∅ 35
♀ 60W | E27
Ψ 180

Fixture material: metal plated, glass
Fixture colour: black / white
Shade material: fabric
Shade colour: white

Материал арматуры: металл гальванизированный, стекло
Цвет арматуры: черный / белый
Материал плафона: ткань
Цвет плафона: белый

NAOS





A1670LT-1PB

↑ 52 Ø 30
 ♀ 60W | E27
 Ψ 180



A5070LT-1PB

↑ 49 Ø 30
 ♀ 60W | E27
 Ψ 180



A5059LT-1PB

↑ 56 Ø 35
 ♀ 60W | E27
 Ψ 180



A5017LT-1PB

↑ 63 Ø 38
 ♀ 60W | E27
 Ψ 180

Fixture material: metal plated, crystal /
 metal plated, glass
 Fixture colour: polished brass
 Shade material: fabric
 Shade colour: white / cream

Материал арматуры: металл
 гальванизированный, хрусталь / металл
 гальванизированный, стекло
 Цвет арматуры: полированная медь
 Материал плафона: ткань
 Цвет плафона: белый / кремовый

NEKKAR



NEW

A5045LT-1PB

↑ 54 Ø 33
 ♀ 60W | E27
 Ψ 180

Fixture material: metal plated, glass
 Fixture colour: polished brass
 Shade material: fabric
 Shade colour: white

Материал арматуры: металл
 гальванизированный, стекло
 Цвет арматуры: полированная медь
 Материал плафона: ткань
 Цвет плафона: белый

NEW

A5044LT-1PB

↑ 53 Ø 35
 ♀ 60W | E27
 Ψ 180



Fixture material: metal plated, glass
 Fixture colour: polished brass
 Shade material: fabric
 Shade colour: white

Материал арматуры: металл
 гальванизированный, стекло
 Цвет арматуры: полированная медь
 Материал плафона: ткань
 Цвет плафона: белый

PLEIONE

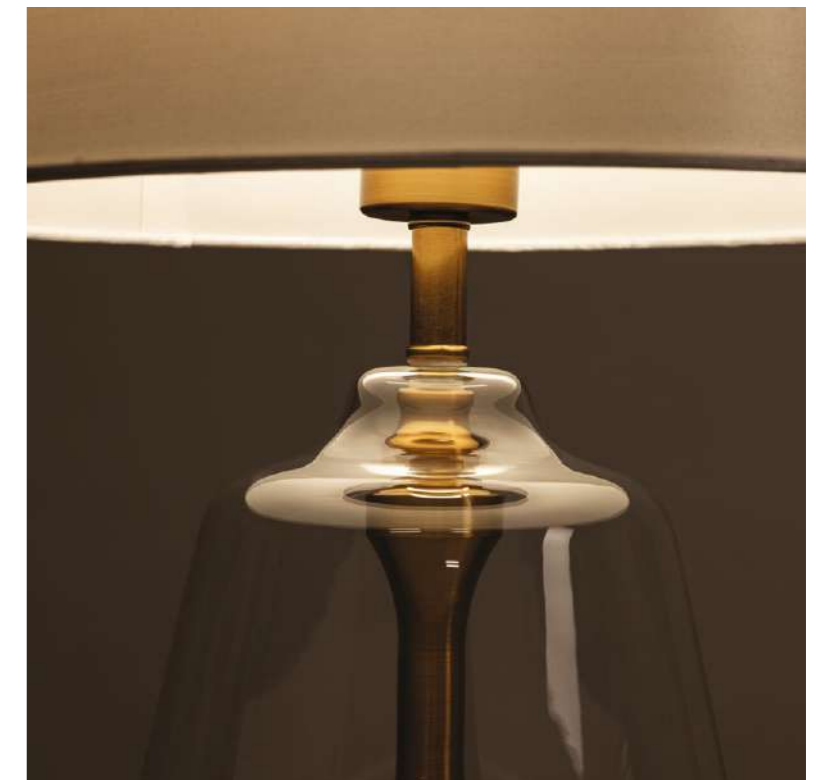



NEW
A5053LT-1PB

↑ 61 ∅ 32
♀ 60W | E27
Ψ 180

Fixture material: metal plated, glass
Fixture colour: polished brass
Shade material: fabric
Shade colour: white

Материал арматуры: металл
гальванизированный, стекло
Цвет арматуры: полированная медь
Материал плафона: ткань
Цвет плафона: белый



NEW
A4062LT-1CC

↑ 63 ∅ 35
♀ 60W | E27
Ψ 180

Fixture material: metal plated, glass
Fixture colour: polished brass / chrome
Shade material: fabric
Shade colour: beige / white

Материал арматуры: металл гальванизированный, стекло
Цвет арматуры: полированная медь / хром
Материал плафона: ткань
Цвет плафона: бежевый / белый



A4062LT-1PB

↑ 65 ∅ 35
♀ 60W | E27
Ψ 180

MAIA



A4036LT-1GO

↑ 50 ∅ 30
♀ 60W | E27
Ψ 180

Fixture material: metal plated, glass
Fixture colour: gold
Shade material: fabric
Shade colour: white

Материал арматуры: металл
гальванизированный, стекло
Цвет арматуры: золото
Материал плафона: ткань
Цвет плафона: белый



JESSICA





A1550LT-1PB

↑ 54 Ø 32
♀ 60W | E27
Ψ 180



A2020LT-1PB

↑ 66 Ø 40
♀ 60W | E27
Ψ 180

Fixture material: metal plated, glass
Fixture colour: polished brass
Shade material: fabric
Shade colour: cream

Материал арматуры: металл гальванизированный, стекло
Цвет арматуры: полированная медь
Материал плафона: ткань
Цвет плафона: кремовый



Fixture material: metal plated, glass
Fixture colour: chrome
Shade material: fabric
Shade colour: brown / smoky

Материал арматуры: металл гальванизированный, стекло
Цвет арматуры: хром
Материал плафона: ткань
Цвет плафона: коричневый / дымчатый

SHELDON



A8531LT-1CC

↑ 68 Ø 42
♀ 60W | E27
Ψ 180



A8532LT-1CC

↑ 68 Ø 42
♀ 60W | E27
Ψ 180



Fixture material: metal plated, glass
 Fixture colour: gold / chrome
 Shade material: fabric
 Shade colour: beige / black

Материал арматуры: металл гальванизированный, стекло
 Цвет арматуры: золото / хром
 Материал плафона: ткань
 Цвет плафона: бежевый / черный



A4029LT-1CC

↓ 49 ∅ 30
 ♀ 60W | E27
 ☿ 180



A4029LT-1GO

↓ 49 ∅ 30
 ♀ 60W | E27
 ☿ 180



A4025LT-1PB

↓ 45 ∅ 23
 ♀ 40W | E14
 ☿ 180

MUSICA

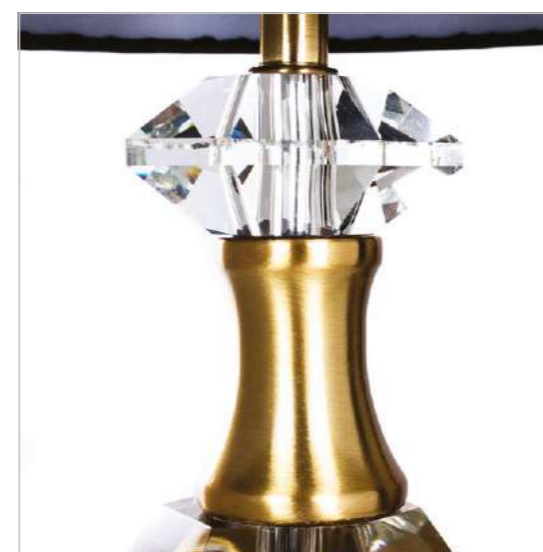

Fixture material: metal plated, crystal
 Fixture colour: polished brass
 Shade material: fabric
 Shade colour: black

Материал арматуры: металл гальванизированный, хрусталь
 Цвет арматуры: полированная медь
 Материал плафона: ткань
 Цвет плафона: черный





A4019LT-1CC

↑ 39 Ø 25
 ♀ 40W | E14
 ☿ 180

Fixture material: metal plated, crystal
 Fixture colour: chrome
 Shade material: fabric
 Shade colour: white

Материал арматуры: металл
 гальванизированный, хрусталь
 Цвет арматуры: хром
 Материал плафона: ткань
 Цвет плафона: белый

LOUIS



A4017LT-1CC

↑ 23 Ø 14
 ♀ 40W | E14
 ☿ 180

Fixture material: metal plated, crystal
 Fixture colour: chrome

Материал арматуры: металл
 гальванизированный, хрусталь
 Цвет арматуры: хром

CAPELLA



A4024LT-1CC

↑ 41 Ø 23
 ♀ 40W | E14
 ☿ 180

Fixture material: metal plated, crystal
 Fixture colour: chrome
 Shade material: fabric
 Shade colour: gray

Материал арматуры: металл
 гальванизированный, хрусталь
 Цвет арматуры: хром
 Материал плафона: ткань
 Цвет плафона: серый



A4022LT-1CC

↑ 39 ↔ 24 ↗ 16
 ♀ 40W | E14
 ☿ 180

Fixture material: metal plated, crystal
 Fixture colour: chrome
 Shade material: fabric
 Shade colour: white

Материал арматуры: металл
 гальванизированный, хрусталь
 Цвет арматуры: хром
 Материал плафона: ткань
 Цвет плафона: белый

CLINT





Fixture material: ceramics
 Fixture colour: white
 Shade material: fabric
 Shade colour: white

Материал арматуры: керамика
 Цвет арматуры: белый
 Материал плафона: ткань
 Цвет плафона: белый



NEW

A3463LT-1WH

↓ 21 ∅ 13
 ∅ 40W | E14
 √ 130



A4061LT-1CC

↓ 58 ∅ 38
 ∅ 40W | E27
 √ 130



A4061LT-1PB

↓ 58 ∅ 38
 ∅ 40W | E27
 √ 130

SARIN



A4311LT-1WH

↓ 45 ∅ 25
 ∅ 40W | E27
 √ 130

Fixture material: ceramics
 Fixture colour: white
 Shade material: fabric
 Shade colour: white

Материал арматуры: керамика
 Цвет арматуры: белый
 Материал плафона: ткань
 Цвет плафона: белый

SHAULA

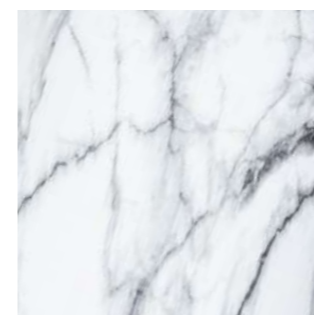

Fixture material: metal plated,
 ceramics
 Fixture colour: chrome / polished
 brass
 Shade material: fabric
 Shade colour: белый / бежевый

Материал арматуры: металл
 гальванизированный, керамика
 Цвет арматуры: хром /
 полированная медь
 Материал плафона: ткань
 Цвет плафона: белый / бежевый





NEW

A5034LT-1WH

↑ 30 ∅ 18
♀ 40W | E14
Ψ 130

Fixture material: ceramics
Fixture colour: white
Shade material: fabric
Shade colour: белый

Материал арматуры: керамика
Цвет арматуры: белый
Материал плафона: ткань
Цвет плафона: белый

ZIBAL



NEW

A5005LT-1WH

↑ 25 ∅ 16
♀ 40W | E14
Ψ 130

Fixture material: ceramics
Fixture colour: white
Shade material: fabric
Shade colour: белый

Материал арматуры: керамика
Цвет арматуры: белый
Материал плафона: ткань
Цвет плафона: белый

WURREN



NEW

A5016LT-1WH

↑ 25 ∅ 16
♀ 40W | E14
Ψ 130

Fixture material: ceramics
Fixture colour: white
Shade material: fabric
Shade colour: белый

Материал арматуры: керамика
Цвет арматуры: белый
Материал плафона: ткань
Цвет плафона: белый



NEW

A5022LT-1GY

↑ 25 ∅ 16
♀ 40W | E14
Ψ 130

Fixture material: ceramics
Fixture colour: gray
Shade material: fabric
Shade colour: белый

Материал арматуры: керамика
Цвет арматуры: серый
Материал плафона: ткань
Цвет плафона: белый

TITAWIN





NEW
A5033LT-1WH

↑ 28 ∅ 20
⊙ 40W | E14
Ψ 130

Fixture material: ceramics
Fixture colour: white
Shade material: fabric
Shade colour: белый

Материал арматуры: керамика
Цвет арматуры: белый
Материал плафона: ткань
Цвет плафона: белый

TIAKI



NEW
A4636LT-1GY

↑ 27 ∅ 18
⊙ 40W | E14
Ψ 130

Fixture material: ceramics
Fixture colour: gray
Shade material: fabric
Shade colour: gray

Материал арматуры: керамика
Цвет арматуры: серый
Материал плафона: ткань
Цвет плафона: серый

BUNDA



A4007LT-1WH

↑ 29 ∅ 15
⊙ 40W | E14
Ψ 130



A4007LT-1GY

↑ 29 ∅ 15
⊙ 40W | E14
Ψ 130

Fixture material: ceramics
Fixture colour: white / gray
Shade material: fabric
Shade colour: gray / white

Материал арматуры: керамика
Цвет арматуры: белый / серый
Материал плафона: ткань
Цвет плафона: серый / белый



A4429LT-1BA

↑ 29 ↔ 13 ∇ 11
⊙ 40W | E14
Ψ 130

Fixture material: ceramics
Fixture colour: white / gray
Shade material: fabric
Shade colour: gray / white

Материал арматуры: керамика
Цвет арматуры: белый / серый
Материал плафона: ткань
Цвет плафона: серый / белый



A4429LT-1WA

↑ 29 ↔ 13 ∇ 11
⊙ 40W | E14
Ψ 130

FIORI





A4272LT-1GY

↑ 43 ∅ 25
♀ 40W | E27
ϕ 130

Fixture material: ceramics
Fixture colour: gray
Shade material: fabric
Shade colour: gray

Материал арматуры: керамика
Цвет арматуры: серый
Материал плафона: ткань
Цвет плафона: серый



A4237LT-1GY

↑ 40 ∅ 25
♀ 40W | E27
ϕ 130

Fixture material: ceramics
Fixture colour: gray
Shade material: fabric
Shade colour: white

Материал арматуры: керамика
Цвет арматуры: серый
Материал плафона: ткань
Цвет плафона: белый

TWILLY

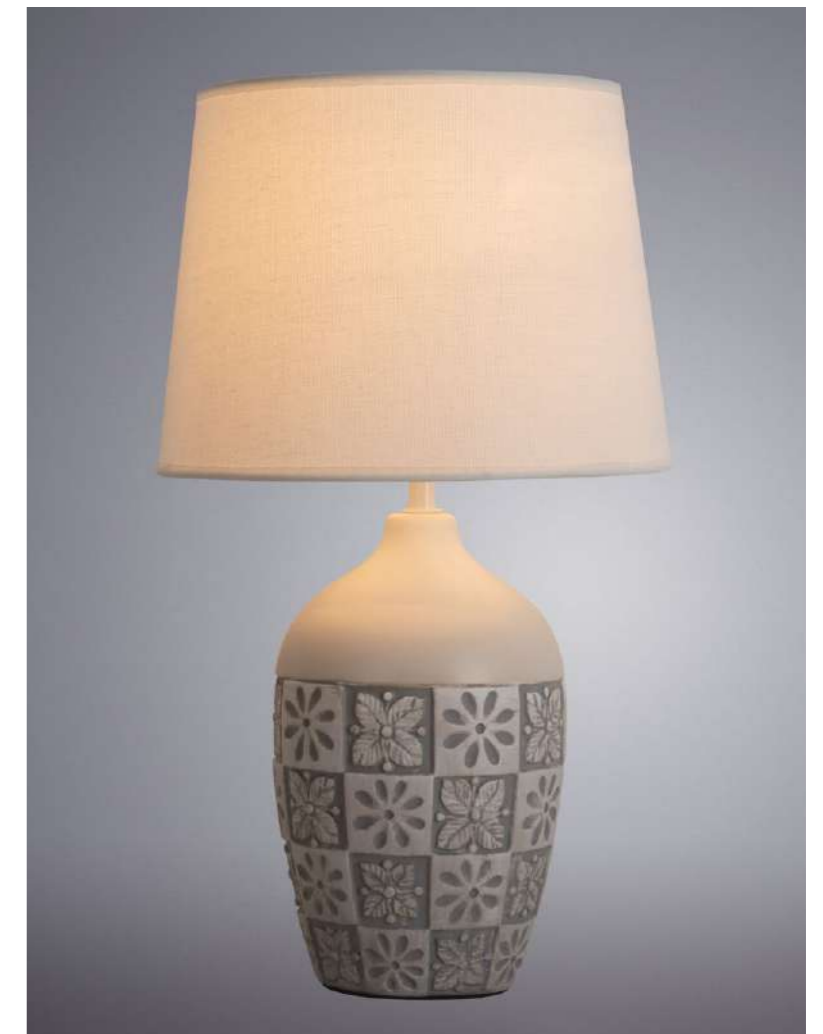



Fixture material: ceramics
 Fixture colour: chrome / gold
 Shade material: fabric
 Shade colour: белый

Материал арматуры: керамика
 Цвет арматуры: хром / золото
 Материал плафона: ткань
 Цвет плафона: белый



NEW
A5035LT-1CC
 ↑ 29 ∅ 18
 ♀ 40W | E14
 ⚗ 130



NEW
A5035LT-1GO
 ↑ 29 ∅ 18
 ♀ 40W | E14
 ⚗ 130



A4063LT-1CC
 ↑ 34 ↔ 25 ∇ 18
 ♀ 40W | E14
 ⚗ 130



A4063LT-1GO
 ↑ 34 ↔ 25 ∇ 18
 ♀ 40W | E14
 ⚗ 130

POPPY



Fixture material: ceramics
 Fixture colour: gold / chrome
 Shade material: fabric
 Shade colour: white

Материал арматуры: керамика
 Цвет арматуры: золото / хром
 Материал плафона: ткань
 Цвет плафона: белый





A4003LT-1CC

↑ 40 ∅ 25
♀ 40W | E27
ϕ 130



A4003LT-1GO

↑ 40 ∅ 25
♀ 40W | E27
ϕ 130

KORFU



A4001LT-1CC

↑ 26 ∅ 16
♀ 40W | E14
ϕ 130



A4001LT-1GO

↑ 26 ∅ 16
♀ 40W | E14
ϕ 130

Fixture material: ceramics / aluminum
Fixture colour: gold / chrome / white
Shade material: fabric
Shade colour: black / white

Материал арматуры: керамика / алюминий
Цвет арматуры: золото / хром / белый
Материал плафона: ткань
Цвет плафона: черный / белый



Fixture material: ceramics
Fixture colour: gold / chrome
Shade material: fabric
Shade colour: beige / white

Материал арматуры: керамика
Цвет арматуры: золото / хром
Материал плафона: ткань
Цвет плафона: бежевый / белый





A4016LT-1BK

↑ 46 ∅ 30
♀ 40W | E27
Ψ 130



A4016LT-1WH

↑ 46 ∅ 30
♀ 40W | E27
Ψ 130

Fixture material: metal plated, ceramics
Fixture colour: white / black
Shade material: fabric
Shade colour: white / black

Материал арматуры: металл
гальванизированный, керамика
Цвет арматуры: белый / черный
Материал плафона: ткань
Цвет плафона: белый / черный

REVATI



A4002LT-1CC

↑ 58 ∅ 30
♀ 40W | E27
Ψ 130



A4002LT-1GO

↑ 58 ∅ 30
♀ 40W | E27
Ψ 130

Fixture material: ceramics
Fixture colour: chrome / gold
Shade material: fabric
Shade colour: white / black

Материал арматуры: керамика
Цвет арматуры: хром / золото
Материал плафона: ткань
Цвет плафона: белый / черный





A2230LT-1PB

↑ 67 ↔ 30 ↗ 43
 ♀ 60W | E27
 ⚡ 180



A4032LT-1GO

↑ 67 ∅ 36
 ♀ 60W | E27
 ⚡ 180



A4035LT-1GO

↑ 49 ∅ 28
 ♀ 60W | E27
 ⚡ 180

FIRE



Fixture material: metal plated
 Fixture colour: polished brass
 Shade material: fabric
 Shade colour: beige

Материал арматуры: металл
 гальванизированный
 Цвет арматуры:
 полированная медь
 Материал плафона: ткань
 Цвет плафона: бежевый



Fixture material: metal plated, marble
 Fixture colour: gold
 Shade material: fabric
 Shade colour: black / white

Материал арматуры: металл
 гальванизированный, мрамор
 Цвет арматуры: золото
 Материал плафона: ткань
 Цвет плафона: черный / белый





NEW
A5055LT-1PB
 ↑ 57 ↔ 36 ↗ 23
 ♀ 60W | E27
 ⚡ 180



Fixture material: metal plated, marble
 Fixture colour: polished brass
 Shade material: fabric
 Shade colour: beige
 Материал арматуры: металл гальванизированный, мрамор
 Цвет арматуры: полированная медь
 Материал плафона: ткань
 Цвет плафона: бежевый



A4501LT-1PB
 ↑ 65 ↔ 25 ↗ 36
 ♀ 60W | E27
 ⚡ 180

CAMELOT



Fixture material: metal plated, marble
 Fixture colour: polished brass
 Shade material: fabric
 Shade colour: beige
 Материал арматуры: металл гальванизированный, мрамор
 Цвет арматуры: полированная медь
 Материал плафона: ткань
 Цвет плафона: бежевый

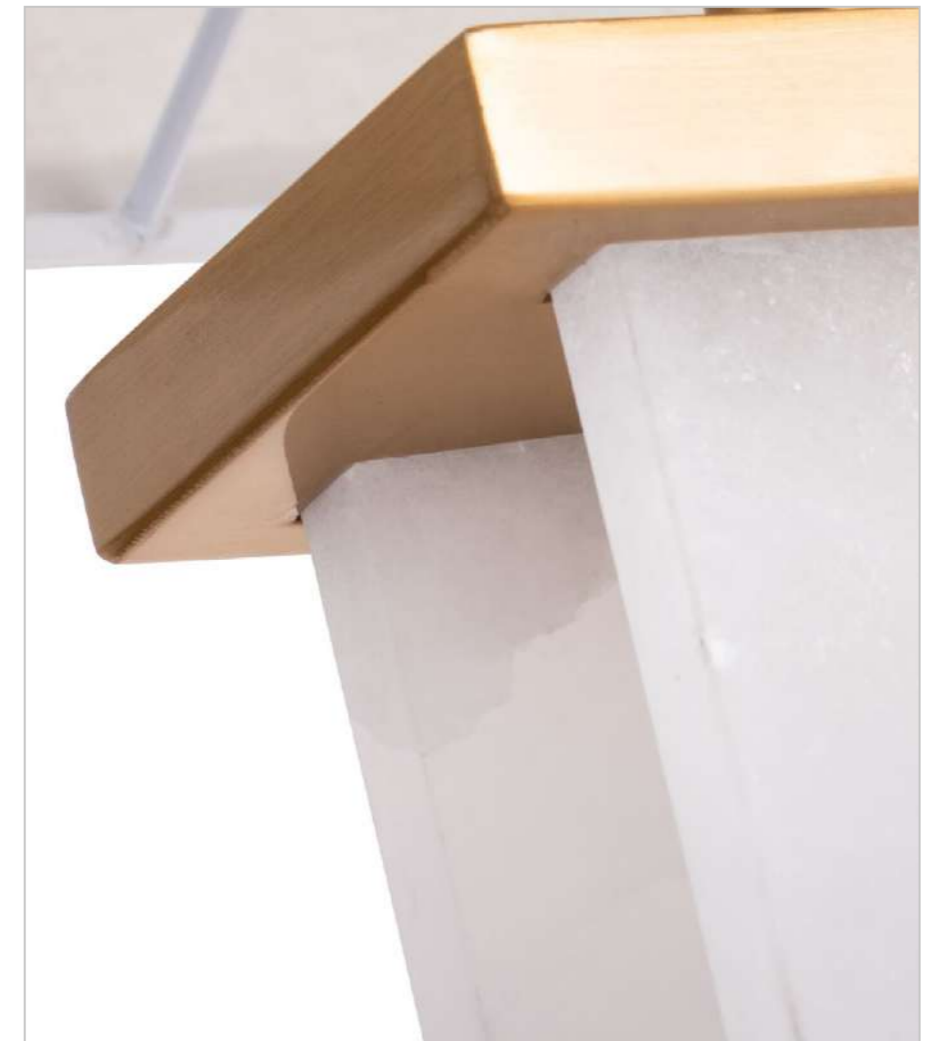



A4028LT-1PB

↑ 60 Ø 36
 ♀ 60W | E27
 ☿ 180

Fixture material: metal plated, marble
 Fixture colour: polished brass
 Shade material: fabric
 Shade colour: white

Материал арматуры: металл
 гальванизированный, мрамор
 Цвет арматуры: полированная медь
 Материал плафона: ткань
 Цвет плафона: белый



NEW

A5054LT-1PB

↑ 63 Ø 36
 ♀ 60W | E27
 ☿ 180

TIANYI

RAMADA



A3588LT-1PB

↑ 68 Ø 40
 ♀ 60W | E27
 ☿ 180

Fixture material: metal plated, marble
 Fixture colour: polished brass
 Shade material: fabric
 Shade colour: beige

Материал арматуры: металл
 гальванизированный, мрамор
 Цвет арматуры: полированная медь
 Материал плафона: ткань
 Цвет плафона: бежевый

Fixture material: metal plated, marble
 Fixture colour: polished brass
 Shade material: fabric
 Shade colour: white

Материал арматуры: металл
 гальванизированный, мрамор
 Цвет арматуры: полированная медь
 Материал плафона: ткань
 Цвет плафона: белый

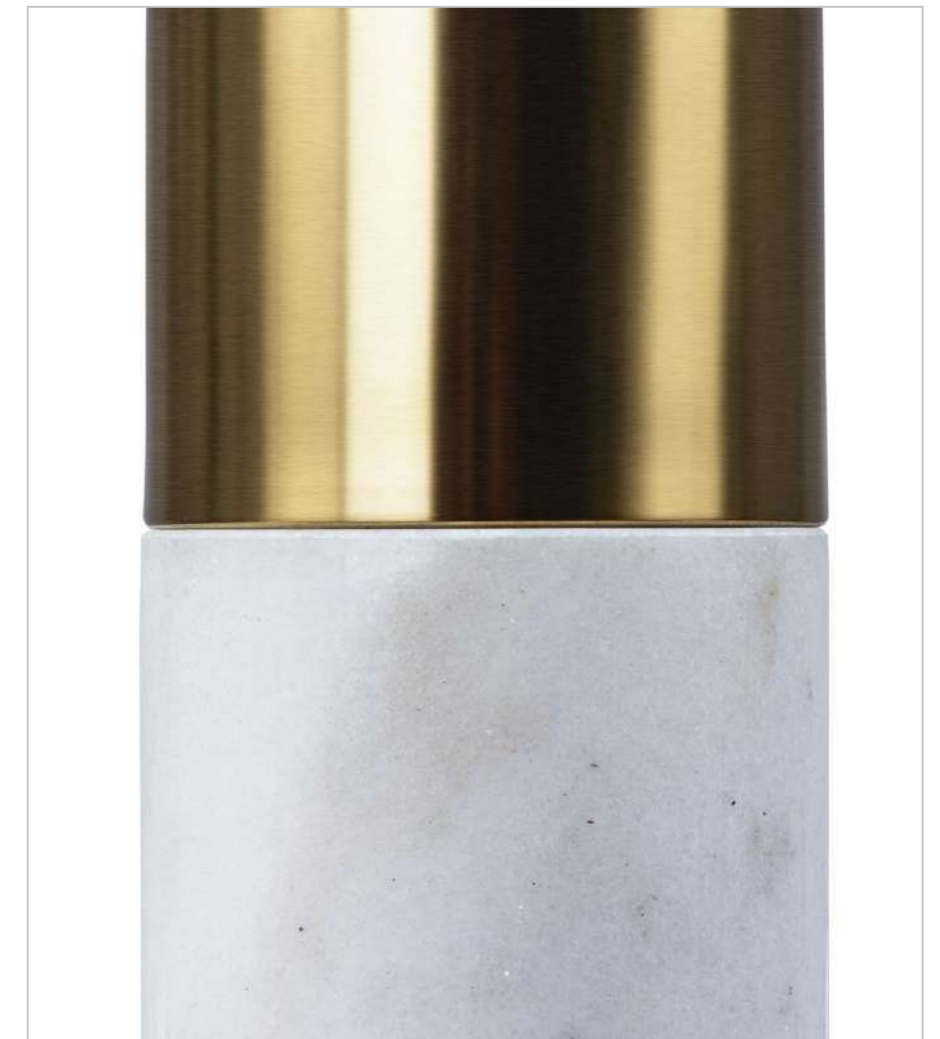



A4064LT-1BR

↑ 59 Ø 40
 ♀ 40W | E27
 ⚡ 130



Fixture material: ceramics
 Fixture colour: brown
 Shade material: fabric
 Shade colour: beige

Материал арматуры: керамика
 Цвет арматуры: коричневый
 Материал плафона: ткань
 Цвет плафона: бежевый



NEW

A5036LT-1BR

↑ 40 Ø 18
 ♀ 60W | E27
 ⚡ 150

JISHUI



Fixture material: metal plated, wood
 Fixture colour: brown
 Shade material: fabric
 Shade colour: beige

Материал арматуры: металл
 гальванизированный, дерево
 Цвет арматуры: коричневый
 Материал плафона: ткань
 Цвет плафона: бежевый



A4376LT-1BS

↑ 33 ↔ 13 ↙ 27
 ♀ 40W | E27
 ⚡ 130



Fixture material: poly resin
 Fixture colour: black silver
 Shade material: fabric
 Shade colour: gray

Материал арматуры: полимерный материал
 Цвет арматуры: черное серебро
 Материал плафона: ткань
 Цвет плафона: серый



A4015LT-1GO

↑ 52 ∅ 30
 ♀ 40W | E27
 ⚡ 130



A4015LT-1WH

↑ 52 ∅ 30
 ♀ 40W | E27
 ⚡ 130



A4015LT-1BK

↑ 52 ∅ 30
 ♀ 40W | E27
 ⚡ 130

Fixture material: poly resin
 Fixture colour: gold / white / black
 Shade material: fabric
 Shade colour: black / white

Материал арматуры: полимерный материал
 Цвет арматуры: золото / белый / черный
 Материал плафона: ткань
 Цвет плафона: черный / белый





A4014LT-1GO

↓ 51 ↔ 35 ↗ 16
 ♀ 40W | E27
 ⚡ 130

Fixture material: poly resin
 Fixture colour: gold
 Shade material: fabric
 Shade colour: black

Материал арматуры:
 полимерный материал
 Цвет арматуры: золото
 Материал плафона: ткань
 Цвет плафона: черный



A4013LT-1GO

↓ 64 ⌀ 36
 ♀ 40W | E27
 ⚡ 130

Fixture material: poly resin
 Fixture colour: gold
 Shade material: fabric
 Shade colour: black

Материал арматуры:
 полимерный материал
 Цвет арматуры: золото
 Материал плафона: ткань
 Цвет плафона: черный

GINAN





A4420LT-1GO

↑37 ↔ 17 ↗
 ♀ 40W | E14
 ☿ 130



A4420LT-1WH

↑37 ↔ 17 ↗
 ♀ 40W | E14
 ☿ 130

Fixture material: poly resin
 Fixture colour: gold / white
 Shade material: fabric
 Shade colour: black / white

Материал арматуры: полимерный материал
 Цвет арматуры: золото / белый
 Материал плафона: ткань
 Цвет плафона: черный / белый

GUSTAV



A4039LT-1GO

↑37 ↔ 18 ↗29
 ♀ 40W | E27
 ☿ 130



A4039LT-1CC

↑37 ↔ 18 ↗29
 ♀ 40W | E27
 ☿ 130

Fixture material: ceramics
 Fixture colour: gold / chrome
 Shade material: fabric
 Shade colour: black / white

Материал арматуры: керамика
 Цвет арматуры: золото / хром
 Материал плафона: ткань
 Цвет плафона: черный / белый





A4008LT-1WH

↑41 ↔ 20 ↗28
 ♀40W | E27
 Ψ130



A4008LT-1BK

↑41 ↔ 20 ↗28
 ♀40W | E27
 Ψ130

Fixture material: poly resin
 Fixture colour: white / black
 Shade material: fabric
 Shade colour: white / black

Материал арматуры: полимерный материал
 Цвет арматуры: белый / черный
 Материал плафона: ткань
 Цвет плафона: белый / черный

SCHEDAR



A1512LT-1WH

↑50 ↔ 20 ↗25
 ♀40W | E27
 Ψ130



A1512LT-1BK

↑50 ↔ 20 ↗25
 ♀40W | E27
 Ψ130



Fixture material: poly resin
 Fixture colour: black / white
 Shade material: fabric
 Shade colour: black / white

Материал арматуры: полимерный материал
 Цвет арматуры: черный / белый
 Материал плафона: ткань
 Цвет плафона: черный / белый





A6710SP-1WH

↓ 27 Ø 10
 ♀ 100W | E27
 ⚙ 70 ∇ 11



NEW

A1616LT-1WH

↓ 38 Ø 11
 ♀ 3W | LED, 250LM, 4000K,
 CRI/RA≥80



Fixture material: metal painted
 Fixture colour: white / black
 Shade material: pc
 Shade colour: white

NEW

A1616LT-1BK

↓ 38 Ø 11
 ♀ 3W | LED, 250LM, 4000K,
 CRI/RA≥80



Материал арматуры: металл крашенный
 Цвет арматуры: белый / черный
 Материал плафона: пластик
 Цвет плафона: белый

FUYUE



A6030LT-1WH

↓ 30 Ø 30
 ♀ 60W | E27
 ⚙ 150

Wall mounting
 available – возможна
 установка на стену



A6025LT-1WH

↓ 25 Ø 25
 ♀ 60W | E27
 ⚙ 150

Wall mounting
 available – возможна
 установка на стену



A6020LT-1WH

↓ 20 Ø 20
 ♀ 60W | E27
 ⚙ 150

Wall mounting
 available – возможна
 установка на стену



A6710LT-1WH

↓ 27 Ø 10
 ♀ 60W | E27
 ⚙ 150

Fixture material: plastic / metal plated
 Fixture colour: white
 Shade material: glass
 Shade colour: white

Материал арматуры: пластик / металл
 гальванизированный
 Цвет арматуры: белый
 Материал плафона: стекло
 Цвет плафона: белый



- Батарея 3000 мА/ч - 3000 mA/h battery
- Время работы - 4-6 часов - Working time - 4-6 hours
- Время зарядки - 2 часа - Charging time - 2 hours
- Диммируемый сенсорный выключатель Dimming sensor switch
- USB кабель 150 см в комплекте - 150 cm long USB cable included



Fixture material: metal plated
 Fixture colour: antique bronze
 Shade material: glass
 Shade colour: green / white /
 зеленый / белый

Материал арматуры: металл гальванизированный
 Цвет арматуры: античная бронза
 Материал плафона: стекло
 Цвет плафона: зеленый / белый



A2492LT-1AB

↑ 40 ↔ 27 ↘ 25
 ♀ 60W | E27
 ☿ 180



A2493LT-1AB

↑ 40 ↔ 27 ↘ 25
 ♀ 60W | E27
 ☿ 180



NEW

A5040LT-1AB

↑ 28 ∅ 23
 ♀ 7W | G4
 ☿ 180



NEW

A5041LT-1AB

↑ 28 ∅ 23
 ♀ 7W | G4
 ☿ 180





Fixture material: metal painted, metal plated
 Fixture colour: polished brass / black / white
 Shade material: metal plated / metal painted
 Shade colour: polished brass / black / white

Материал арматуры: металл крашенный, металл гальванизированный
 Цвет арматуры: полированная медь / черный / белый
 Материал плафона: металл гальванизированный / металл крашенный
 Цвет плафона: полированная медь / черный / белый



NEW
A5038LT-3WH

↑ 39 Ø 25
 ♀ 3X3W | G9
 ⚡ 150



NEW
A5038LT-3BK

↑ 39 Ø 25
 ♀ 3X3W | G9
 ⚡ 150



NEW
A5038LT-3PB

↑ 39 Ø 25
 ♀ 3X3W | G9
 ⚡ 150



NEW
A5056LT-1CC

↑ 32 Ø 32
 ♀ 60W | E27
 ⚡ 150



NEW
A5056LT-1GO

↑ 32 Ø 32
 ♀ 60W | E27
 ⚡ 150



NEW
A5056LT-1AB

↑ 32 Ø 32
 ♀ 60W | E27
 ⚡ 150

BRAVA



Fixture material: metal painted, metal plated
 Fixture colour: chrome / gold / antique bronze
 Shade material: glass
 Shade colour: white

Материал арматуры: металл крашенный, металл гальванизированный
 Цвет арматуры: хром / золото / античная бронза
 Материал плафона: стекло
 Цвет плафона: белый

SENIOR



A6068LT-1AB

↑ ↔ 17 ↗ 30
♀ 40W | E27
♂ 150



A6068LT-1SS

↑ 85 ↔ 17 ↗ 30
♀ 40W | E27
♂ 150



A6068LT-1BK

↑ 85 ↔ 17 ↗ 30
♀ 40W | E27
♂ 150



A6068LT-1WH

↑ 85 ↔ 17 ↗ 30
♀ 40W | E27
♂ 150



Desk clamp fastening —
крепление «струбцина»
для фиксации
на столешнице

Fixture material: metal plated, plastic /
metal painted, plastic
Fixture colour: antique bronze / black /
satin silver / white
Shade material: metal plated / metal
painted
Shade colour: antique bronze / black /
silver / white

Материал арматуры: металл
гальванизированный, пластик / металл
крашенный, пластик
Цвет арматуры: античная бронза /
черный / матовое серебро / белый
Материал плафона: металл
гальванизированный / металл крашенный
Цвет плафона: античная бронза / черный
/ серебро / белый



JUNIOR



A1330LT-1MG

↑ 61 ↔ 15 ↗ 35
♀ 40W | E27
♂ 150



A1330LT-1BK

↑ 61 ↔ 15 ↗ 35
♀ 40W | E27
♂ 150



A1330LT-1AB

↑ 61 ↔ 15 ↗ 35
♀ 40W | E27
♂ 150



A1330LT-1CC

↑ 61 ↔ 15 ↗ 35
♀ 40W | E27
♂ 150



A1330LT-1WH

↑ 61 ↔ 15 ↗ 35
♀ 40W | E27
♂ 150



Fixture material: metal plated, plastic / metal
painted, plastic
Fixture colour: antique bronze / black / chrome /
magenta / white
Shade material: metal plated / metal painted
Shade colour: antique bronze / black / chrome /
magenta / white

Материал арматуры: металл гальванизированный,
пластик / металл крашенный, пластик
Цвет арматуры: античная бронза / черный / хром /
сиреневый / белый
Материал плафона: металл / металл крашенный
Цвет плафона: античная бронза / черный / хром /
сиреневый / белый



EDWARD



NEW
A5126LT-1WH

↑38 ↔ 18 ↗11
♀ 7W | LED, 220LM,
4000K, CRI/RA≥80
ϕ100



Fixture material: metal painted, plastic
Fixture colour: black
Shade material: plastic
Shade colour: white



NEW
A5126LT-1BK

↑38 ↔ 18 ↗11
♀ 7W | LED, 220LM,
4000K, CRI/RA≥80
ϕ100



Материал арматуры: металл крашенный
Цвет арматуры: черный
Материал плафона: пластик
Цвет плафона: белый



NEW
A5122LT-1WH

↑41 ↔ 11 ↗18
♀ 5W | LED, 300LM,
3000,3500,4200,5000,6000K,
CRI/RA≥80
ϕ150



Fixture material: metal
Fixture colour: white / black
Shade material: plastic
Shade colour: white



NEW
A5122LT-1BK

↑41 ↔ 11 ↗18
♀ 5W | LED, 300LM,
3000,3500,4200,5000,6000K,
CRI/RA≥80
ϕ150



Материал арматуры: металл
Цвет арматуры: белый / черный
Материал плафона: пластик
Цвет плафона: белый

- nightlight - ночник
- color temperature 3000-6000K – цветовая температура 3000-6000K
- 5W wireless charging, USB-port and adapter included – беспроводная зарядка 5W, USB-порт и адаптер в комплекте
- 60 minutes timer – таймер 60 минут

COMFORT ZONE

CONFERENCE



A1106LT-1WH

↑40 ↔ 6 ↗40
♀ 5W | LED, 250LM,
4000K, CRI/RA≥80
ϕ150



Fixture material: plastic, silicon, aluminum
Fixture colour: black / white
Shade material: plastic, silicon, aluminum
Shade colour: black / white



A1106LT-1BK

↑40 ↔ 6 ↗40
♀ 5W | LED, 250LM,
4000K, CRI/RA≥80
ϕ150



Материал арматуры: пластик, силикон, алюминий
Цвет арматуры: черный / белый
Материал плафона: пластик, силикон, алюминий
Цвет плафона: черный / белый

WILLIAM



EDWARD | CONFERENCE | WILLIAM



A5123LT-1WH

↑33 ↔ 17 ↗12
 ♀9W | LED, 450LM,
 3000-6500K, CRI/RA≥80



A5123LT-1BK

↑33 ↔ 17 ↗12
 ♀9W | LED, 450LM,
 3000-6500K, CRI/RA≥80



Fixture material: plastic
 Fixture colour: black / white
 Shade material: plastic
 Shade colour: white

Материал арматуры: пластик
 Цвет арматуры: черный / белый
 Материал плафона: пластик
 Цвет плафона: белый



NEW

A5124LT-1WH

↑34 ↔ 17 ↗12
 ♀5W | LED, 200LM,
 2700-5000K, CRI/RA≥80



NEW

A5124LT-1BK

↑34 ↔ 17 ↗12
 ♀5W | LED, 200LM,
 2700-5000K, CRI/RA≥80



- USB port and adapter included
- Operates either from the network or from the computer

- USB порт и адаптор в комплекте
- может работать как от сети так и от компьютера



Fixture material: plastic
 Fixture colour: white / black
 Shade material: plastic
 Shade colour: white

Материал арматуры: пластик
 Цвет арматуры: белый / черный
 Материал плафона: пластик
 Цвет плафона: белый

CAMBRIDGE





A2054LT-1BK

↓ 54 ↔ 18 ↗ 47
 ⌀ 60W | E27
 ⚡ 180



A2054LT-1WH

↓ 54 ↔ 18 ↗ 47
 ⌀ 60W | E27
 ⚡ 180



A2054LT-1AB

↓ 54 ↔ 18 ↗ 47
 ⌀ 60W | E27
 ⚡ 180



A2054AP-1BK

↓ 22 ↔ 15 ↗ 40
 ⌀ 60W | E27



A2054AP-1WH

↓ 11 ↔ 15 ↗ 40
 ⌀ 60W | E27



A2054AP-1AB

↓ 22 ↔ 15 ↗ 40
 ⌀ 60W | E27



A2055AP-1WH

↓ 35 ↔ 15 ↗ 67
 ⌀ 60W | E27



A2055AP-1AB

↓ 35 ↔ 15 ↗ 67
 ⌀ 60W | E27



A2055AP-1BK

↓ 35 ↔ 15 ↗ 67
 ⌀ 60W | E27



Fixture material: metal painted, metal plated
 Fixture colour: antique bronze / black / white
 Shade material: metal plated / metal painted
 Shade colour: antique bronze / black / white

Материал арматуры: металл крашенный, металл гальванизированный
 Цвет арматуры: античная бронза / черный / белый
 Материал плафона: металл гальванизированный / металл крашенный
 Цвет плафона: античная бронза / черный / белый



A2054SP-1BK

↓ 16 ∅ 14
 ♀ 60W | E27
 ⚙ 100 ∇ 10



A2054SP-1WH

↓ 16 ∅ 14
 ♀ 60W | E27
 ⚙ 100 ∇ 10



A2054SP-1AB

↓ 16 ∅ 14
 ♀ 60W | E27
 ⚙ 100 ∇ 10



A2055SP-1BK

↓ 23 ∅ 26
 ♀ 60W | E27
 ⚙ 100 ∇ 10



A2055SP-1WH

↓ 23 ∅ 26
 ♀ 60W | E27
 ⚙ 100 ∇ 10



A2055SP-1AB

↓ 23 ∅ 26
 ♀ 60W | E27
 ⚙ 100 ∇ 10



A2054PN-1BK

↓ 144 ↔ 26 ↗ 88
 ♀ 60W | E27
 ∇ 180



A2054PN-1AB

↓ 144 ↔ 26 ↗ 88
 ♀ 60W | E27
 ∇ 180



A2054PN-1WH

↓ 144 ↔ 26 ↗ 88
 ♀ 60W | E27
 ∇ 180



Fixture material: metal painted, metal plated
 Fixture colour: antique bronze / black / white
 Shade material: metal plated / metal painted
 Shade colour: antique bronze / black / white

Материал арматуры: металл крашенный, металл гальванизированный
 Цвет арматуры: античная бронза / черный / белый
 Материал плафона: металл гальванизированный / металл крашенный
 Цвет плафона: античная бронза / черный / белый





NEW
A5039AP-1AB

↑ 32 ↔ 16 ↗ 23
♀ 60W | E27



NEW
A5039TL-1AB

↑ 42 Ø 22
♀ 60W | E27
☿ 150



NEW
A5039PN-1AB

↑ 156 Ø 30
♀ 60W | E27
☿ 180

Fixture material: metal plated
Fixture colour: chrome / antique bronze
Shade material: fabric
Shade colour: white / beige

Материал арматуры: металл
гальванизированный
Цвет арматуры: хром / античная бронза
Материал плафона: ткань
Цвет плафона: белый / бежевый

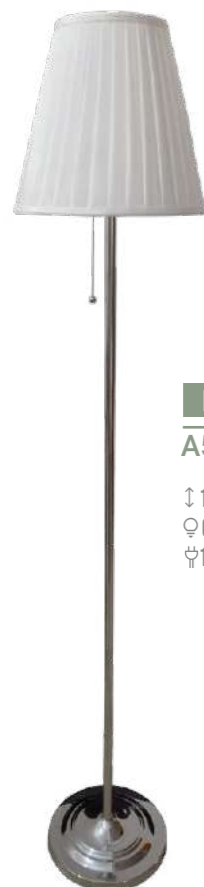

NEW
A5039PN-1CC

↑ 156 Ø 30
♀ 60W | E27
☿ 180



NEW
A5039AP-1CC

↑ 32 ↔ 16 ↗ 23
♀ 60W | E27



NEW
A5039TL-1CC

↑ 42 Ø 22
♀ 60W | E27
☿ 150





A2581AP-2CC

↑ 32 ↔ 20 ↗ 26
 ♀ 60W/3W | E27/LED



USB charge socket
 5V 2A – розетка
 USB 5V 2A



A2581AP-2AB

↑ 32 ↔ 20 ↗ 26
 ♀ 60W/3W | E27/LED



USB charge socket
 5V 2A – розетка
 USB 5V 2A



A2581AP-1AB

↑ 29 ↔ 18 ↗ 23
 ♀ 60W | E27



A2581LT-1AB

↑ 45 ∅ 25
 ♀ 60W | E27
 ⚓ 120



A2581PN-1AB

↑ 150 ∅ 38
 ♀ 60W | E27
 ⚓ 150

A2581PN-2AB

↑ 150 ∅ 38
 ♀ 60W/3W | E27/LED
 ⚓ 150



A2581AP-1CC

↑ 29 ↔ 18 ↗ 23
 ♀ 60W | E27



A2581LT-1CC

↑ 45 ∅ 25
 ♀ 60W | E27
 ⚓ 120



A2581PN-1CC

↑ 150 ∅ 38
 ♀ 60W | E27
 ⚓ 150

A2581PN-2CC

↑ 150 ∅ 38
 ♀ 60W/3W | E27/LED
 ⚓ 150



Fixture material: metal plated
 Fixture colour: chrome / antique bronze
 Shade material: fabric
 Shade colour: white

Материал арматуры: металл гальванизированный
 Цвет арматуры: хром / античная бронза
 Материал плафона: ткань
 Цвет плафона: белый





A5031AP-1PB

↓ 24 ↔ 18 ↗ 25
 ⌀ 60W | E27



A5031AP-1SS

↓ 24 ↔ 18 ↗ 25
 ⌀ 60W | E27

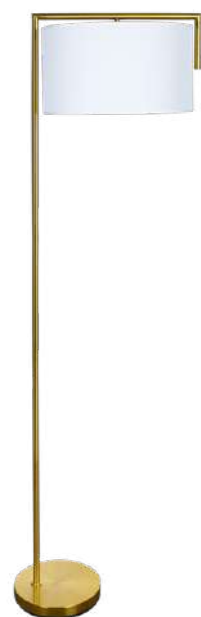

A5031PN-1PB

↓ 165 ↔ 40 ↗ 51
 ⌀ 60W | E27
 ⌀ 180

Fixture material: metal plated
 Fixture colour: satin silver / polished brass
 Shade material: fabric
 Shade colour: white



A5031PN-1SS

↓ 165 ↔ 40 ↗ 51
 ⌀ 60W | E27
 ⌀ 180

Материал арматуры: металл гальванизированный
 Цвет арматуры: матовое серебро / полированная медь
 Материал плафона: ткань
 Цвет плафона: белый



A5031LT-1PB

↓ 51 ↔ 25 ↗ 32
 ⌀ 60W | E27
 ⌀ 180



A5031LT-1SS

↓ 51 ↔ 25 ↗ 32
 ⌀ 60W | E27
 ⌀ 180



NEW
 A5037LT-2CC

↓ 38 ↔ 25 ↗ 15
 ⌀ 2X40W | E14
 ⌀ 150



NEW
 A5037AP-1CC

↓ 54 ↔ 28 ↗ 16
 ⌀ 60W | E27

NEW
 A5037PN-2CC

↓ 177 ↔ 40 ↗ 18
 ⌀ 2X60W | E27
 ⌀ 180

Fixture material: metal plated
 Fixture colour: chrome
 Shade material: fabric
 Shade colour: white

Материал арматуры: металл гальванизированный
 Цвет арматуры: хром
 Материал плафона: ткань
 Цвет плафона: белый

JULIETTA





A5029PN-1SS

↓ 160 ∅ 40
 ♀ 60W | E27
 ⚗ 150

Fixture material: metal plated, wood
 Fixture colour: satin silver
 Shade material: fabric
 Shade colour: white

Материал арматуры: металл гальванизированный, дерево
 Цвет арматуры: матовое серебро
 Материал плафона: ткань
 Цвет плафона: белый



A2589AP-1SS

↓ 31 ↔ 15 ↗ 21
 ♀ 60W | E27



A2589LT-1SS

↓ 45 ∅ 20
 ♀ 60W | E27
 ⚗ 120

Fixture material: metal painted, metal plated
 Fixture colour: satin silver
 Shade material: fabric
 Shade colour: white

Материал арматуры: металл крашенный, металл гальванизированный
 Цвет арматуры: матовое серебро
 Материал плафона: ткань
 Цвет плафона: белый



A2589PN-1SS

↓ 150 ∅ 32
 ♀ 60W | E27
 ⚗ 150

RODOS



A5029AP-1SS

↓ 37 ↔ 20 ↗ 25
 ♀ 60W | E27



A5029LT-1SS

↓ 48 ∅ 30
 ♀ 60W | E27
 ⚗ 150





A1021SP-5SS

↓ 30 Ø 46
 ♀ 5X40W | E27
 ⚙ 90 ∇ 10



A1021SP-3SS

↓ 28 Ø 39
 ♀ 3X40W | E27
 ⚙ 90 ∇ 10



A1021PN-1SS

↓ 155 Ø 39
 ♀ 60W | E27
 ∇ 180



A1021LT-1SS

↓ 56 Ø 29
 ♀ 40W | E27
 ∇ 180



A1021AP-1SS

↓ 23 ↔ 26 ↗ 16
 ♀ 40W | E27

Fixture material: metal plated
 Fixture colour: satin silver
 Shade material: fabric
 Shade colour: gray

Материал арматуры: металл
 гальванизированный
 Цвет арматуры: матовое серебро
 Материал плафона: ткань
 Цвет плафона: серый

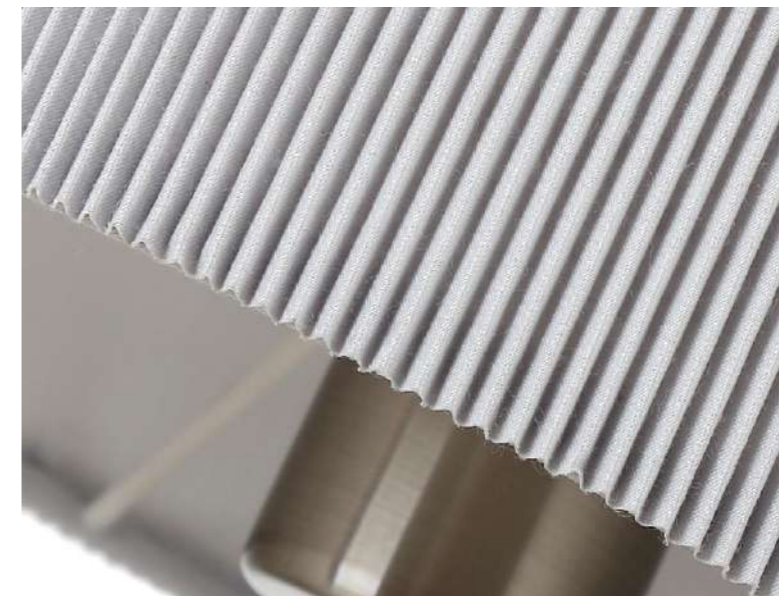



A5024AP-1PB

↓ 33 ↔ 18 ↗ 25
 ♀ 60W | E27



A5024LT-1PB

↓ 49 ↔ 20 ↗ 35
 ♀ 60W | E27
 ⚡ 180



A5024PN-1PB

↓ 155 ↔ 35 ↗ 45
 ♀ 60W | E27
 ⚡ 180



Fixture material: metal plated, marble
 Fixture colour: polished brass
 Shade material: fabric
 Shade colour: white

Материал арматуры: металл гальванизированный, мрамор
 Цвет арматуры: полированная медь
 Материал плафона: ткань
 Цвет плафона: белый



A4031AP-1PB

↓ 41 ↔ 20 ↗ 24
 ♀ 60W | E27



A4031LT-1PB

↓ 58 ∅ 30
 ♀ 60W | E27
 ⚡ 180



A4031PN-1PB

↓ 158 ∅ 38
 ♀ 60W | E27
 ⚡ 180

Fixture material: metal plated
 Fixture colour: polished brass
 Shade material: fabric
 Shade colour: white

Материал арматуры: металл гальванизированный
 Цвет арматуры: полированная медь
 Материал плафона: ткань
 Цвет плафона: белый

PROXIMA

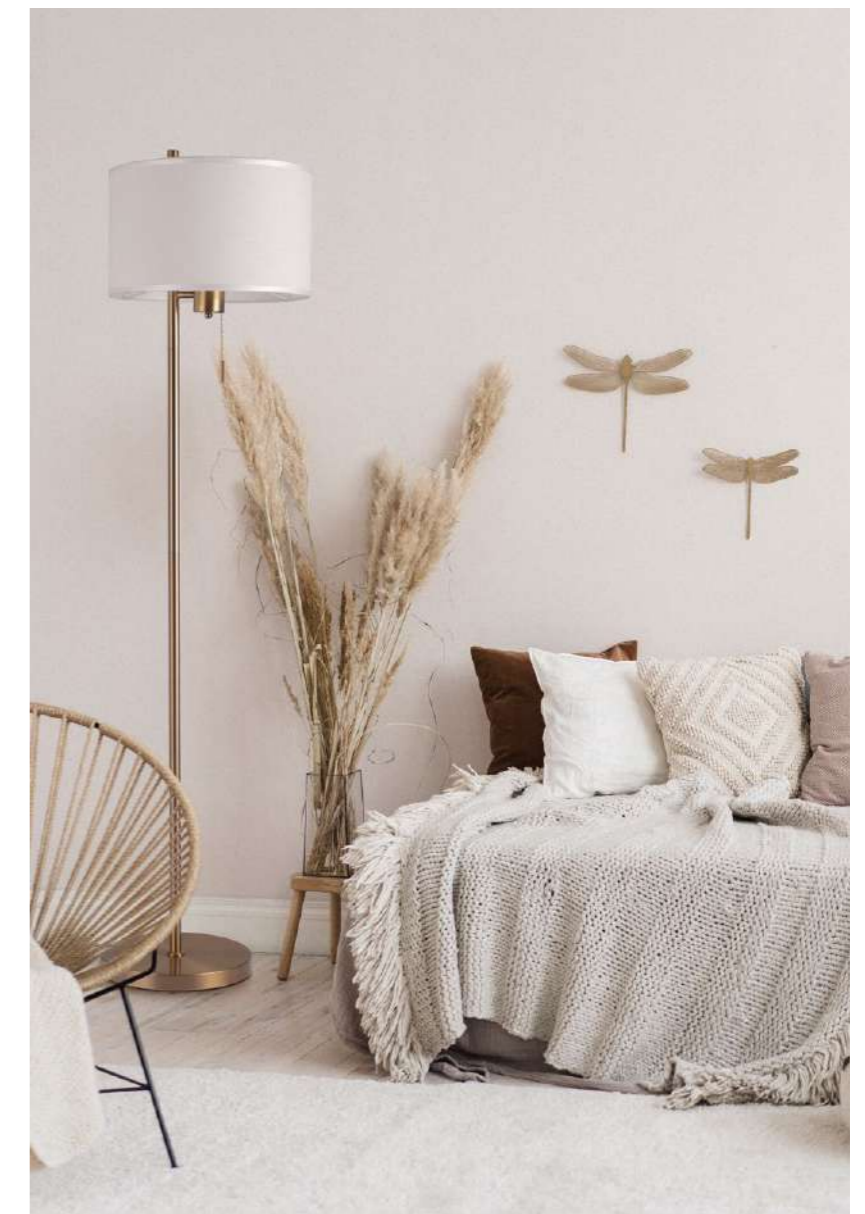



A9246AP-2SS

↑ 53 ↔ 18 ↗ 22
 ♀ 40W/3W | E27/LED



A9249AP-2AB

↑ 50 ↔ 18 ↗ 23
 ♀ 40W/3W | E27/LED



A9246AP-2AB

↑ 53 ↔ 18 ↗ 22
 ♀ 40W/3W | E27/LED



Fixture material: metal plated
 Fixture colour: antique bronze / satin silver
 Shade material: fabric
 Shade colour: white / black

Материал арматуры: металл
 гальванизированный
 Цвет арматуры: античная бронза /
 матовое серебро
 Материал плафона: ткань
 Цвет плафона: белый / черный

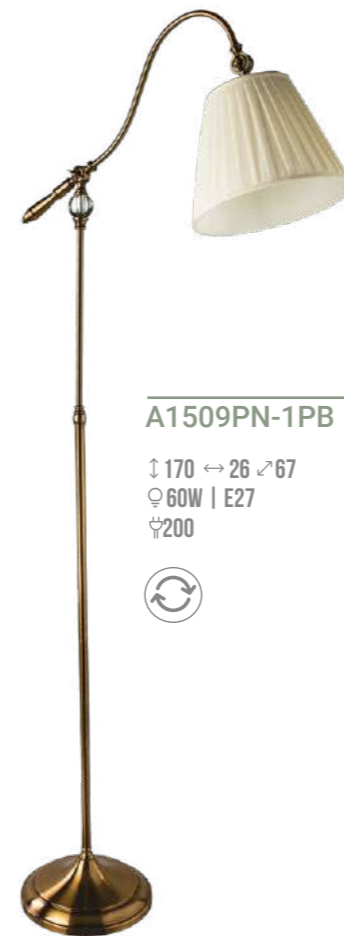

A1509PN-1PB

↑ 170 ↔ 26 ↗ 67
 ♀ 60W | E27
 ⌀ 200



A1509LT-1PB

↑ 64 ↔ 22 ↗ 51
 ♀ 60W | E27
 ⌀ 180



A1509AP-1PB

↑ 36 ↔ 18 ↗ 32
 ♀ 40W | E14



SEVILLE

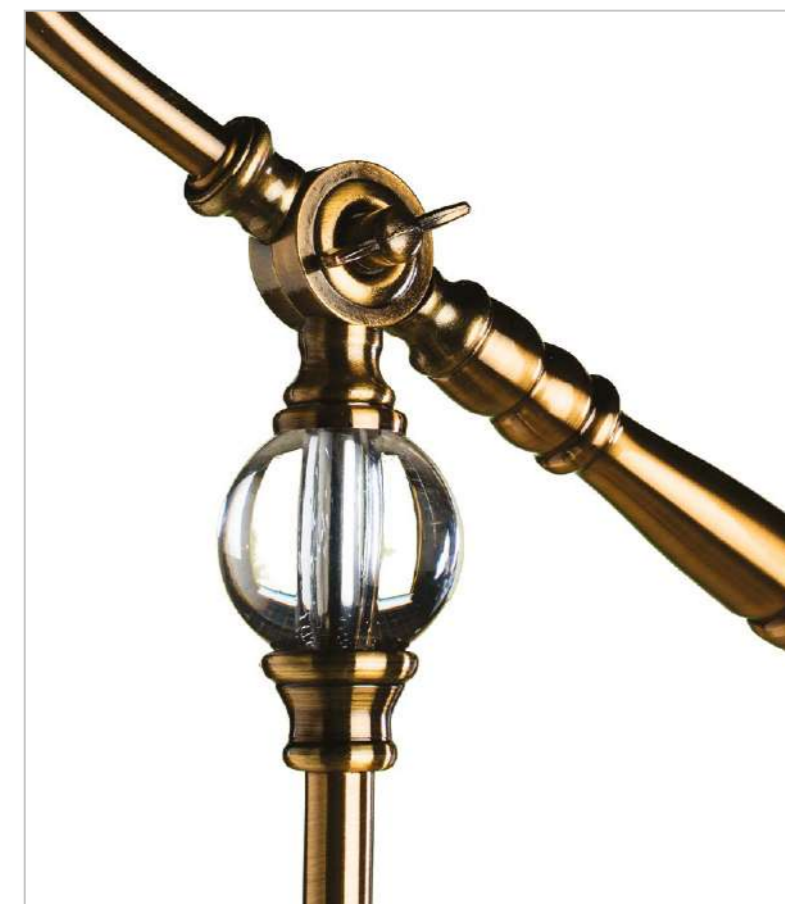

Fixture material: metal plated / metal
 plated, glass
 Fixture colour: polished brass
 Shade material: fabric
 Shade colour: beige

Материал арматуры: металл
 гальванизированный / металл
 гальванизированный, стекло
 Цвет арматуры: полированная медь
 Материал плафона: ткань
 Цвет плафона: бежевый



A4048PN-1CC

↑ 165 Ø38
 ♂ 40W/13W | E27/LED
 ☿ 200



Fixture material: metal plated, glass
 Fixture colour: chrome
 Shade material: fabric
 Shade colour: white

Материал арматуры: металл
 гальванизированный, стекло
 Цвет арматуры: хром
 Материал плафона: ткань
 Цвет плафона: белый



A4023PN-1CC

↑ 152 Ø41
 ♂ 40W | E27
 ☿ 200

Fixture material: metal plated, crystal
 Fixture colour: chrome
 Shade material: fabric
 Shade colour: white

Материал арматуры: металл
 гальванизированный, хрусталь
 Цвет арматуры: хром
 Материал плафона: ткань
 Цвет плафона: белый





A4054PN-1PB

↓ 161 ↔ 32 ↗ 85
 ♀ 60W | E27
 ☿ 180



Fixture material: metal plated
 Fixture colour: polished brass
 Shade material: fabric
 Shade colour: white

Материал арматуры: металл
 гальванизированный
 Цвет арматуры:
 полированная медь
 Материал плафона: ткань
 Цвет плафона: белый



A4060PN-1CC

↓ 195 ↔ 32 ↗ 92
 ♀ 60W | E27
 ☿ 180



A4060PN-1PB

↓ 195 ↔ 32 ↗ 92
 ♀ 60W | E27
 ☿ 180



A5822PN-1SS

↓ 170 ↔ 30 ↗ 100
 ♀ 60W | E27
 ☿ 180



A5822PN-1PB

↓ 170 ↔ 30 ↗ 100
 ♀ 60W | E27
 ☿ 180



PAOLO

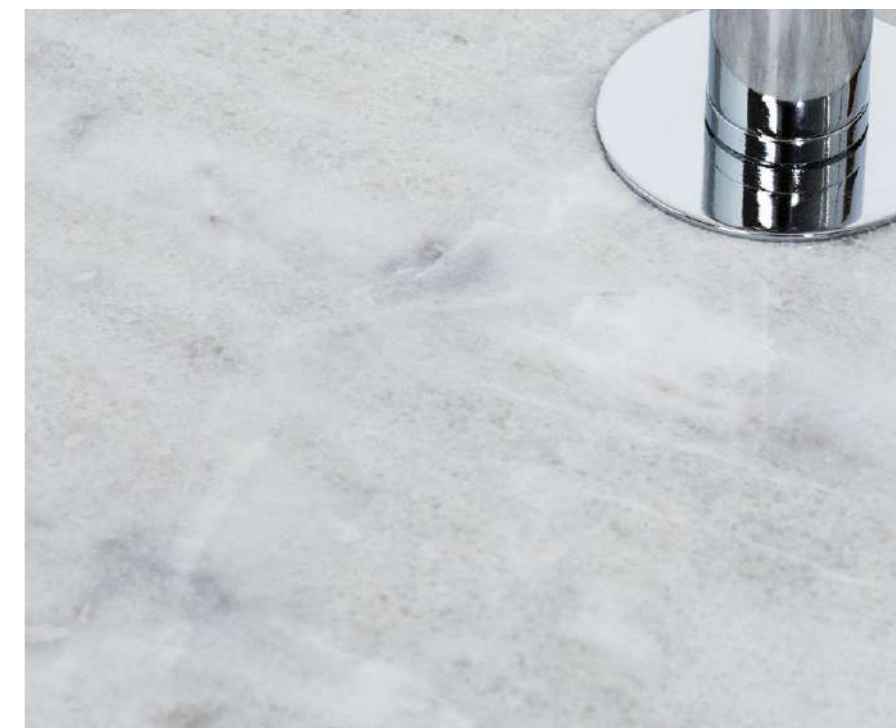

Fixture material: metal plated, marble
 Fixture colour: satin silver / polished
 brass / chrome
 Shade material: plastic / fabric
 Shade colour: white / gray / beige

Материал арматуры: металл
 гальванизированный, мрамор
 Цвет арматуры: матовое серебро /
 полированная медь / хром
 Материал плафона: пластик / ткань
 Цвет плафона: белый / серый /
 бежевый



Fixture material: metal painted
 Fixture colour: black / white
 Shade material: metal painted
 Shade colour: black / white

Материал арматуры: металл крашенный
 Цвет арматуры: черный / белый
 Материал плафона: металл крашенный
 Цвет плафона: черный / белый



A2487PN-1BK
 ↓ 180-206 ↔ 40 ↗ 65-90
 ♀ 60W | E27
 ☿ 180



A2487PN-1WH
 ↓ 180-206 ↔ 40 ↗ 65-90
 ♀ 60W | E27
 ☿ 180



A4329PN-2AB
 ↓ 181 ∅25
 ♀ 230W/33W
 R7S-118MM/G9
 ☿ 180



A4329PN-2CC
 ↓ 181 ∅25
 ♀ 230W/33W |
 R7S-118MM/G9
 ☿ 180



Fixture material: metal plated / metal painted,
 metal plated
 Fixture colour: antique bronze / satin silver /
 chrome / black
 Shade material: plastic / glass
 Shade colour: white

Материал арматуры: металл
 гальванизированный / металл крашенный,
 металл гальванизированный
 Цвет арматуры: античная бронза /
 матовое серебро / хром / черный
 Материал плафона: пластик / стекло
 Цвет плафона: белый



A9569PN-2AB
 ↓ 177 ∅28
 ♀ 60W/25W | E27/E14
 ☿ 180



A9569PN-2SS
 ↓ 177 ∅28
 ♀ 60W/25W | E27/E14
 ☿ 180



A9569PN-2BK
 ↓ 177 ∅28
 ♀ 60W/25W | E27/E14
 ☿ 180



DUETTO





A2070PN-1BK

↓ 163 ∅38
 ♀ 60W | E27
 ⚡ 240



A4053PN-1BK

↓ 171 ↔ 28 ↗ 35
 ♀ 60W | E27
 ⚡ 180



A2102PN-1WH

↓ 159 ∅38
 ♀ 60W | E27
 ⚡ 190



A2102LT-1WH

↓ 44 ∅23
 ♀ 40W | E14
 ⚡ 170

CONNOR



A4055PN-1BK

↓ 170 ↔ 30 ↗ 44
 ♀ 60W | E27
 ⚡ 180



A4056PN-1WH

↓ 168 ∅32
 ♀ 60W | E27
 ⚡ 180

two USB-charge socket 5V 1A —
 две розетки USB 5V 1A



Fixture material: metal painted, wood
 Fixture colour: black / white
 Shade material: fabric
 Shade colour: black / gray / white
 Материал арматуры: металл крашенный, дерево
 Цвет арматуры: черный / белый
 Материал плафона: ткань
 Цвет плафона: черный / серый / белый



Fixture material: metal painted
 Fixture colour: white / black
 Shade material: fabric
 Shade colour: white

Материал арматуры: металл крашенный
 Цвет арматуры: белый / черный
 Материал плафона: ткань
 Цвет плафона: белый





Fixture material: aluminum, PC, silicone Материал арматуры: алюминий, пластик, силикон
 Fixture colour: black / white Цвет арматуры: черный / белый



A7603AP-1BK

↑41 ↔ 7 ↙4
 ∅ 3W | LED, 180LM, 4000K, CRI/RA≥70



A7603AP-1WH

↑41 ↔ 7 ↙4
 ∅ 3W | LED, 180LM, 4000K, CRI/RA≥70



CERCARE



A4107AP-1BK

↑6 ↔ 6 ↙40
 ∅ 7W | LED, 600LM,
 4000K, CRI/RA≥80



A4107AP-1WH

↑6 ↔ 6 ↙40
 ∅ 7W | LED, 600LM,
 4000K, CRI/RA≥80



Fixture material: aluminum, silicone
 Fixture colour: black / white
 Shade material: aluminum
 Shade colour: black / white

Материал арматуры: алюминий,
 силикон
 Цвет арматуры: черный / белый
 Материал плафона: алюминий
 Цвет плафона: черный / белый

SCORCIO



A7005AP-1SS

↑44 ↔ 3 ↙5
 ∅ 3W | LED COB, 240LM,
 3000K, CRI/RA≥70



Fixture material: aluminum
 Fixture colour: satin silver
 Shade material: aluminum
 Shade colour: satin silver

Материал арматуры: алюминий
 Цвет арматуры: матовое серебро
 Материал плафона: алюминий
 Цвет плафона: матовое серебро



A1408AP-1AB

↑20 ↔ 13 ↗33
 ♀40W | E14



A1408AP-1BK

↑20 ↔ 13 ↗33
 ♀40W | E14



A1408AP-1WH

↑20 ↔ 13 ↗33
 ♀40W | E14



Fixture material: metal plated / metal painted, metal plated
 Fixture colour: antique bronze / black / white
 Shade material: metal plated / metal painted
 Shade colour: antique bronze / black / white

Материал арматуры: металл гальванизированный / металл крашенный, металл гальванизированный
 Цвет арматуры: античная бронза / черный / белый
 Материал плафона: металл / металл крашенный
 Цвет плафона: античная бронза / черный / белый



Fixture material: metal plated / metal painted
 Fixture colour: antique bronze / black chrome / brown / satin silver / white gold
 Shade material: glass
 Shade colour: white

Материал арматуры: металл гальванизированный / металл крашенный
 Цвет арматуры: античная бронза / черный хром / коричневый / матовое серебро / бело-золотой / белый
 Материал плафона: стекло
 Цвет плафона: белый

LETTURA





A3116AP-1AB

↑ 54 ↔ 7 ↗ 8
 ♀ 40W | E14
 ⌀ 150 ∇ 8



A3116AP-1BK

↑ 54 ↔ 7 ↗ 8
 ♀ 40W | E14
 ⌀ 150 ∇ 8



A3116AP-1WH

↑ 54 ↔ 7 ↗ 8
 ♀ 40W | E14
 ⌀ 150 ∇ 8



A3116AP-1SS

↑ 54 ↔ 7 ↗ 8
 ♀ 40W | E14
 ⌀ 150 ∇ 8



Fixture material: metal plated / metal plated, painted / aluminum
 Fixture colour: satin silver / black / white / antique bronze
 Shade material: glass
 Shade colour: white

Материал арматуры: металл гальванизированный / металл гальванизированный, крашенный / алюминий
 Цвет арматуры: матовое серебро / черный / белый / античная бронза
 Материал плафона: стекло
 Цвет плафона: белый



A3117PL-2BK

↑ 20 ↔ 9 ↗ 26
 ♀ 2X40W | E14
 ∇ 8



A3117AP-1BK

↑ 13 ↔ 9 ↗ 17
 ♀ 40W | E14
 ∇ 8



A3117PL-2WH

↑ 20 ↔ 9 ↗ 26
 ♀ 2X40W | E14
 ∇ 8



A3117AP-1WH

↑ 13 ↔ 9 ↗ 17
 ♀ 40W | E14
 ∇ 8



A3117PL-4BK

↑ 20 ↔ 9 ↗ 73
 ♀ 4X40W | E14
 ∇ 8



A3117PL-4WH

↑ 20 ↔ 9 ↗ 73
 ♀ 4X40W | E14
 ∇ 8



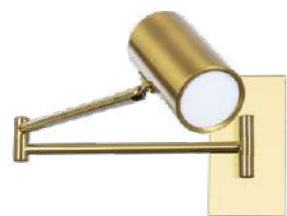
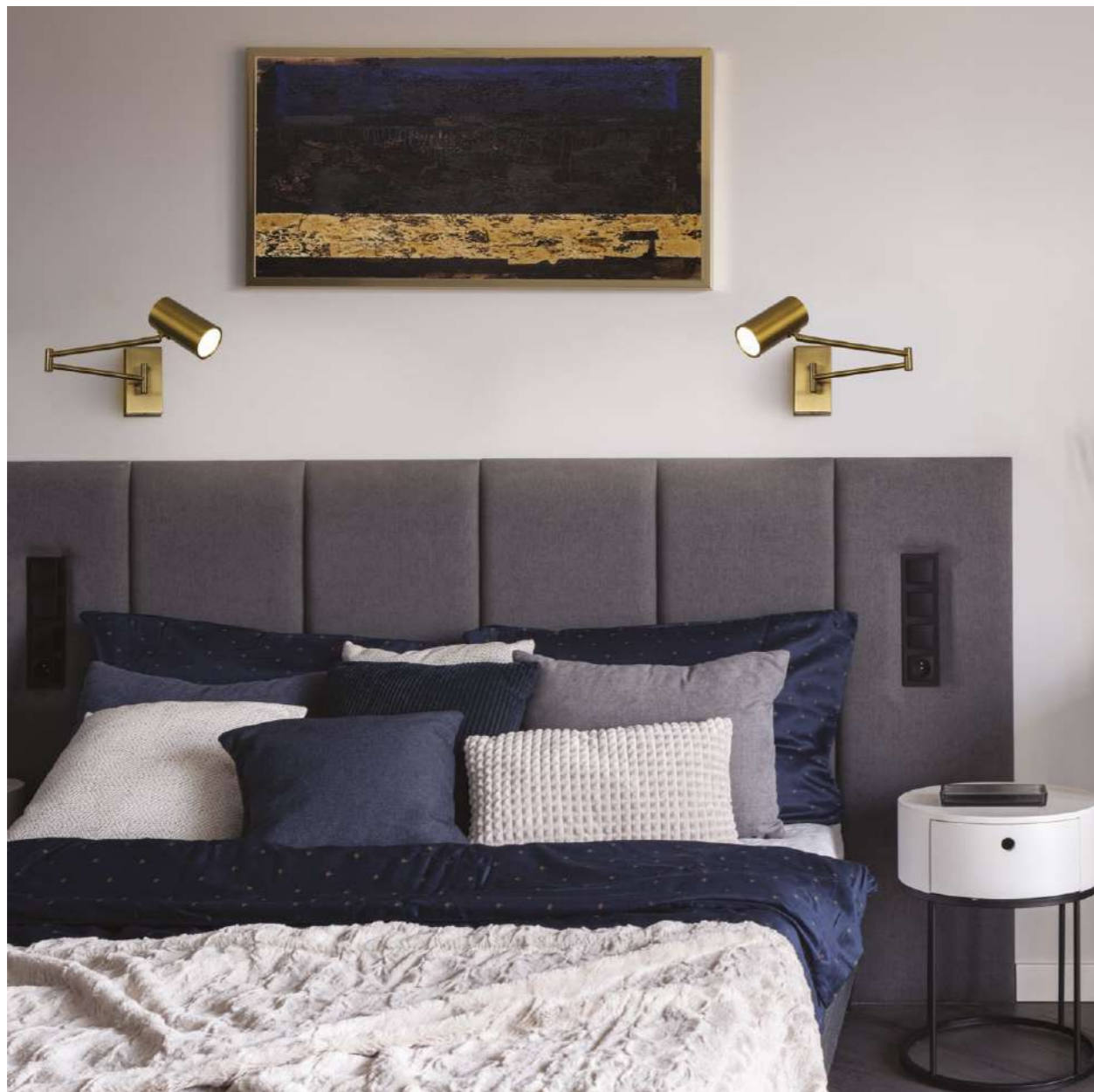

A2490AP-1PB

↑ 14 ↔ 51 ↗ 6
 ∅ 7W | LED, 350LM,
 4000K, CRI/RA≥80



Fixture material: metal plated / metal painted
 Fixture colour: polished brass / black
 Shade material: plastic / acrylic
 Shade colour: white

Материал арматуры: металл
 гальванизированный / металл крашенный
 Цвет арматуры: полированная медь /
 черный
 Материал плафона: пластик / акрил
 Цвет плафона: белый



NEW

A2490AP-1BK

↑ 14 ↔ 51 ↗ 6
 ∅ 6W | LED, 300LM,
 4000K, CRI/RA≥80



NEW

A2423AP-5CC

↑ 15 ↔ 5 ↗ 45
 ∅ 5W | LED, 250LM,
 4000K, CRI/RA≥80
 ∇ 5



NEW

A2423AP-5PB

↑ 15 ↔ 5 ↗ 45
 ∅ 5W | LED, 250LM,
 4000K, CRI/RA≥80
 ∇ 5



SULAFAT



Fixture material: metal painted
 Fixture colour: black
 Shade material: plastic
 Shade colour: clear

Материал арматуры: металл
 крашенный
 Цвет арматуры: черный
 Материал плафона: пластик
 Цвет плафона: прозрачный

MISSILE



NEW

A2039AP-10BK

↑ 60 ↔ 11 ↗ 2
 ♀ 10W | LED, 500LM,
 4000K, CRI/RA≥80



NEW

A2039AP-13BK

↑ 80 ↔ 15 ↗ 2
 ♀ 13W | LED, 650LM,
 4000K, CRI/RA≥80



Fixture material: metal painted
 Fixture colour: black
 Shade material: acrylic
 Shade colour: white

Материал арматуры: металл крашенный
 Цвет арматуры: черный
 Материал плафона: акрил
 Цвет плафона: белый



A2142AP-10BK

↑ 72 ↔ 15 ↗ 15
 ♀ 10W | LED, 500LM,
 4000K, CRI/RA≥80



Dimmer –
 Диммер



A2142AP-10PB

↑ 72 ↔ 15 ↗ 15
 ♀ 10W | LED, 500LM,
 4000K, CRI/RA≥80



Dimmer –
 Диммер

Fixture material: metal painted / metal plated
 Fixture colour: black / polished brass
 Shade material: plastic
 Shade colour: white

Материал арматуры: металл крашенный /
 металл гальванизированный
 Цвет арматуры: черный / полированная медь
 Материал плафона: пластик
 Цвет плафона: белый



MIRACH

COMFORT ZONE

MISSILE | MIRACH



Fixture material: metal painted / metal plated
 Fixture colour: black / polished brass
 Shade colour: white

Материал арматуры: металл крашенный / металл гальванизированный
 Цвет арматуры: черный / полированная медь
 Цвет плафона: белый



A2025AP-1PB

↓ 84 ↔ 5 ↗ 15
 ♀ 16W | LED, 800LM,
 4000K, CRI/RA≥80



A2025AP-1BK

↓ 84 ↔ 5 ↗ 15
 ♀ 16W | LED, 800LM,
 4000K, CRI/RA≥80



NEW

A2026AP-1BK

↓ 8 ↔ 6 ↗ 61
 ♀ 16W | LED, 1170LM, 4000K,
 CRI/RA≥80



Fixture material: metal painted
 Fixture colour: black
 Shade material: acrylic
 Shade colour: white

Материал арматуры: металл крашенный
 Цвет арматуры: черный
 Материал плафона: акрил
 Цвет плафона: белый



SARGAS



A2027AP-1BK

↓ 63 ↔ 6 ↗ 10
 ♀ 8W | LED, 645LM,
 4000K, CRI/RA≥80



A2027AP-1GO

↓ 63 ↔ 6 ↗ 10
 ♀ 8W | LED, 645LM,
 4000K, CRI/RA≥80



A2027AP-1PB

↓ 63 ↔ 6 ↗ 10
 ♀ 8W | LED, 645LM,
 4000K, CRI/RA≥80



A2027AP-1CC

↓ 63 ↔ 6 ↗ 10
 ♀ 8W | LED, 645LM,
 4000K, CRI/RA≥80



Fixture material: metal plated / metal painted
 Fixture colour: polished brass / chrome / black / gold
 Shade material: acrylic
 Shade colour: white

Материал арматуры: металл гальванизированный / металл крашенный
 Цвет арматуры: полированная медь / хром / черный / золото
 Материал плафона: акрил
 Цвет плафона: белый

POLIS





rotary fitting – direct the light either to the wall or from the wall –
поворотный механизм, можно направить свет как на стену, так и от стены



A2029AP-1PB

↓ 84 ↔ 7 ↗ 10
♀ 10W | LED, 480LM,
4000K, CRI/RA≥80



Fixture material: metal painted / metal plated
Fixture colour: black / gold / polished brass / chrome
Shade material: acrylic
Shade colour: white

A2029AP-1GO

↓ 84 ↔ 7 ↗ 10
♀ 10W | LED, 600LM,
4000K, CRI/RA≥80



Материал арматуры: металл крашенный / металл гальванизированный
Цвет арматуры: черный / золото / полированная медь / хром
Материал плафона: акрил
Цвет плафона: белый

A2029AP-1CC

↓ 84 ↔ 7 ↗ 10
♀ 10W | LED, 500LM,
4000K, CRI/RA≥80



A2029AP-1BK

↓ 84 ↔ 7 ↗ 10
♀ 10W | LED, 400LM,
4000K, CRI/RA≥80



A2028AP-1CC

↓ 84 ↔ 6 ↗ 14
♀ 8W | LED, 460LM,
4000K, CRI/RA≥80

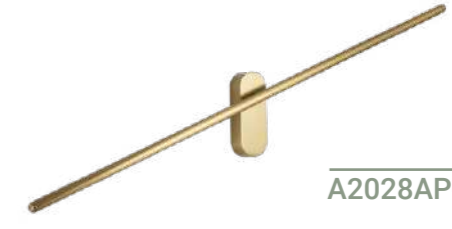

A2028AP-1PB

↓ 84 ↔ 6 ↗ 14
♀ 8W | LED, 460LM,
4000K, CRI/RA≥80



A2028AP-1BK

↓ 84 ↔ 6 ↗ 14
♀ 9W | LED, 600LM,
4000K, CRI/RA≥80



A2028AP-1GO

↓ 84 ↔ 6 ↗ 14
♀ 9W | LED, 600LM,
4000K, CRI/RA≥80



PRIMA



Fixture material: metal plated / metal painted
Fixture colour: polished brass / chrome / black / gold
Shade material: acrylic
Shade colour: white

Материал арматуры: металл гальванизированный / металл крашенный
Цвет арматуры: полированная медь / хром / черный / золото
Материал плафона: акрил
Цвет плафона: белый



Fixture material: metal painted
 Fixture colour: black / white
 Shade material: acrylic
 Shade colour: white

Материал арматуры: металл крашенный
 Цвет арматуры: черный / белый
 Материал плафона: акрил
 Цвет плафона: белый



NEW

A2216AP-1WH

↑ 13 ↔ 5 ↗ 99
 ∅ 22W | LED, 1830LM,
 4000K, CRI/RA≥80



NEW

A2216AP-1BK

↑ 13 ↔ 5 ↗ 99
 ∅ 22W | LED, 1570LM,
 4000K, CRI/RA≥80

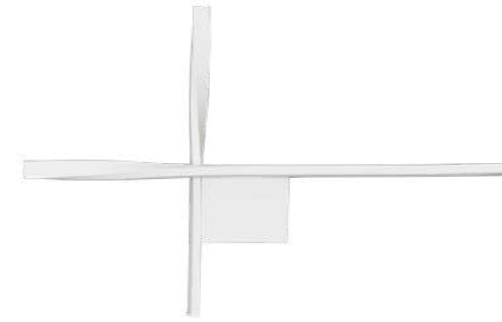

NEW

A2217AP-2WH

↑ 36 ↔ 5 ↗ 56
 ∅ 14W | LED, 1080LM,
 4000K, CRI/RA≥80



NEW

A2217AP-2BK

↑ 36 ↔ 5 ↗ 56
 ∅ 14W | LED, 740LM,
 4000K, CRI/RA≥80

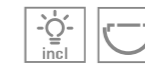

Fixture material: metal painted
 Fixture colour: black / white
 Shade material: acrylic
 Shade colour: white

Материал арматуры: металл крашенный
 Цвет арматуры: черный / белый
 Материал плафона: акрил
 Цвет плафона: белый

ACRUX

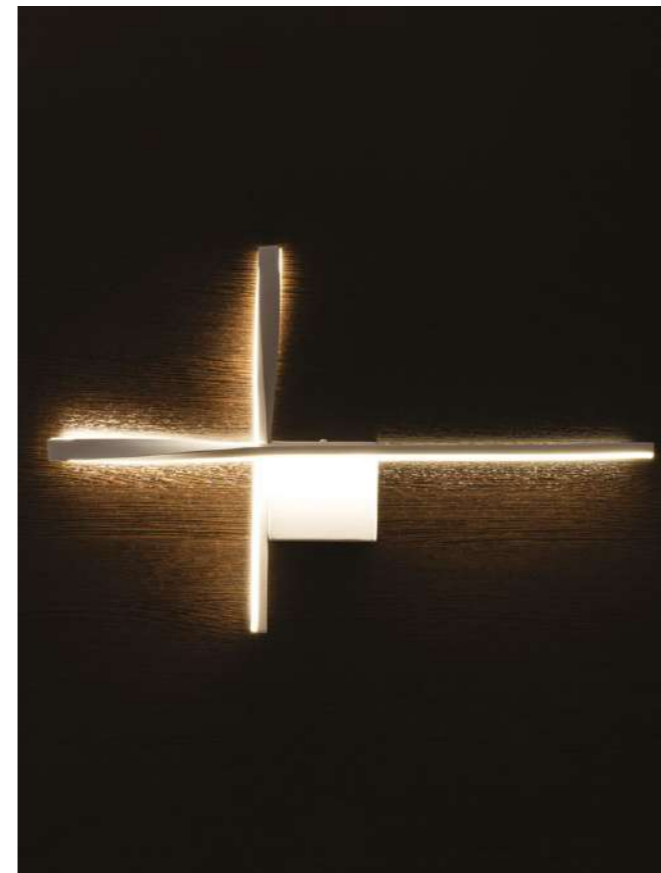



A8046AP-1PB

↓ 12 ↔ 21 ↗ 57
 ♀ 10W | LED, 700LM,
 4000K, CRI/RA≥80



A8048AP-1PB

↓ 12 ↔ 24 ↗ 71
 ♀ 10W | LED, 700LM,
 4000K, CRI/RA≥80



CHIANTI



A6508AP-1AB

↓ 10 ↔ 19 ↗ 57
 ♀ 8W | LED, 510LM, 4000K, CRI/RA≥80



A6512AP-1AB

↓ 10 ↔ 19 ↗ 71
 ♀ 12W | LED, 750LM, 4000K, CRI/RA≥80



Fixture material: metal plated
 Fixture colour: antique bronze
 Shade material: metal plated
 Shade colour: antique bronze

Материал арматуры: металл гальванизированный
 Цвет арматуры: античная бронза
 Материал плафона: металл гальванизированный
 Цвет плафона: античная бронза

Fixture material: metal plated
 Fixture colour: polished brass
 Shade material: metal plated, acrylic
 Shade colour: polished brass

Материал арматуры: металл гальванизированный
 Цвет арматуры: полированная медь
 Материал плафона: металл гальванизированный, акрил
 Цвет плафона: полированная медь

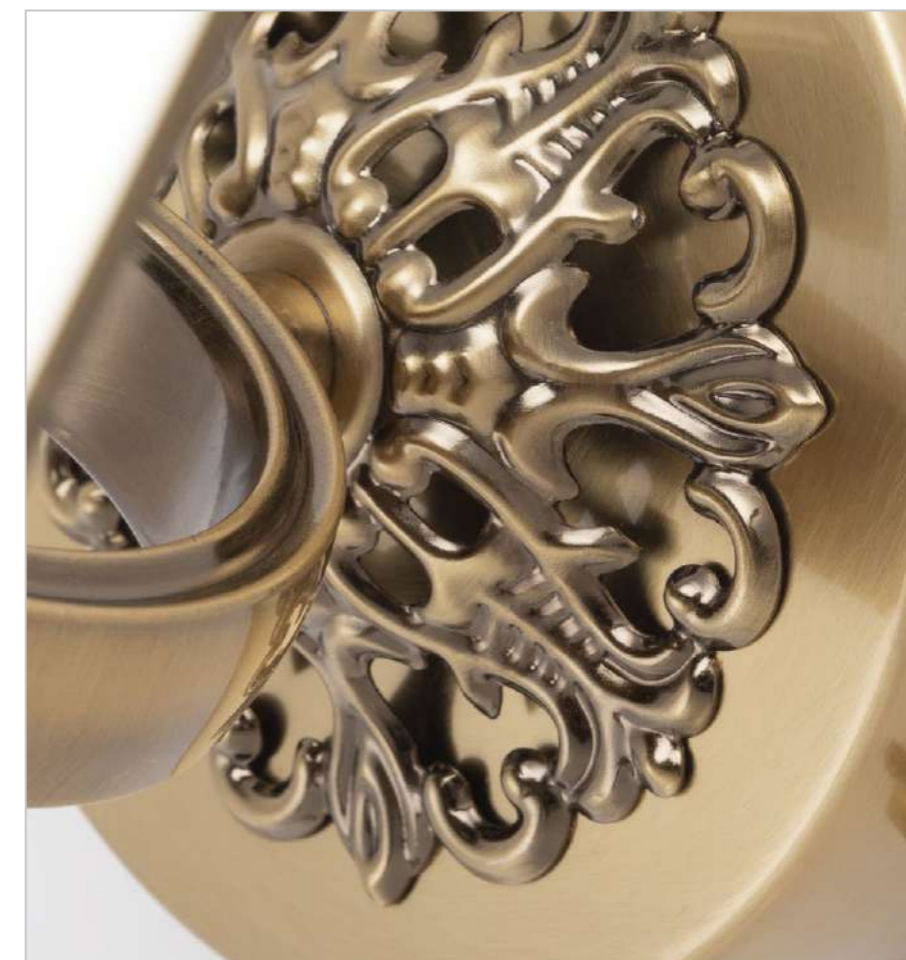



A6308AP-1AB

↑ 13 ↔ 22 ↗ 64
 ♀ 8W | LED, 405LM, 3000K, CRI/RA≥80



A6312AP-1AB

↑ 13 ↔ 22 ↗ 78
 ♀ 12W | LED, 585LM, 3000K, CRI/RA≥80



Fixture material: metal plated
 Fixture colour: antique bronze
 Shade material: metal plated, acrylic
 Shade colour: antique bronze

Материал арматуры: металл
 гальванизированный
 Цвет арматуры: античная бронза
 Материал плафона: металл
 гальванизированный, акрил
 Цвет плафона: античная бронза

NAPOLI



A6708AP-1AB

↑ 13 ↔ 24 ↗ 56
 ♀ 8W | LED, 410LM, 3000K, CRI/RA≥80



A6712AP-1AB

↑ 13 ↔ 24 ↗ 70
 ♀ 12W | LED, 600LM, 3000K, CRI/RA≥80



Fixture material: metal plated
 Fixture colour: antique bronze
 Shade material: metal plated, acrylic
 Shade colour: antique bronze

Материал арматуры: металл
 гальванизированный
 Цвет арматуры: античная бронза
 Материал плафона: металл
 гальванизированный, акрил
 Цвет плафона: античная бронза





A7908AP-1BK

↓ 12 ↔ 20 ↗ 49
 ♀ 8W | LED, 370LM,
 4000K, CRI/RA≥80



A7912AP-1BK

↓ 12 ↔ 20 ↗ 63
 ♀ 12W | LED, 550LM,
 4000K, CRI/RA≥80



Fixture material: metal painted, plated
 Fixture colour: black
 Shade material: metal painted, plated, acrylic
 Shade colour: black

Материал арматуры: металл крашенный, гальванизированный
 Цвет арматуры: черный
 Материал плафона: металл крашенный, гальванизированный, акрил
 Цвет плафона: черный



A1709AP-1AB

↓ 5 ↔ 48 ↗ 21
 ♀ 9W | LED, 540LM,
 4000K, CRI/RA≥80
 ∇ 5X17



A1709AP-1BK

↓ 5 ↔ 48 ↗ 21
 ♀ 9W | LED, 540LM,
 4000K, CRI/RA≥80
 ∇ 5X17



A1709AP-1CC

↓ 5 ↔ 48 ↗ 21
 ♀ 9W | LED, 540LM,
 4000K, CRI/RA≥80
 ∇ 5X17



A1709AP-1GO

↓ 5 ↔ 48 ↗ 21
 ♀ 9W | LED, 540LM,
 4000K, CRI/RA≥80
 ∇ 5X17



A1711AP-1AB

↓ 5 ↔ 60 ↗ 21
 ♀ 11W | LED, 800LM,
 4000K, CRI/RA≥80
 ∇ 5X17



A1711AP-1BK

↓ 5 ↔ 60 ↗ 21
 ♀ 11W | LED, 800LM,
 4000K, CRI/RA≥80
 ∇ 5X17



A1711AP-1CC

↓ 5 ↔ 60 ↗ 21
 ♀ 11W | LED, 800LM,
 4000K, CRI/RA≥80
 ∇ 5X17



A1711AP-1GO

↓ 5 ↔ 60 ↗ 21
 ♀ 11W | LED, 800LM,
 4000K, CRI/RA≥80
 ∇ 5X17



Fixture material: metal plated / metal painted
 Fixture colour: antique bronze / black / chrome / gold
 Shade material: metal plated / metal painted
 Shade colour: antique bronze / black / chrome / gold

Материал арматуры: металл гальванизированный / металл крашенный
 Цвет арматуры: античная бронза / черный / хром / золото
 Материал плафона: металл гальванизированный / металл крашенный
 Цвет плафона: античная бронза / черный / хром / золото

HARRISON





A5308AP-1CC

↓5 ↔ 13 ↗45
 ♀ 8W | LED, 375LM,
 3000K, CRI/RA≥80



A5308AP-1WH

↓5 ↔ 13 ↗45
 ♀ 8W | LED, 375LM,
 3000K, CRI/RA≥80



A7708AP-1BK

↓6 ↔ 15 ↗45
 ♀ 8W | LED, 270LM,
 4000K, CRI/RA≥80



A5312AP-1CC

↓5 ↔ 13 ↗60
 ♀ 12W | LED, 550LM,
 3000K, CRI/RA≥80



A5312AP-1WH

↓5 ↔ 13 ↗60
 ♀ 12W | LED, 550LM,
 3000K, CRI/RA≥80



A7712AP-1BK

↓6 ↔ 15 ↗60
 ♀ 12W | LED, 370LM,
 4000K, CRI/RA≥80



A7031AP-1CC

↓9 ↔ 16 ↗54
 ♀ 12W | LED, 670LM,
 4000K, CRI/RA≥80



A7031AP-1AB

↓9 ↔ 16 ↗54
 ♀ 12W | LED, 670LM,
 4000K, CRI/RA≥80



Fixture material: metal plated
 Fixture colour: antique bronze / chrome
 Shade material: metal plated, acrylic
 Shade colour: antique bronze / chrome

Материал арматуры: металл гальванизированный
 Цвет арматуры: античная бронза / хром
 Материал плафона: металл гальванизированный, акрил
 Цвет плафона: античная бронза / хром

sessing range - 3-5 meters.
 working period - 2 minutes
 дистанция срабатывания 3-5 метров.
 период работы 2 минуты

Fixture material: metal painted / metal plated
 Fixture colour: black / chrome / white
 Shade material: metal painted / metal plated,
 acrylic / metal painted, acrylic
 Shade colour: black / chrome / white

Материал арматуры: металл крашенный /
 металл гальванизированный
 Цвет арматуры: черный / хром / белый
 Материал плафона: металл крашенный
 / металл гальванизированный, акрил /
 металл крашенный, акрил
 Цвет плафона: черный / хром / белый





A8025AP-1GO

↓5 ↔ 11 ↗46
 ♀ 8W | LED, 500LM,
 4000K, CRI/RA≥80



A8025AP-1BK

↓5 ↔ 11 ↗46
 ♀ 8W | LED, 440LM,
 4000K, CRI/RA≥80



A8025AP-1CC

↓5 ↔ 11 ↗46
 ♀ 8W | LED, 540LM,
 4000K, CRI/RA≥80



A8025AP-1WH

↓5 ↔ 11 ↗46
 ♀ 8W | LED, 540LM,
 4000K, CRI/RA≥80



A8025AP-1PB

↓5 ↔ 11 ↗46
 ♀ 8W | LED, 500LM,
 4000K, CRI/RA≥80



A8027AP-1GO

↓5 ↔ 11 ↗66
 ♀ 12W | LED, 720LM,
 4000K, CRI/RA≥80



A8027AP-1BK

↓5 ↔ 11 ↗66
 ♀ 12W | LED, 720LM,
 4000K, CRI/RA≥80



A8027AP-1CC

↓5 ↔ 11 ↗66
 ♀ 12W | LED, 720LM,
 4000K, CRI/RA≥80



A8027AP-1WH

↓5 ↔ 11 ↗66
 ♀ 12W | LED, 720LM,
 4000K, CRI/RA≥80



A8027AP-1PB

↓5 ↔ 11 ↗66
 ♀ 12W | LED, 720LM,
 4000K, CRI/RA≥80



Fixture material: metal painted / metal plated
 Fixture colour: gold / black / chrome /
 polished brass / white
 Shade material: metal painted, acrylic / metal
 plated, acrylic
 Shade colour: gold / black / chrome / polished
 brass / white

Материал арматуры: металл крашенный / металл
 гальванизированный
 Цвет арматуры: золото / черный / хром / полированная медь / белый
 Материал плафона: металл крашенный, акрил / металл
 гальванизированный, акрил
 Цвет плафона: золото / черный / хром / полированная медь / белый

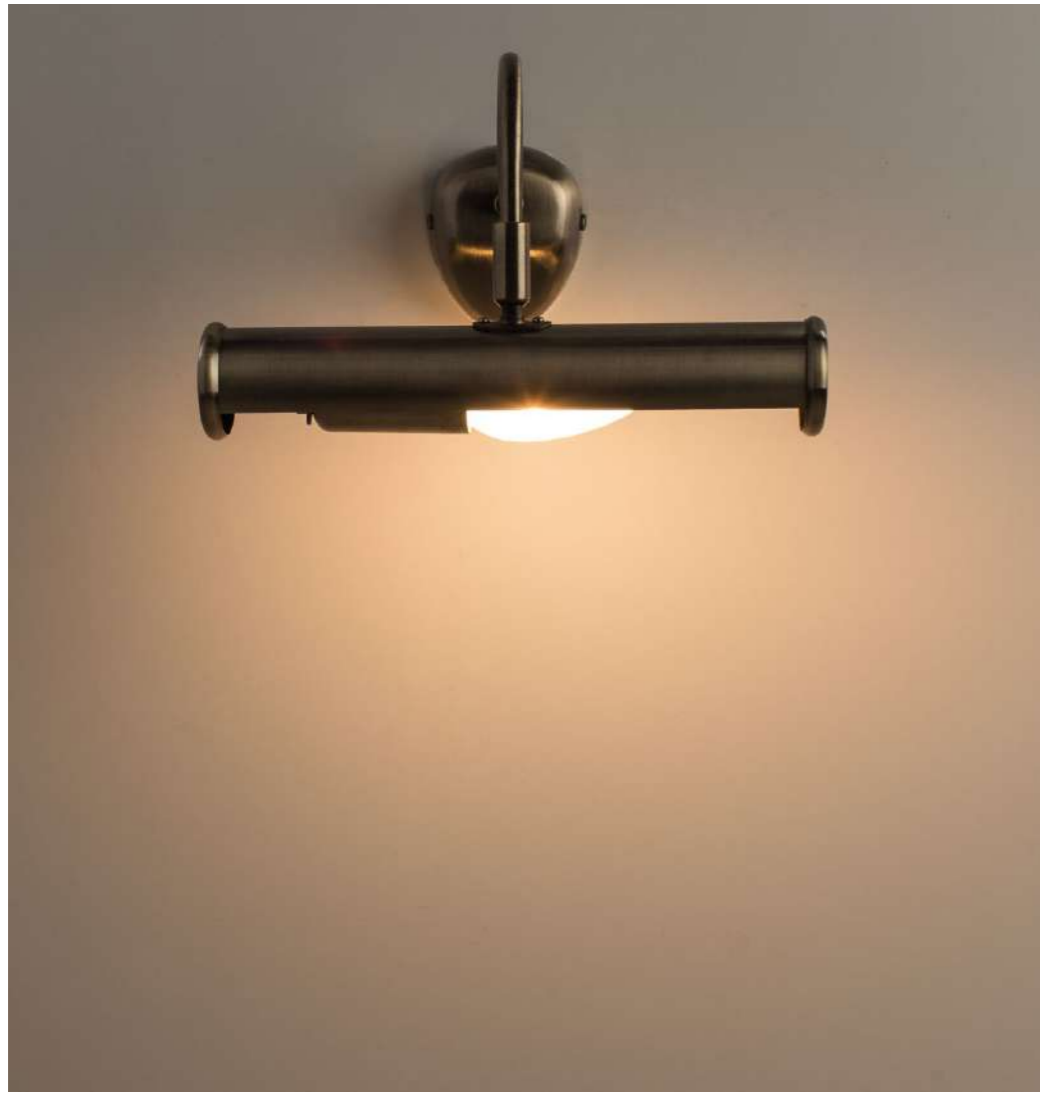

A5023AP-1AB

↑ 19 ↔ 22 ↗ 25
 ♀ 40W | E14



Fixture material: metal plated
 Fixture colour: antique bronze
 Shade material: metal plated
 Shade colour: antique bronze

Материал арматуры: металл
 гальванизированный
 Цвет арматуры: античная бронза
 Материал плафона: металл
 гальванизированный
 Цвет плафона: античная бронза



A5009AP-2AB

↑ 17 ↔ 21 ↗ 37
 ♀ 2X40W | E14



Fixture material: metal plated
 Fixture colour: antique bronze
 Shade material: metal plated
 Shade colour: antique bronze

Материал арматуры: металл
 гальванизированный
 Цвет арматуры: античная бронза
 Материал плафона: металл
 гальванизированный
 Цвет плафона: античная бронза

PICTURE LIGHTS





Tradiziōne

ТРАДИЦИОННЫЕ

все иллюстрации созданы инструментами нейросети
#Midjourney



A1043SP-1BK

↓ 24 ∅ 20
 ♀ 40,3W | E14
 ⚡ 81 ∇ 10

A1028PL-8BK

↓ 43 ∅ 65
 ♀ 8X40W | E14
 ∇ 12



A1028PL-6BK

↓ 43 ∅ 50
 ♀ 6X40W | E14
 ∇ 12



Fixture material: metal painted, metal plated
 Fixture colour: black
 Shade material: crystal

Материал арматуры: металл крашенный,
 металл гальванизированный
 Цвет арматуры: черный
 Материал плафона: хрусталь

AMBER



A1043SP-6BK

↓ 24 ∅ 50
 ♀ 6X40,3W | E14
 ⚡ 78 ∇ 15



A1043AP-2BK

↓ 24 ↔ 20 ↗ 14
 ♀ 2X40,3W | E14



A1028AP-2BK

↓ 21 ↔ 24 ↗ 15
 ♀ 2X40W | E14

Fixture material: metal painted,
 metal plated
 Fixture colour: black
 Shade material: crystal
 Shade colour: gold

Материал арматуры:
 металл крашенный, металл
 гальванизированный
 Цвет арматуры: черный
 Материал плафона: хрусталь
 Цвет плафона: золото





Fixture material: metal plated
 Fixture colour: polished brass
 Shade material: metal plated, crystal
 Shade colour: polished brass

Материал арматуры: металл гальванизированный
 Цвет арматуры: полированная медь
 Материал плафона: металл, хрусталь
 Цвет плафона: полированная медь



A1037AP-1PB

↑ 18 ↔ 22 ↗ 16
 ♀ 60W | E14



A1039SP-10BK

↑ 35 ∅ 51
 ♀ 10X40W | E14
 ∞ 65 ∇ 15



A1039AP-2BK

↑ 35 ↔ 23 ↗ 11
 ♀ 2X40W | E14



A1037SP-8PB

↑ 19 ∅ 60
 ♀ 8X60W | E14
 ∞ 100 ∇ 12



A1037SP-6PB

↑ 19 ∅ 50
 ♀ 6X60W | E14
 ∞ 100 ∇ 12



Fixture material: metal painted,
 metal plated
 Fixture colour: black
 Shade material: crystal

Материал арматуры:
 металл крашенный, металл
 гальванизированный
 Цвет арматуры: черный
 Материал плафона: хрусталь

AMELIA



A1049AP-2GO

↓ 22 ↔ 10 ↗ 15
 ∅ 2X40W | G9



A1049SP-12GO

↓ 22 ∅ 62
 ∅ 12X40W | G9
 ⌀ 74 ∇ 12



A1049SP-16GO

↓ 22 ∅ 76
 ∅ 16X40W | G9
 ⌀ 74 ∇ 12



Fixture material: metal plated
 Fixture colour: gold
 Shade material: crystal
 Shade colour: clear

Материал арматуры: металл
 гальванизированный
 Цвет арматуры: золото
 Материал плафона: хрусталь
 Цвет плафона: прозрачный



A1053SP-10PB

↓ 27 ∅ 51
 ∅ 10X40W | G9
 ⌀ 85 ∇ 12



A1053SP-14PB

↓ 27 ∅ 61
 ∅ 14X40W | G9
 ⌀ 85 ∇ 15



A1053AP-2PB

↓ 27 ↔ 23 ↗ 14
 ∅ 2X40W | G9

Fixture material: metal plated
 Fixture colour: polished brass
 Shade material: glass
 Shade colour: clear

Материал арматуры: металл
 гальванизированный
 Цвет арматуры: полированная медь
 Материал плафона: стекло
 Цвет плафона: прозрачный

ALYA





Fixture material: metal plated
 Fixture colour: chrome
 Shade material: glass
 Shade colour: clear

Материал арматуры: металл
 гальванизированный
 Цвет арматуры: хром
 Материал плафона: стекло
 Цвет плафона: прозрачный



A1034AP-2CC

↑ 30 ↔ 15 ↗ 12
 ♀ 2X60W | E14



A1034SP-12CC

↑ 45 ∅ 50
 ♀ 12X60W | E14
 ⚙ 70 ∇ 12



A1034SP-16CC

↑ 45 ∅ 60
 ♀ 16X60W | E14
 ⚙ 70 ∇ 12



A1007SP-12GO

↑ 33 ∅ 60
 ♀ 12X40W | G9
 ⚙ 40 ∇ 15



A1007SP-10GO

↑ 33 ∅ 50
 ♀ 10X40W | G9
 ⚙ 40 ∇ 12



A1007AP-2GO

↑ 50 ↔ 20 ↗ 10
 ♀ 2X40W | G9

Fixture material: metal plated
 Fixture colour: gold
 Shade material: metal plated
 Shade colour: clear

Материал арматуры: металл
 гальванизированный
 Цвет арматуры: золото
 Материал плафона: металл, стекло
 Цвет плафона: прозрачный

ACAPULCO





NEW
A1064AP-2CC

↓ 40 ↔ 25 ↗ 15
♀ 2X40W | E14

Fixture material: metal plated
Fixture colour: chrome
Shade material: glass
Shade colour: clear

Материал арматуры: металл
гальванизированный
Цвет арматуры: хром
Материал плафона: стекло
Цвет плафона: прозрачный



NEW
A1063AP-2CC

↓ 50 ↔ 18 ↗ 11
♀ 2X40W | E14



NEW
A1063AP-2AB

↓ 50 ↔ 18 ↗ 12
♀ 2X40W | E14

ALBALI



NEW
A1064PL-12CC

↓ 78 ∅ 81
♀ 12X40W | E14
∇ 15



NEW
A1064PL-10CC

↓ 78 ∅ 60
♀ 10X40W | E14
∇ 15



Fixture material: metal plated
Fixture colour: chrome / antique bronze
Shade material: glass
Shade colour: clear

Материал арматуры: металл
гальванизированный
Цвет арматуры: хром / античная бронза
Материал плафона: стекло
Цвет плафона: прозрачный





A1052AP-2GO

↑ 28 ↔ 20 ↗ 14
 ♀ 2X40W | E14



A1051SP-8CC

↑ 33 ∅ 52
 ♀ 8X40W | E14
 ⚙ 54 ∇ 13



A1051SP-10CC

↑ 33 ∅ 62
 ♀ 10X40W | E14
 ⚙ 54 ∇ 15



A1051AP-2CC

↑ 26 ↔ 21 ↗ 14
 ♀ 2X40W | E14



A1052SP-8GO

↑ 35 ∅ 52
 ♀ 8X40W | E14
 ⚙ 50 ∇ 13



A1052SP-10GO

↑ 35 ∅ 61
 ♀ 10X40W | E14
 ⚙ 50 ∇ 15



Fixture material: metal plated
 Fixture colour: chrome / gold
 Shade material: crystal
 Shade colour: clear

Материал арматуры: металл
 гальванизированный
 Цвет арматуры: хром / золото
 Материал плафона: хрусталь
 Цвет плафона: прозрачный



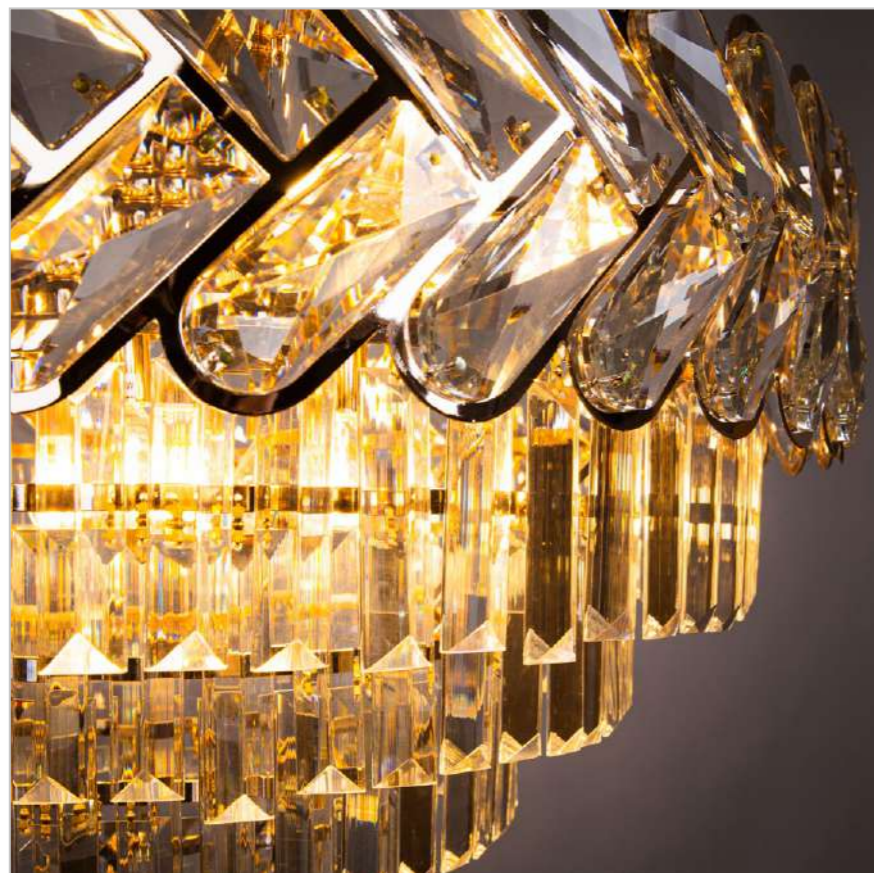

Fixture material: metal plated
 Fixture colour: gold
 Shade material: crystal
 Shade colour: clear

Материал арматуры: металл
 гальванизированный
 Цвет арматуры: золото
 Материал плафона: хрусталь
 Цвет плафона: прозрачный



A1027SP-10CC

↑ 47 ∅ 61
 ♀ 10X40W | E14
 ⌀ 50 ∇ 10



A1027SP-8CC

↑ 41 ∅ 51
 ♀ 8X40W | E14
 ⌀ 50 ∇ 10



A1025SP-10GO

↑ 40 ∅ 60
 ♀ 10X40W | E14
 ⌀ 50 ∇ 10



A1025SP-8GO

↑ 34 ∅ 50
 ♀ 8X40W | E14
 ⌀ 50 ∇ 10



Fixture material: metal plated
 Fixture colour: chrome
 Shade material: crystal
 Shade colour: clear

Материал арматуры: металл
 гальванизированный
 Цвет арматуры: хром
 Материал плафона: хрусталь
 Цвет плафона: прозрачный



ELLIE



A1009AP-2CC

↓ 31 ↔ 26 ↗ 15
 ♀ 2X60W | ⚡ 27

Fixture material: metal plated
 Fixture colour: chrome
 Shade material: glass
 Shade colour: white

Материал арматуры: металл
 гальванизированный
 Цвет арматуры: хром
 Материал плафона: стекло
 Цвет плафона: белый



A1004SP-8SI

↓ 41 ∅ 50
 ♀ 8X60W | E14
 ⚡ 36 ∇ 15



A1004PL-10SI

↓ 59 ∅ 60
 ♀ 10X60W | E14
 ∇ 25



MUSCIDA



A1009SP-10CC

↓ 51 ∅ 63
 ♀ 10X60W | ⚡ 27
 ⚡ 50 ∇ 10



A1009SP-6CC

↓ 44 ∅ 47
 ♀ 6X60W | ⚡ 27
 ⚡ 50 ∇ 10



Fixture material: metal plated
 Fixture colour: silver
 Shade material: metal plated
 Shade colour: silver

Материал арматуры: металл
 гальванизированный
 Цвет арматуры: серебро
 Материал плафона: металл, хрусталь
 Цвет плафона: серебро

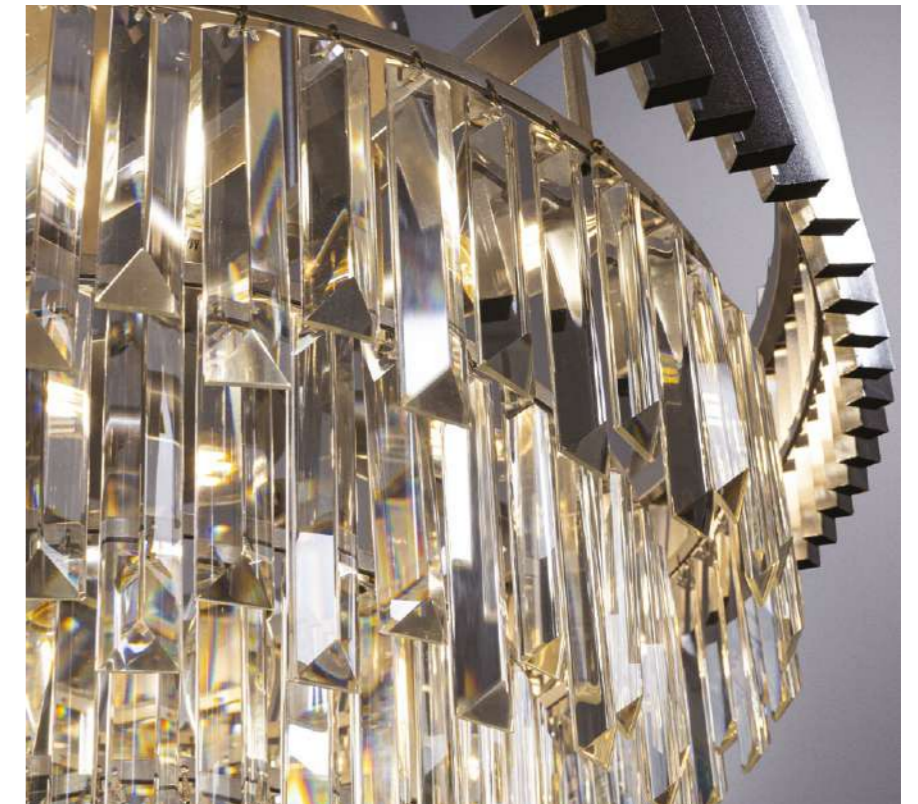



A1008AP-2GO

↓ 23 ↔ 28 ↗ 17
 ♀ 2X60W | E14



A1002LM-8CC

↓ 28 ∅ 60
 ♀ 8X60W | E14
 ⚙ 52 ∇ 12



A1002LM-6CC

↓ 23 ∅ 46
 ♀ 6X60W | E14
 ⚙ 52 ∇ 12



DIADEM



A1008LM-6GO

↓ 36 ∅ 46
 ♀ 6X60W | E14
 ⚙ 40 ∇ 12



A1008LM-8GO

↓ 40 ∅ 60
 ♀ 8X60W | E14
 ⚙ 40 ∇ 12



Fixture material: metal plated, lether
 Fixture colour: gold
 Shade material: crystal
 Shade colour: beige

Материал арматуры: металл
 гальванизированный, кожа
 Цвет арматуры: золото
 Материал плафона: хрусталь
 Цвет плафона: бежевый



A1002AP-2CC

↓ 23 ↔ 28 ↗ 17
 ♀ 2X60W | E14

Fixture material: metal plated, lether
 Fixture colour: chrome
 Shade material: crystal
 Shade colour: white

Материал арматуры: металл
 гальванизированный, кожа
 Цвет арматуры: хром
 Материал плафона: хрусталь
 Цвет плафона: белый





NEW

A1062SP-6CC

↓ 16 ∅ 55
 ∅ 6X40W | E14
 ⚙ 100 ∇ 12



NEW

A1062AP-2CC

↓ 15 ↔ 24 ∇ 14
 ∅ 2X40W | E14

Fixture material: metal plated
 Fixture colour: chrome
 Shade material: crystal
 Shade colour: clear

Материал арматуры: металл
 гальванизированный
 Цвет арматуры: хром
 Материал плафона: хрусталь
 Цвет плафона: прозрачный



A1006SP-8CC

↓ 38 ∅ 50
 ∅ 8X60W | E14
 ⚙ 40 ∇ 15



Fixture material: metal plated
 Fixture colour: chrome
 Shade material: crystal
 Shade colour: clear

Материал арматуры: металл
 гальванизированный
 Цвет арматуры: хром
 Материал плафона: хрусталь
 Цвет плафона: прозрачный



A1006AP-2CC

↓ 38 ↔ 25 ∇ 17
 ∅ 2X60W | E14

A1006SP-10CC

↓ 39 ∅ 60
 ∅ 10X60W | E14
 ⚙ 40 ∇ 15



WEZEN





A1003LM-8CC

↓ 22 ∅ 60
 ♀ 8X60W | E14
 ⚙ 120 ∇ 12



A1003AP-1CC

↓ 23 ↔ 16 ↗ 10
 ♀ 60W | E14



A1003LM-12CC

↓ 22 ∅ 80
 ♀ 12X60W | E14
 ⚙ 120 ∇ 12



Fixture material: metal plated
 Fixture colour: chrome
 Shade material: crystal
 Shade colour: clear

Материал арматуры: металл
 гальванизированный
 Цвет арматуры: хром
 Материал плафона: хрусталь
 Цвет плафона: прозрачный





A2719AP-2CC

↑ 25 ↔ 26 ↗ 13
 ♀ 2X60W | ⚡ 27



A2719SP-8GO

↑ 43 ∅ 54
 ♀ 8X60W | E27
 ⚡ 30 ∇ 10



A2719SP-6GO

↑ 37 ∅ 44
 ♀ 6X60W | E27
 ⚡ 30 ∇ 10



A2719AP-2GO

↑ 25 ↔ 26 ↗ 13
 ♀ 2X60W | ⚡ 27



A2719SP-8CC

↑ 43 ∅ 54
 ♀ 8X60W | ⚡ 27
 ⚡ 30 ∇ 10



A2719SP-6CC

↑ 37 ∅ 44
 ♀ 6X60W | ⚡ 27
 ⚡ 30 ∇ 10



Fixture material: metal plated
 Fixture colour: gold / chrome
 Shade material: metal plated, crystal
 Shade colour: clear

Материал арматуры: металл гальванизированный
 Цвет арматуры: золото / хром
 Материал плафона: металл, хрусталь
 Цвет плафона: прозрачный

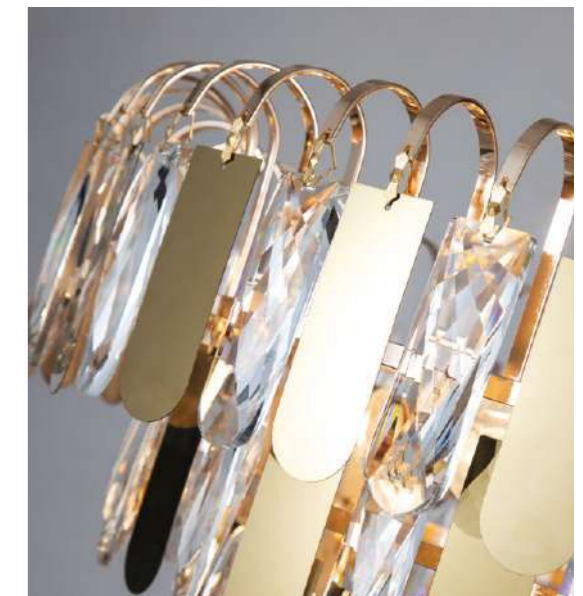



A1005AP-2GO

↓ 31 ↔ 21 ↗ 13
 ♀ 2X60W | E14



A1054AP-1CC

↓ 27 ↔ 25 ↗ 15
 ♀ 40W | E14



A1054PL-6CC

↓ 38 ∅ 50
 ♀ 6X40W | E14
 ∇ 35



A1054PL-9CC

↓ 40 ∅ 65
 ♀ 9X40W | E14
 ∇ 50



A1054AP-1GO

↓ 27 ↔ 25 ↗ 15
 ♀ 40W | E14



A1054PL-6GO

↓ 38 ∅ 50
 ♀ 6X40W | E14
 ∇ 35



A1054PL-9GO

↓ 40 ∅ 65
 ♀ 9X40W | E14
 ∇ 50



A1005PL-10GO

↓ 52 ∅ 60
 ♀ 10X60W | E14
 ∇ 25



A1005PL-8GO

↓ 52 ∅ 50
 ♀ 8X60W | E14
 ∇ 22



Fixture material: metal plated
 Fixture colour: gold
 Shade material: metal plated
 Shade colour: clear

Материал арматуры: металл
 гальванизированный
 Цвет арматуры: золото
 Материал плафона: металл,
 хрусталь
 Цвет плафона: прозрачный

Fixture material: metal plated
 Fixture colour: chrome / gold
 Shade material: glass
 Shade colour: clear / amber

Материал арматуры: металл
 гальванизированный
 Цвет арматуры: хром / золото
 Материал плафона: стекло
 Цвет плафона: прозрачный /
 янтарный

ELLA





NEW
A4079AP-1CC

↓ 22 ↔ 19 ↗ 12
♀ 40W | E14

Fixture material: metal plated
Fixture colour: chrome
Shade material: fabric
Shade colour: white

Материал арматуры: металл
гальванизированный
Цвет арматуры: хром
Материал плафона: ткань
Цвет плафона: белый



NEW
A4079LM-6CC

↓ 22 ∅ 55
♀ 6X40W | E14
⌘ 98 ∇ 12



NEW
A4079LM-8CC

↓ 22 ∅ 75
♀ 8X40W | E14
⌘ 98 ∇ 12



NEW
A4076LM-8CC

↓ 22 ∅ 86
♀ 8X40W | E14
⌘ 50 ∇ 12



NEW
A4076LM-5CC

↓ 22 ∅ 70
♀ 5X40W | E14
⌘ 50 ∇ 12



FANTASIA



NEW
A4076AP-1CC

↓ 22 ↔ 16 ↗ 26
♀ 40W | E14

Fixture material: metal plated
Fixture colour: chrome
Shade material: fabric, glass
Shade colour: white

Материал арматуры: металл
гальванизированный
Цвет арматуры: хром
Материал плафона: ткань, стекло
Цвет плафона: белый





A3990SP-1CC

↓ 24 ∅ 20
 ♀ 60W | E27
 ⚙ 96 ∇ 12



A3990LT-1CC

↓ 45 ∅ 25
 ♀ 60W | E27
 ⚙ 150

A3990PN-1CC

↓ 150 ∅ 35
 ♀ 60W | E27
 ⚙ 180



A3990AP-1CC

↓ 25 ↔ 18 ↗ 24
 ♀ 40W | E14



A3990LM-6CC

↓ 45 ∅ 70
 ♀ 6X60W | E14
 ⚙ 70 ∇ 11



Fixture material: metal plated, glass
 Fixture colour: chrome
 Shade material: fabric
 Shade colour: white

Материал арматуры: металл
 гальванизированный, стекло
 Цвет арматуры: хром
 Материал плафона: ткань
 Цвет плафона: белый





A4047AP-1CC

↑ 22 ↔ 15 ↗ 24
 ♀ 40W | E14



Fixture material: metal plated, crystal
 Fixture colour: chrome
 Shade material: fabric
 Shade colour: white

Материал арматуры: металл гальванизированный, хрусталь
 Цвет арматуры: хром
 Материал плафона: ткань
 Цвет плафона: белый



A4038PL-8CC

↑ 32 ∅ 75
 ♀ 8X40W | E14
 ♀ 10



A4038PL-5CC

↑ 32 ∅ 60
 ♀ 5X40W | E14
 ♀ 10



A4047PL-8CC

↑ 35 ∅ 79
 ♀ 8X40W | E14
 ♀ 14



A4047PL-5CC

↑ 34 ∅ 64
 ♀ 5X40W | E14
 ♀ 14



A4038AP-1CC

↑ 25 ↔ 14 ↗ 23
 ♀ 40W | E14



Fixture material: metal plated, crystal
 Fixture colour: chrome
 Shade material: fabric
 Shade colour: white

Материал арматуры: металл гальванизированный, хрусталь
 Цвет арматуры: хром
 Материал плафона: ткань
 Цвет плафона: белый



IBIZA



A5896LM-6CC

↓ 30 ∅ 65
 ♀ 6X60W | E14
 ⚙ 90 ∇ 12



A5896LM-6PB

↓ 30 ∅ 65
 ♀ 6X60W | E14
 ⚙ 90 ∇ 12



A5896LT-1PB

↓ 50 ↔ 25 ↗ 25
 ♀ 60W | E27
 ∅ 180



A5896LT-1CC

↓ 50 ↔ 25 ↗ 25
 ♀ 60W | E27
 ∅ 180



A5896PN-1PB

↓ 146 ↔ 30 ↗ 30
 ♀ 60W | E27
 ∅ 200



A5896PN-1CC

↓ 146 ↔ 30 ↗ 30
 ♀ 60W | E27
 ∅ 200



Fixture material: metal plated
 Fixture colour: chrome / polished brass
 Shade material: fabric
 Shade colour: white

Материал арматуры: металл
 гальванизированный
 Цвет арматуры: хром /
 полированная медь
 Материал плафона: ткань
 Цвет плафона: белый



A5896AP-1CC

↓ 30 ↔ 14 ↗ 25
 ♀ 60W | E14



A5896AP-1PB

↓ 30 ↔ 14 ↗ 25
 ♀ 60W | E14



A4027AP-1PB

↑ 32 ↔ 11 ↗ 18
 ♀ 40W | E14



A4027LT-1PB

↑ 62 ∅ 36
 ♀ 60W | E27
 ⚡ 180

Fixture material: metal plated, glass
 Fixture colour: polished brass
 Shade material: fabric
 Shade colour: cream

Материал арматуры: металл
 гальванизированный, стекло
 Цвет арматуры: полированная медь
 Материал плафона: ткань
 Цвет плафона: кремовый



A8555AP-2AB

↑ 26 ↔ 35 ↗ 20
 ♀ 2X40W | E14

Fixture material: metal plated, glass
 Fixture colour: antique bronze
 Shade material: fabric
 Shade colour: white

Материал арматуры: металл
 гальванизированный, стекло
 Цвет арматуры: античная бронза
 Материал плафона: ткань
 Цвет плафона: белый



A8555SP-6AB

↓ 30 ∅ 55
 ♀ 6X40W | E14
 ⚡ 70 ⚡ 12



JENNIFER



A4027LM-6PB

↑ 48 ∅ 65
 ♀ 6X40W | E14
 ⚡ 100 ⚡ 12





A7301AP-1PB

↑ 29 ↔ 14 ↗ 34
 ♀ 40W | E27



A7301LT-1PB

↑ 56 ∅ 30
 ♀ 40W | E27
 ♣ 150



A7301PN-1PB

↑ 171 ∅ 40
 ♀ 60W | E27
 ♣ 150



A7301LM-6PB

↑ 48 ∅ 72
 ♀ 6X40W | E14
 ♣ 37 ♣ 11



Fixture material: metal plated, glass
 Fixture colour: polished brass
 Shade material: fabric
 Shade colour: white

Материал арматуры: металл гальванизированный, стекло
 Цвет арматуры: полированная медь
 Материал плафона: ткань
 Цвет плафона: белый



A7301PL-5PB

↑ 45 ∅ 70
 ♀ 5X40W | E14
 ♣ 14



A7301PL-8PB

↑ 45 ∅ 88
 ♀ 8X40W | E14
 ♣ 14





NEW
A4075LM-8BK

↑ 42 ∅ 89
∅ 8X40W | E14
⌀ 45 ∇ 10



NEW
A4075LM-5BK

↑ 42 ∅ 71
∅ 5X40W | E14
⌀ 45 ∇ 10



NEW
A4075AP-1BK

↑ 36 ↔ 15 ∇ 21
∅ 40W | E14

Fixture material: metal painted, metal plated
Fixture colour: black
Shade material: fabric
Shade colour: white

Материал арматуры: металл крашенный,
металл гальванизированный
Цвет арматуры: черный
Материал плафона: ткань
Цвет плафона: белый





A9310LM-8WG

↑ 34 ∅ 84
 ∅ 8X40W | E27
 ∅ 60 ∇ 10



A9310LM-5WG

↑ 40 ∅ 66
 ∅ 5X40W | E27
 ∅ 55 ∇ 10



A9310AP-1WG

↑ 45 ↔ 16 ↗ 26
 ∅ 40W | E27

Fixture material: metal painted
 Fixture colour: white gold
 Shade material: fabric
 Shade colour: cream

Материал арматуры: металл
 крашенный
 Цвет арматуры: бело-золотой
 Материал плафона: ткань
 Цвет плафона: кремовый





A4410LM-6-2SR

↑ 56 ∅ 57
 ♀ 6X40W/2X40W | E14/G9
 ⚡ 45 ∇ 12



A4410PL-3SR

↑ 36 ∅ 47
 ♀ 3X40W | E14
 ∇ 18



A4410PL-1SR

↑ 36 ∅ 20
 ♀ 40W | E14
 ∇ 15



A4410AP-1SR

↑ 35 ↔ 23 ∇ 33
 ♀ 40W | E14

Fixture material: metal plated
 Fixture colour: satin brass
 Shade material: glass
 Shade colour: clear

Материал арматуры: металл
 гальванизированный
 Цвет арматуры: матовая латунь
 Материал плафона: стекло
 Цвет плафона: прозрачный





A3579SP-3AB

↑ 32 ∅ 45
 ♀ 3X40W | E14
 ⚙ 100 ∇ 11



A3579AP-1AB

↑ 26 ↔ 18 ↗ 27
 ♀ 60W | E14



A3579PN-3AB

↑ 165 ∅ 45
 ♀ 3X40W | E14
 ⚙ 200

Fixture material: metal plated
 Fixture colour: antique bronze
 Shade material: fabric
 Shade colour: cream

Материал арматуры: металл
 гальванизированный
 Цвет арматуры: античная бронза
 Материал плафона: ткань
 Цвет плафона: кремовый



A3579LM-5AB

↑ 49 ∅ 64
 ♀ 5X40W | E14
 ⚙ 89 ∇ 11



A3579LT-3AB

↑ 55 ∅ 35
 ♀ 3X40W | E14
 ⚙ 180





A9518AP-1BA

↑ 27 ↔ 12 ↗ 23
 ♀ 40W | E27

Fixture material: metal painted
 Fixture colour: antique black
 Shade material: glass
 Shade colour: white

Материал арматуры: металл крашенный
 Цвет арматуры: античный черный
 Материал плафона: стекло
 Цвет плафона: белый



A9518LM-8BA

↑ 53 ∅ 85
 ♀ 8X40W | E27
 ⚙ 100 ∇ 15



A9518LM-5BA

↑ 53 ∅ 68
 ♀ 5X40W | E27
 ⚙ 100 ∇ 15



A3777LM-3-2AB

↑ 47 ∅ 77
 ♀ 3X40W/2X40W | E14/E27
 ⚙ 100 ∇ 10



A3777LM-6-2AB

↑ 37 ∅ 82
 ♀ 6X40W/2X40W | E14/E27
 ⚙ 100 ∇ 10



A3777AP-1AB

↑ 16 ↔ 15 ↗ 25
 ♀ 40W | E14



Fixture material: metal plated
 Fixture colour: antique bronze
 Shade material: glass
 Shade colour: white

Материал арматуры: металл гальванизированный
 Цвет арматуры: античная бронза
 Материал плафона: стекло
 Цвет плафона: белый

WINDSOR





A6905LM-3AB

↓ 45 ∅ 57
 ♀ 3X60W | E27
 ⚙ 50 ∇ 11



A6905AP-1AB

↓ 20 ↔ 20 ↗ 30
 ♀ 60W | E27



A6905LT-1AB

↓ 45 ↔ 20 ↗ 26
 ♀ 60W | E27
 ⚙ 230



A6905LM-5AB

↓ 42 ∅ 65
 ♀ 5X60W | E27
 ⚙ 50 ∇ 11



A6905SP-1AB

↓ 27 ∅ 41
 ♀ 60W | E27
 ⚙ 50 ∇ 11



Fixture material: metal plated
 Fixture colour: antique bronze
 Shade material: glass
 Shade colour: beige

Материал арматуры: металл
 гальванизированный
 Цвет арматуры: античная бронза
 Материал плафона: стекло
 Цвет плафона: бежевый



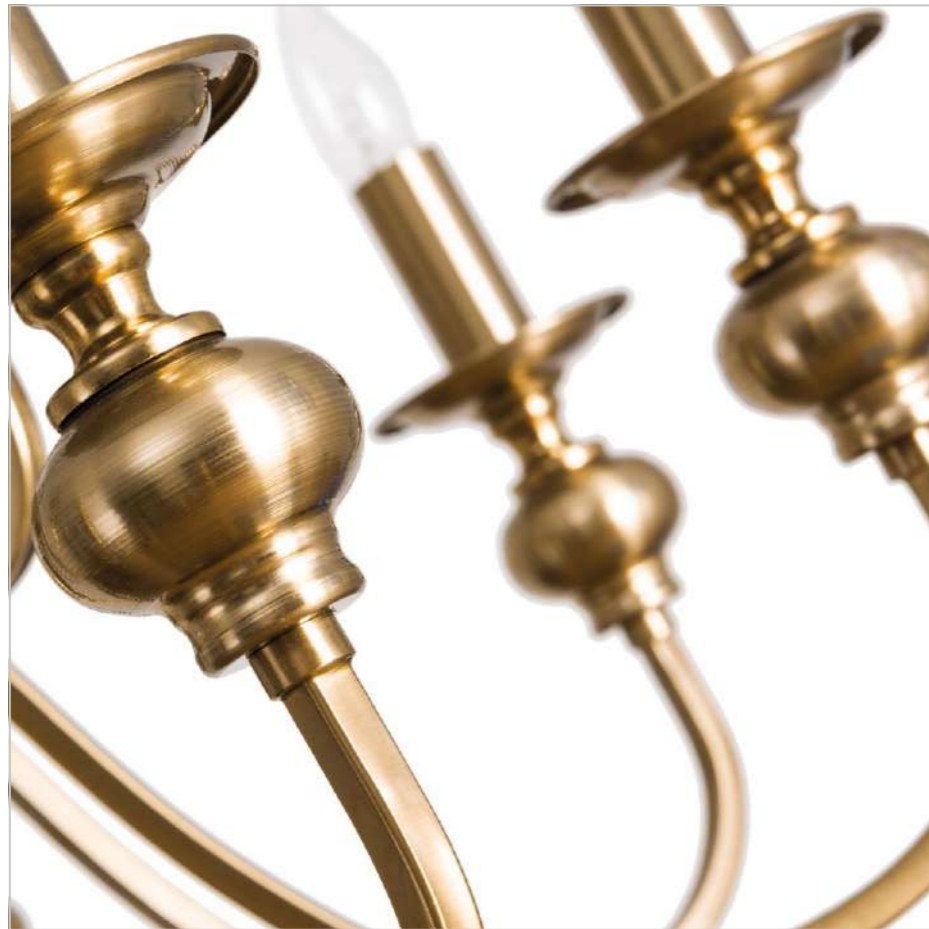

Fixture material: metal plated
 Fixture colour: polished brass

Материал арматуры: металл гальванизированный
 Цвет арматуры: полированная медь



A6097LM-12PB

↓ 55 ∅ 80
 ♀ 12X40W | E14
 ⚙ 60 ∇ 12



A6097LM-8PB

↓ 55 ∅ 80
 ♀ 8X40W | E14
 ⚙ 60 ∇ 12



A6097LM-6PB

↓ 50 ∅ 68
 ♀ 6X40W | E14
 ⚙ 60 ∇ 12



A6097LM-15PB

↓ 60 ∅ 93
 ♀ 15X40W | E14
 ⚙ 60 ∇ 12



A6097AP-1PB

↓ 23 ← 9 ↗ 21
 ♀ 40W | E14





Contempo

| СОВРЕМЕННЫЕ

все иллюстрации созданы инструментами нейросети
#Midjourney



A3144SP-1BK

↓ 30 ∅ 8
 ♀ 50W | GU10
 ⚙ 100 ∇ 7



A3145SP-1BK

↓ 30 ∅ 6
 ♀ 50W | GU10
 ⚙ 100 ∇ 7



A3147SP-1BK

↓ 25 ∅ 9
 ♀ 50W | GU10
 ⚙ 100 ∇ 7



A3162SP-1BK

↓ 33 ∅ 6
 ♀ 50W | GU10
 ⚙ 100 ∇ 7



A3143AP-2BK

↓ 18 ↔ 6 ↗ 9
 ♀ 2X50W | GU10

Fixture material: metal painted, plated
 Fixture colour: black / polished brass
 Shade material: metal plated, metal painted
 Shade colour: black / polished brass

Материал арматуры: металл крашенный, гальванизированный
 Цвет арматуры: черный / полированная медь
 Материал плафона: металл гальванизированный, металл крашенный
 Цвет плафона: черный / полированная медь

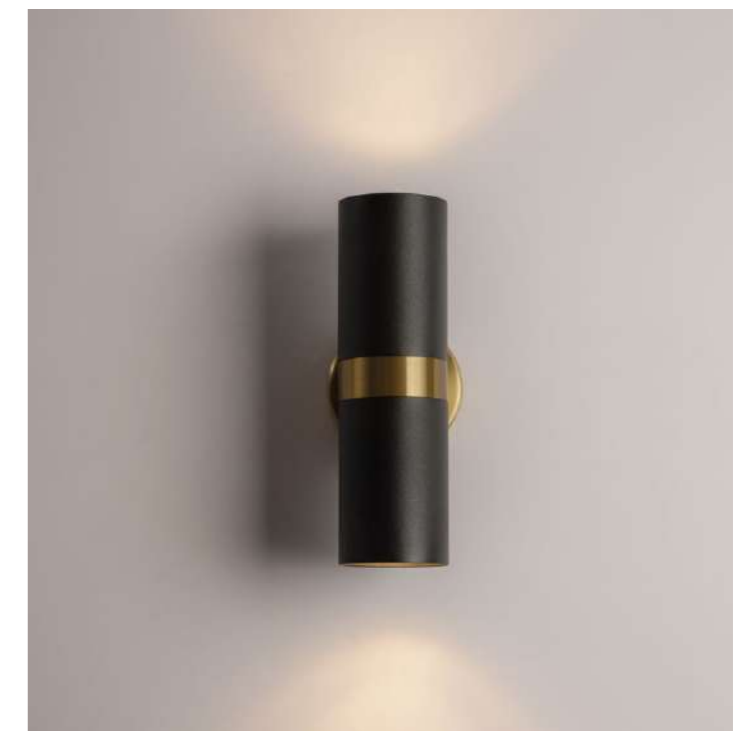



A3147SP-1PB
 ↓ 25 ∅9
 ♀ 50W | GU10
 ⌀ 100 ∇7



A3162SP-1PB
 ↓ 33 ∅6
 ♀ 50W | GU10
 ⌀ 100 ∇7



A3280SP-1BK
 ↓ 30 ∅6
 ♀ 50W | GU10
 ⌀ 100 ∇6



A3280SP-1WH
 ↓ 30 ∅6
 ♀ 50W | GU10
 ⌀ 100 ∇6



A3144SP-1PB
 ↓ 30 ∅8
 ♀ 50W | GU10
 ⌀ 100 ∇7



A3145SP-1PB
 ↓ 30 ∅6
 ♀ 50W | GU10
 ⌀ 100 ∇7



A3143AP-2PB
 ↓ 18 ↔ 6 ↗ 9
 ♀ 2X50W | GU10

Fixture material: metal painted, plated
 Fixture colour: black / polished brass
 Shade material: metal plated, metal painted
 Shade colour: black / polished brass
 Материал арматуры: металл крашеный, гальванизированный
 Цвет арматуры: черный / полированная медь
 Материал плафона: металл гальванизированный, металл крашеный
 Цвет плафона: черный / полированная медь

Fixture material: metal painted
 Fixture colour: black / white
 Shade material: metal painted
 Shade colour: black / white
 Материал арматуры: металл крашеный
 Цвет арматуры: черный / белый
 Материал плафона: металл крашеный
 Цвет плафона: черный / белый

SADR



SABIK



A6010SP-1BK

↓ 44 Ø6
 ♀ 7W | LED, 400LM,
 4000K, CRI/RA≥80
 ⚙ 100 ∇ 7



A6010SP-1SG

↓ 44 Ø6
 ♀ 7W | LED, 400LM,
 4000K, CRI/RA≥80
 ⚙ 100 ∇ 7



A6010SP-1CC

↓ 44 Ø6
 ♀ 7W | LED, 400LM,
 4000K, CRI/RA≥80
 ⚙ 100 ∇ 7



Fixture material: metal painted / metal plated
 Fixture colour: matt gold / black / chrome
 Shade material: metal painted, plastic /
 metal plated, plastic
 Shade colour: matt gold / black / chrome

Материал арматуры: металл крашенный /
 металл гальванизированный
 Цвет арматуры: матовое золото / черный / хром
 Материал плафона: металл крашенный, пластик /
 металл крашенный, гальванизированный /
 металл гальванизированный, пластик
 Цвет плафона: матовое золото / черный / хром



KRAZ

A2307SP-1WH

↓ 30 Ø6
 ♀ 10W | LED, 250LM,
 4000K, CRI/RA≥80
 ⚙ 100 ∇ 7



Fixture material: metal painted
 Fixture colour: white
 Shade material: metal painted
 Shade colour: white

Материал арматуры: металл крашенный
 Цвет арматуры: белый
 Материал плафона: металл крашенный,
 гальванизированный
 Цвет плафона: белый



A2308SP-1BK

↓ 30 Ø6
 ♀ 10W | LED, 250LM,
 4000K, CRI/RA≥80
 ⚙ 100 ∇ 7



Fixture material: metal painted
 Fixture colour: black
 Shade material: metal painted
 Shade colour: black

Материал арматуры: металл крашенный
 Цвет арматуры: черный
 Материал плафона: металл крашенный
 Цвет плафона: черный

SABIK





A3406SP-1BK

↓ 18 ∅ 36
♀ 40W | E27
⌘ 100 ∇ 10



A3407SP-1BK

↓ 30 ∅ 26
♀ 40W | E27
⌘ 100 ∇ 10



A3408SP-1BK

↓ 39 ∅ 19
♀ 40W | E27
⌘ 100 ∇ 10



A7039SP-1BK

↓ 20 ∅ 35
♀ 60W | E27
⌘ 100 ∇ 10



A7037SP-1BK

↓ 20 ∅ 22
♀ 60W | E27
⌘ 100 ∇ 10



A7038SP-1BK

↓ 20 ∅ 23
♀ 60W | E27
⌘ 100 ∇ 10



Fixture material: metal painted
Fixture colour: black
Shade material: metal painted
Shade colour: black

Материал арматуры: металл
крашенный
Цвет арматуры: черный
Материал плафона: металл
крашенный
Цвет плафона: черный



NEW

A7046SP-1BK

↑ 31 ∅ 37
 ♀ 60W | E27
 ⚙ 90 ∇ 10



NEW

A7046SP-1PB

↑ 31 ∅ 37
 ♀ 60W | E27
 ⚙ 90 ∇ 10



Fixture material: metal painted / metal plated
 Fixture colour: polished brass / black
 Shade material: metal plated / metal painted
 Shade colour: polished brass / black

Материал арматуры: металл крашенный / металл гальванизированный
 Цвет арматуры: полированная медь / черный
 Материал плафона: металл гальванизированный / металл крашенный
 Цвет плафона: полированная медь / черный



PANDORA

A9183SP-1BK

↑ 33 ∅ 37
 ♀ 60W | E27
 ⚙ 45 ∇ 14



Fixture material: metal painted
 Fixture colour: black
 Shade material: metal painted
 Shade colour: black

Материал арматуры: металл крашенный
 Цвет арматуры: черный
 Материал плафона: металл крашенный
 Цвет плафона: черный

A4245SP-1BK

↑ 21 ∅ 21
 ♀ 60W | E27
 ⚙ 100 ∇ 12



A4248SP-1BK

↑ 21 ∅ 16
 ♀ 60W | E27
 ⚙ 100 ∇ 12



A4249SP-1BK

↑ 27 ∅ 40
 ♀ 60W | E27
 ⚙ 100 ∇ 12



Fixture material: metal painted
 Fixture colour: black
 Shade material: metal painted
 Shade colour: black

Материал арматуры: металл крашенный
 Цвет арматуры: черный
 Материал плафона: металл крашенный
 Цвет плафона: черный

EURICA





A5213SP-1WG

↓ 27 ∅ 40
 ♀ 75W | E27
 ⚡ 70 ∇ 10



A5213SP-1BR

↓ 27 ∅ 40
 ♀ 75W | E27
 ⚡ 70 ∇ 10



A5213AP-2WG

↓ 23 ↔ 11 ∇ 36
 ♀ 2X40W | E14



A5215PL-4WG

↓ 25 ↔ 12 ∇ 80
 ♀ 4X40W | E14
 ∇ 9



A5215PL-4BR

↓ 25 ↔ 12 ∇ 80
 ♀ 4X40W | E14
 ∇ 9



A5213AP-1WG

↓ 18 ↔ 11 ∇ 21
 ♀ 40W | E14



A5213AP-2BR

↓ 23 ↔ 11 ∇ 36
 ♀ 2X40W | E14



A5213AP-1BR

↓ 18 ↔ 11 ∇ 21
 ♀ 40W | E14



Fixture material: metal painted
 Fixture colour: white gold / brown
 Shade material: metal painted
 Shade colour: white gold / brown

Материал арматуры: металл крашенный
 Цвет арматуры: бело-золотой / коричневый
 Материал плафона: металл крашенный
 Цвет плафона: бело-золотой / коричневый





A7033SP-1BK

↓ 18 ∅ 22
 ♀ 60W | E27
 ⌀ 120 ∇ 10



A7041SP-1BK

↓ 26 ∅ 32
 ♀ 60W | E27
 ⌀ 120 ∇ 10



A7033AP-1BK

↓ 20 ↔ 18 ↗ 28
 ♀ 60W | E27

A7033PN-1BK

↓ 163 ↔ 22 ↗ 30
 ♀ 60W | E27
 ∅ 180

Fixture material: metal painted
 Fixture colour: black
 Shade material: metal plated
 Shade colour: satin brass
 Материал арматуры: металл крашенный
 Цвет арматуры: черный
 Материал плафона: металл гальванизированный
 Цвет плафона: матовая латунь



A7029PL-9BK

↓ 67 ∅ 182
 ♀ 3X60W/6X40W | E27/G9
 ∇ 17



A7029AP-1BK

↓ 21 ↔ 15 ↗ 19
 ♀ 60W | E27



A7029PL-3BK

↓ 67 ↔ 15 ↗ 131
 ♀ 60W/2X40W | E27/G9
 ∇ 6

Fixture material: metal painted
 Fixture colour: black
 Shade material: metal plated, glass
 Shade colour: polished brass; white
 Материал арматуры: металл крашенный
 Цвет арматуры: черный
 Материал плафона: металл, стекло
 Цвет плафона: полированная медь; белый



JACOB



A7620AP-1AB

↓ 33 ↔ 20 ↗ 28
 ♀ 60W | E27



A7620SP-1AB

↓ 31 ∅ 20
 ♀ 60W | E27
 ⚙ 150 ∇ 10



A7625SP-1AB

↓ 38 ∅ 25
 ♀ 60W | E27
 ⚙ 150 ∇ 10



A7630SP-1AB

↓ 43 ∅ 30
 ♀ 60W | E27
 ⚙ 150 ∇ 10



Fixture material: metal plated
 Fixture colour: antique bronze
 Shade material: metal plated, glass
 Shade colour: clear

Материал арматуры: металл гальванизированный
 Цвет арматуры: античная бронза
 Материал плафона: металл, стекло
 Цвет плафона: прозрачный



NEW

A7045PL-6BK

↓ 26 ∅ 68
 ♀ 6X40W | E14
 ∇ 15



Fixture material: metal plated / metal painted, metal plated
 Fixture colour: antique bronze / black
 Shade material: metal plated, glass
 Shade colour: clear



NEW

A7045PL-8BK

↓ 26 ∅ 75
 ♀ 8X40W | E14
 ∇ 15



Материал арматуры: металл гальванизированный / металл крашенный, металл гальванизированный
 Цвет арматуры: античная бронза / черный
 Материал плафона: металл, стекло
 Цвет плафона: прозрачный



NEW

A7045AP-1BK

↓ 20 ↔ 14 ↗ 20
 ♀ 40W | E14





A7780SP-7AB

↓ 27 ↔ 65 ↗ 76
 ∅ 7X40W | G9
 ⌀ 120 ∇ 12



A7780SP-5AB

↓ 27 ∅ 72
 ∅ 5X40W | G9
 ⌀ 120 ∇ 12



A7780SP-9AB

↓ 26 ↔ 65 ↗ 100
 ∅ 9X40W | G9
 ⌀ 120 ∇ 15



A7780AP-2AB

↓ 29 ↔ 15 ↗ 23
 ∅ 2X40W | G9



A7780AP-1AB

↓ 23 ↔ 15 ↗ 25
 ∅ 40W | G9



Fixture material: metal plated
 Fixture colour: antique bronze
 Shade material: glass
 Shade colour: clear

Материал арматуры: металл
 гальванизированный
 Цвет арматуры: античная бронза
 Материал плафона: стекло
 Цвет плафона: прозрачный





Fixture material: metal painted
 Fixture colour: gold / black
 Shade material: glass
 Shade colour: clear

Материал арматуры: металл крашенный
 Цвет арматуры: золото / черный
 Материал плафона: стекло
 Цвет плафона: прозрачный



A7790SP-8GO

↑ 38 ↔ 34 ↗ 80
 ♀ 8X40W | G9
 ⌀ 110 ∇ 8



A7790AP-1GO

↑ 15 ↔ 15 ↗ 18
 ♀ 40W | G9



A7790SP-10GO

↑ 27 ↔ 53 ↗ 76
 ♀ 10X40W | G9
 ⌀ 110 ∇ 8



A7790SP-24GO

↑ 32 ↔ 108 ↗ 120
 ♀ 24X40W | G9
 ⌀ 110 ∇ 8



A7790SP-15GO

↑ 32 ∅ 98
 ♀ 15X40W | G9
 ⌀ 110 ∇ 8



A471201

↑ 4 ∅ 12

single canopy replacement available –
 допускается замена на крепление
 на одной потолочной чашке



A7790AP-1BK

↑ 15 ↔ 15 ↗ 18
 ∅ 40W | G9



A7790SP-10BK

↑ 27 ↔ 53 ↗ 76
 ∅ 10X40W | G9
 ∅ 110 ∇ 8



A471206

↑ 4 ∅ 12

single canopy replacement available —
 допускается замена на крепление
 на одной потолочной чашке



A7790SP-15BK

↑ 32 ∅ 98
 ∅ 15X40W | G9
 ∅ 110 ∇ 8



A7790SP-24BK

↑ 32 ↔ 108 ↗ 120
 ∅ 24X40W | G9
 ∅ 110 ∇ 8



A7790SP-8BK

↑ 38 ↔ 34 ↗ 80
 ∅ 8X40W | G9
 ∅ 110 ∇ 8





A1369PL-7SG

↓ 37 ∅ 63
 ♀ 7X40W | G9
 ∇ 15



adjustable central rod
 — укорачиваемый
 центральный шток

A1369SP-15SG

↓ 33 ∅ 95
 ♀ 15X40W | G9
 ∅ 20/30/50 ∇ 15



adjustable central rod
 — укорачиваемый
 центральный шток

A1369SP-10SG

↓ 28 ∅ 78
 ♀ 10X40W | G9
 ∅ 20/30/50 ∇ 15



Fixture material: metal painted
 Fixture colour: matt gold
 Shade material: glass
 Shade colour: white

Материал арматуры: металл
 крашенный
 Цвет арматуры: матовое золото
 Материал плафона: стекло
 Цвет плафона: белый



Fixture material: metal painted, plated / metal plated
 Fixture colour: black / polished brass
 Shade material: glass
 Shade colour: white

Материал арматуры: металл крашенный, гальванизированный / металл гальванизированный
 Цвет арматуры: черный / полированная медь
 Материал плафона: стекло
 Цвет плафона: белый



A2224AP-1BK

↑ 23 ↔ 15 ↗ 23
 ♀ 40W | E14
 ∇ 12



A2224PL-6BK

↑ 34 ∅ 85
 ♀ 6X40W | E14
 ∇ 12



A2224PL-8BK

↑ 39 ∅ 93
 ♀ 8X40W | E14
 ∇ 12



NEW

A2224SP-8BK

↑ 34 ↔ 150
 ♀ 8X40W | E14
 ⚙ 100 ∇ 40X4



NEW

A2224PL-1PB

↑ 18 ∅ 15
 ♀ 40W | E14
 ∇ 10



NEW

A2224SP-6BK

↑ 34 ∅ 65
 ♀ 6X40W | E14
 ⚙ 100 ∇ 10



NEW

A2224PL-1BK

↑ 18 ∅ 15
 ♀ 40W | E14
 ∇ 10



NEW

A2224SP-3BK

↑ 54 ∅ 35
 ♀ 3X40W | E14
 ⚙ 150 ∇ 10



NEW

A2224PN-2BK

↑ 165 ↔ 25 ↗ 35
 ♀ 2X40W | E14
 ∇ 180



A1664AP-1GO

↓ 24 ↔ 13 ↗ 18
 ♀ 40W | E14
 ∇ 10



adjustable central rod
 — укорачиваемый
 центральный штوك

A1664SP-12GO

↓ 36 ∅ 90
 ♀ 12X40W | E14
 ∅ 50-100 ∇ 12



adjustable central rod
 — укорачиваемый
 центральный штوك

A1664SP-25GO

↓ 38 ∅ 100
 ♀ 25X40W | E14
 ∅ 100 ∇ 15



adjustable central rod
 — укорачиваемый
 центральный штوك

A1664SP-15CC

↓ 85 ∅ 130
 ♀ 15X40W | E14
 ∅ 30-60 ∇ 12



adjustable central rod
 — укорачиваемый
 центральный штوك

A1664SP-12CC

↓ 36 ∅ 90
 ♀ 12X40W | E14
 ∅ 50-100 ∇ 12



A1664AP-1CC

↓ 24 ↔ 13 ↗ 18
 ♀ 40W | E14
 ∇ 10



A1664SP-25CC

↓ 38 ∅ 100
 ♀ 25X40W | E14
 ∅ 100 ∇ 15



Fixture material: metal painted / metal plated
 Fixture colour: black / chrome / gold
 Shade material: glass
 Shade colour: amber / clear / white

Материал арматуры: металл крашенный / металл гальванизированный
 Цвет арматуры: черный / хром / золото
 Материал плафона: стекло
 Цвет плафона: янтарный / прозрачный / белый



A1664SP-25BK

↑ 38 ∅ 100
 ♀ 25X40W | E14
 ⌘ 100 ∇ 15



A1664AP-1BK

↑ 24 ↔ 13 ↗ 18
 ♀ 40W | E14
 ∇ 10



adjustable central rod
 — укорачиваемый
 центральный штوك

A1664SP-15BK

↑ 85 ∅ 130
 ♀ 15X40W | E14
 ⌘ 30-60 ∇ 12



adjustable central rod
 — укорачиваемый
 центральный штوك

A1664SP-12BK

↑ 36 ∅ 90
 ♀ 12X40W | E14
 ⌘ 50-100 ∇ 12





A1915SP-1CC

↓ 28 ∅ 15
 ♀ 40W | E14
 ⌘ 150 ∇ 8



A1920SP-1CC

↓ 32 ∅ 20
 ♀ 60W | E27
 ⌘ 150 ∇ 10



A1925SP-1CC

↓ 37 ∅ 25
 ♀ 60W | E27
 ⌘ 150 ∇ 10



A1930SP-1CC

↓ 43 ∅ 30
 ♀ 60W | E27
 ⌘ 150 ∇ 10



A1940SP-1CC

↓ 53 ∅ 40
 ♀ 60W | E27
 ⌘ 150 ∇ 10



A1915SP-1AB

↓ 28 ∅ 15
 ♀ 40W | E14
 ⌘ 150 ∇ 8



A1925SP-1AB

↓ 37 ∅ 25
 ♀ 60W | E27
 ⌘ 150 ∇ 10



A1920SP-1AB

↓ 32 ∅ 20
 ♀ 60W | E27
 ⌘ 150 ∇ 10



A1930SP-1AB

↓ 43 ∅ 30
 ♀ 60W | E27
 ⌘ 150 ∇ 10



A1940SP-1AB

↓ 53 ∅ 40
 ♀ 60W | E27
 ⌘ 150 ∇ 12



Fixture material: metal plated / metal painted
 Fixture colour: polished brass / chrome / gold / antique bronze / satin silver
 Shade material: glass
 Shade colour: white / clear

Материал арматуры: металл
 гальванизированный / металл крашенный
 Цвет арматуры: полированная медь / хром / золото / античная бронза / матовое серебро
 Материал плафона: стекло
 Цвет плафона: белый / прозрачный

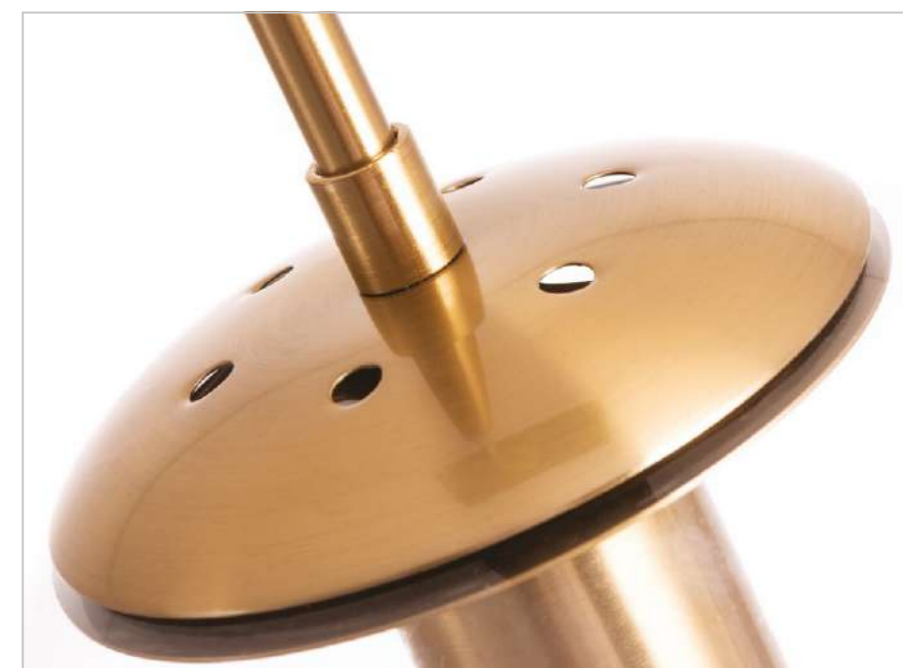



A1900SP-8AB

↑ 300 ∅ 58
 ♀ 8X40W | E14
 ∇ 45



Fixture material: metal plated / metal painted
 Fixture colour: polished brass / chrome / gold / antique bronze / satin silver
 Shade material: glass
 Shade colour: white / clear

Материал арматуры: металл гальванизированный / металл крашенный
 Цвет арматуры: полированная медь / хром / золото / античная бронза / матовое серебро
 Материал плафона: стекло
 Цвет плафона: белый / прозрачный



A1915SP-3AB

↑ 28 ↔ 15 ↗ 79
 ♀ 3X40W | E14
 ∅ 100 ∇ 10



VOLARE



A1915SP-1GO

↑ 28 ∅ 15
 ♀ 40W | E14
 ∅ 150 ∇ 8



Fixture material: metal plated
 Fixture colour: antique bronze
 Shade material: glass
 Shade colour: clear

Материал арматуры: металл гальванизированный
 Цвет арматуры: античная бронза
 Материал плафона: стекло
 Цвет плафона: прозрачный

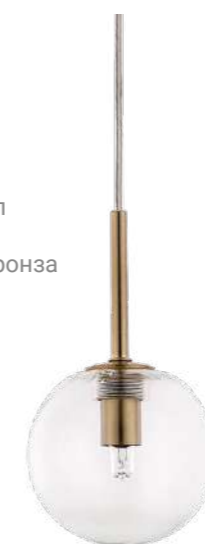

A7710SP-1AB

↑ 20 ∅ 10
 ♀ 40W | G9
 ∅ 150 ∇ 8



A7715SP-1AB

↑ 26 ∅ 15
 ♀ 40W | G9
 ∅ 150 ∇ 8



A7720SP-1AB

↑ 33 ∅ 20
 ♀ 40W | G9
 ∅ 150 ∇ 10



A1920SP-1GO

↑ 32 ∅ 20
 ♀ 60W | E27
 ∅ 150 ∇ 10



A1925SP-1GO

↑ 37 ∅ 25
 ♀ 60W | E27
 ∅ 150 ∇ 10



CAMERON



A1565SP-1PB

↓ 28 ∅ 15
 ♀ 60W | E14
 ⚙ 150 ∇ 8



A1561SP-1PB

↓ 37 ∅ 25
 ♀ 60W | E27
 ⚙ 150 ∇ 10



A1563SP-1PB

↓ 30 ∅ 20
 ♀ 60W | E27
 ⚙ 150 ∇ 10



A1564SP-1PB

↓ 53 ∅ 40
 ♀ 60W | E27
 ⚙ 150 ∇ 10



A1562SP-1PB

↓ 42 ∅ 30
 ♀ 60W | E27
 ⚙ 150 ∇ 10



Fixture material: metal plated / metal painted
 Fixture colour: chrome / antique bronze / satin silver / polished brass / gold
 Shade material: glass
 Shade colour: white / clear

Материал арматуры: металл гальванизированный / металл крашенный
 Цвет арматуры: хром / античная бронза / матовое серебро / полированная медь / золото
 Материал плафона: стекло
 Цвет плафона: белый / прозрачный



A1565SP-1CC

↓ 28 ∅ 15
 ♀ 60W | E14
 ⚙ 150 ∇ 8



A1563SP-1CC

↓ 30 ∅ 20
 ♀ 60W | E27
 ⚙ 150 ∇ 10



A1561SP-1CC

↓ 37 ∅ 25
 ♀ 60W | E27
 ⚙ 150 ∇ 10



A1562SP-1CC

↓ 42 ∅ 30
 ♀ 60W | E27
 ⚙ 150 ∇ 10



A1564SP-1CC

↓ 53 ∅ 40
 ♀ 60W | E27
 ⚙ 150 ∇ 12





A1921PN-1CC

↓ 152 ∅ 25
 ♀ 40W | E27
 ☿ 200



A1924SP-1CC

↓ 48 ↔ 15 ↗ 20
 ♀ 40W | E14
 ☿ 150 ☿ 10



A1923SP-1CC

↓ 53 ↔ 20 ↗ 25
 ♀ 60W | E27
 ☿ 150 ☿ 10



A1921SP-1CC

↓ 65 ↔ 25 ↗ 32
 ♀ 40W | E27
 ☿ 150 ☿ 10



A1922SP-1CC

↓ 72 ↔ 30 ↗ 39
 ♀ 40W | E27
 ☿ 150 ☿ 10



A1921AP-1CC

↓ 22 ↔ 20 ↗ 24
 ♀ 40W | E27
 ☿ 10



A1924AP-1CC

↓ 19 ↔ 15 ↗ 23
 ♀ 40W | E14
 ☿ 10



A1921LT-1CC

↓ 30 ∅ 20
 ♀ 40W | E27
 ☿ 190





A1921LT-1AB

↓ 30 ∅ 20
♀ 40W | E27
♣ 180



A1921PN-1AB

↓ 152 ∅ 25
♀ 40W | E27
♣ 200



Fixture material: metal plated
Fixture colour: chrome / antique bronze
Shade material: glass
Shade colour: white

Материал арматуры: металл гальванизированный
Цвет арматуры: хром / античная бронза
Материал плафона: стекло
Цвет плафона: белый



A1924SP-1AB

↓ 48 ↔ 15 ↗ 20
♀ 40W | E14
♣ 150 ♣ 10



A1923SP-1AB

↓ 53 ↔ 20 ↗ 25
♀ 60W | E27
♣ 150 ♣ 10



A1921SP-1AB

↓ 65 ↔ 25 ↗ 32
♀ 40W | E27
♣ 150 ♣ 10



A1922SP-1AB

↓ 72 ↔ 30 ↗ 39
♀ 40W | E27
♣ 150 ♣ 10



Fixture material: metal plated
Fixture colour: chrome / antique bronze
Shade material: glass
Shade colour: white



A1921AP-1AB

↓ 22 ↔ 20 ↗ 24
♀ 40W | E27



A1924AP-1AB

↓ 19 ↔ 15 ↗ 23
♀ 40W | E14



Материал арматуры: металл гальванизированный
Цвет арматуры: хром / античная бронза
Материал плафона: стекло
Цвет плафона: белый



Fixture material: metal plated
 Fixture colour: antique bronze
 Shade material: glass
 Shade colour: white



NEW
A7745SP-3AB

↓ 47 ↔ 13 ↗ 60
 ♀ 3X40W | E14
 ⚙ 100 ∇ 43X5

Материал арматуры: металл
 гальванизированный
 Цвет арматуры: античная
 бронза
 Материал плафона: стекло
 Цвет плафона: белый



A7765AP-1AB

↓ 47 ↔ 20 ↗ 21
 ♀ 40W | E14
 ∇ 10



A7745LT-1AB

↓ 50 ↔ 15 ↗ 22
 ♀ 40W | E14
 ⚙ 150



A7746SP-1AB

↓ 51 ↔ 20 ↗ 25
 ♀ 60W | E27
 ⚙ 150 ∇ 10



A7745SP-1AB

↓ 41 ↔ 15 ↗ 20
 ♀ 40W | E14
 ⚙ 150 ∇ 10



NEW
A7745SP-2AB

↓ 50 ↔ 15 ↗ 20
 ♀ 2X40W | E14
 ⚙ 150 ∇ 10



NEW
A7741AP-1AB

↓ 31 ↔ 19 ↗ 26
 ♀ 40W | E14





A7765SP-1AB

↓ 48 ↔ 20 ↗ 31
 ♀ 60W | E27
 ⚙ 150 ∇ 10



A7764SP-1AB

↓ 37 ↔ 15 ↗ 25
 ♀ 40W | E14
 ⚙ 150 ∇ 10



A7741SP-1AB

↓ 32 ↔ 15 ↗ 30
 ♀ 40W | E14
 ⚙ 150 ∇ 10



A7742SP-1AB

↓ 42 ↔ 20 ↗ 40
 ♀ 60W | E27
 ⚙ 150 ∇ 10



Fixture material: metal plated
 Fixture colour: antique bronze
 Shade material: glass
 Shade colour: white

Материал арматуры: металл
 гальванизированный
 Цвет арматуры: античная бронза
 Материал плафона: стекло
 Цвет плафона: белый



A3325SP-1PB

↓ 42 ∅ 25
 ♀ 60W | E27
 ⚙ 150 ∇ 10



A3330SP-1PB

↓ 48 ∅ 30
 ♀ 60W | E27
 ⚙ 150 ∇ 10



A3315SP-1PB

↓ 30 ∅ 15
 ♀ 40W | E14
 ⚙ 150 ∇ 8



A3320SP-1PB

↓ 36 ∅ 20
 ♀ 60W | E27
 ⚙ 150 ∇ 10



Fixture material: metal plated
 Fixture colour: polished brass
 Shade material: glass
 Shade colour: white

Материал арматуры: металл
 гальванизированный
 Цвет арматуры: полированная медь
 Материал плафона: стекло
 Цвет плафона: белый

BOLLA-SOLA





Fixture material:
 metal plated
 Fixture colour:
 antique bronze
 Shade material: glass
 Shade colour: white
 Материал
 арматуры: металл
 гальванизированный
 Цвет арматуры:
 античная бронза
 Материал плафона:
 стекло
 Цвет плафона: белый



A3988SP-20AB

↓ 26 ∅ 60
 ♀ 20X25W | G9
 ⚙ 80 ∇ 12



A3988SP-25AB

↓ 26 ∅ 72
 ♀ 25X25W | G9
 ⚙ 85 ∇ 15



adjustable central rod
 – укорачиваемый
 центральный штوك

A3988SP-12AB

↓ 28 ↔ 28 ↗ 72
 ♀ 12X25W | G9
 ⚙ 20-50 ∇ 10



adjustable central rod
 – укорачиваемый
 центральный штوك

A3988SP-16AB

↓ 28 ↔ 28 ↗ 92
 ♀ 16X25W | G9
 ⚙ 20-50 ∇ 10



A3988AP-2AB

↓ 29 ↔ 12 ↗ 32
 ♀ 2X25W | G9



A3989AP-1AB

↓ 14 ↔ 10 ↗ 13
 ♀ 25W | G9





A1582SP-1CC

↓ 30 ∅ 30
 ♀ 40W | E27
 ⚙ 150 ∇ 10



A1583SP-1CC

↓ 54 ∅ 40
 ♀ 60W | E27
 ⚙ 150 ∇ 10



A1581SP-1CC

↓ 25 ∅ 25
 ♀ 40W | E27
 ⚙ 150 ∇ 10



A7760SP-8CC

↓ 300 ∅ 63
 ♀ 8X40W | E27
 ∇ 45



A7761SP-1CC

↓ 29 ∅ 18
 ♀ 60W | E27
 ⚙ 150 ∇ 10



A7762SP-1CC

↓ 34 ∅ 23
 ♀ 60W | E27
 ⚙ 150 ∇ 10



A7763SP-1CC

↓ 40 ∅ 28
 ♀ 60W | E27
 ⚙ 150 ∇ 10



Fixture material: metal plated
 Fixture colour: chrome
 Shade material: glass
 Shade colour: chrome, clear

Материал арматуры: металл
 гальванизированный
 Цвет арматуры: хром
 Материал плафона: стекло
 Цвет плафона: хром, прозрачный



Fixture material: metal plated
 Fixture colour: chrome
 Shade material: glass
 Shade colour: chrome, clear

Материал арматуры: металл
 гальванизированный
 Цвет арматуры: хром
 Материал плафона: стекло
 Цвет плафона: хром, прозрачный

WAVE





A7961SP-1CC

↓ 32 ∅ 20
 ♀ 60W | E27
 ⚙ 150 ∇ 10



A7962SP-1CC

↓ 37 ∅ 25
 ♀ 60W | E27
 ⚙ 150 ∇ 10



A7963SP-1CC

↓ 42 ∅ 30
 ♀ 60W | E27
 ⚙ 150 ∇ 10



A7964SP-1CC

↓ 54 ∅ 40
 ♀ 60W | E27
 ⚙ 150 ∇ 10



Fixture material: metal plated
 Fixture colour: chrome
 Shade material: glass
 Shade colour: chrome, clear

Материал арматуры: металл гальванизированный
 Цвет арматуры: хром
 Материал плафона: стекло
 Цвет плафона: хром, прозрачный



A7961SP-1GO

↓ 32 ∅ 20
 ♀ 60W | E27
 ⚙ 150 ∇ 10



A7962SP-1GO

↓ 37 ∅ 25
 ♀ 60W | E27
 ⚙ 150 ∇ 10



A7963SP-1GO

↓ 42 ∅ 30
 ♀ 60W | E27
 ⚙ 150 ∇ 10



A7964SP-1GO

↓ 54 ∅ 40
 ♀ 60W | E27
 ⚙ 150 ∇ 10



JUPITER GOLD



Fixture material: metal plated
 Fixture colour: gold
 Shade material: glass
 Shade colour: gold, clear

Материал арматуры: металл гальванизированный
 Цвет арматуры: золото
 Материал плафона: стекло
 Цвет плафона: золото, прозрачный

A7961SP-1RB

↑ 32 ∅ 20
 ♀ 60W | E27
 ⌀ 150 ∇ 10



A7962SP-1RB

↑ 37 ∅ 25
 ♀ 60W | E27
 ⌀ 150 ∇ 10



A7963SP-1RB

↑ 42 ∅ 30
 ♀ 60W | E27
 ⌀ 150 ∇ 10



A7964SP-1RB

↑ 54 ∅ 40
 ♀ 60W | E27
 ⌀ 150 ∇ 10



Fixture material: metal plated
 Fixture colour: red bronze
 Shade material: glass
 Shade colour: red bronze, clear

Материал арматуры: металл
 гальванизированный
 Цвет арматуры: красная бронза
 Материал плафона: стекло
 Цвет плафона: красная бронза,
 прозрачный



NEW

A2243SP-9PB

↑ 30 ↔ 106 ↗ 25
 ♀ 9X33W | G9
 ⌀ 100



NEW

A2243PN-6PB

↑ 165 ∅ 29
 ♀ 6X33W | G9
 ∅ 200

Fixture material: metal painted, plated
 Fixture colour: polished brass
 Shade material: glass
 Shade colour: amber

Материал арматуры: металл
 крашенный, гальванизированный
 Цвет арматуры: полированная медь
 Материал плафона: стекло
 Цвет плафона: янтарный



NEW

A2243PL-3PB

↑ 22 ↔ 24 ↗ 42
 ♀ 3X33W | G9
 ∅ 10



NEW

A2243LT-4PB

↑ 52 ∅ 24
 ♀ 4X33W | G9
 ∅ 180

GEMINI





A9915SP-1BK

↓ 23 ∅ 15
♀ 60W | E14
⌘ 150 ∇ 11



A9920SP-1BK

↓ 30 ∅ 20
♀ 60W | E14
⌘ 150 ∇ 11



A9915SP-1CC

↓ 23 ∅ 15
♀ 60W | E14
⌘ 150 ∇ 11



A9920SP-1CC

↓ 30 ∅ 20
♀ 60W | E14
⌘ 150 ∇ 11



A9915SP-1PB

↓ 23 ∅ 15
♀ 60W | E14
⌘ 150 ∇ 11



A9920SP-1PB

↓ 30 ∅ 20
♀ 60W | E14
⌘ 150 ∇ 11



Fixture material: metal painted / metal plated
Fixture colour: black / chrome / polished brass
Shade material: glass
Shade colour: smoky / clear / amber

Материал арматуры: металл крашенный / металл гальванизированный
Цвет арматуры: черный / хром / полированная медь
Материал плафона: стекло
Цвет плафона: дымчатый / прозрачный / янтарный



A4285SP-1AM

↓ 17 ∅ 20
♀ 40W | E27
⌘ 100 ∇ 12



Moist glass –
«мокрое» стекло



A4285SP-1AC

↓ 17 ∅ 20
♀ 40W | E27
⌘ 100 ∇ 12



Moist glass –
«мокрое» стекло

A4285SP-1SM

↓ 17 ∅ 20
♀ 40W | E27
⌘ 100 ∇ 12



Moist glass –
«мокрое» стекло



SPLENDIDO



Fixture material: metal painted
Fixture colour: black
Shade material: glass
Shade colour: antique copper /
amber / smoky

Материал арматуры: металл
крашенный
Цвет арматуры: черный
Материал плафона: стекло
Цвет плафона: античная медь /
янтарный / дымчатый



A1992SP-1PB

↑ 36 ∅ 29
 ♀ 60W | E27
 ⌘ 150 ∟ 10



Fixture material: metal plated
 Fixture colour: polished brass
 Shade material: glass
 Shade colour: smoky
 Материал арматуры: металл
 гальванизированный
 Цвет арматуры: полированная медь
 Материал плафона: стекло
 Цвет плафона: дымчатый



A7015SP-1BK

↑ 38 ∅ 15
 ♀ 60W | E14
 ⌘ 82 ∟ 10



Fixture material: metal painted
 Fixture colour: black
 Shade material: glass
 Shade colour: amber

Материал арматуры: металл
 крашенный
 Цвет арматуры: черный
 Материал плафона: стекло
 Цвет плафона: янтарный



A7015AP-1BK

↑ 30 ↔ 15 ∟ 21
 ♀ 60W | E14



PAIO





A6170SP-1GO

↓ 26 ∅ 20
♀ 60W | E27
▽ 10

Textile cord -
Текстильный шнур



A6170PL-1GO

↓ 19 ∅ 28
♀ 60W | E27
▽ 12



A6170AP-1GO

↓ 16 ↔ 16 ↗ 16
♀ 40W | E27
▽ 10



Fixture material: metal painted
Fixture colour: gold
Shade material: glass
Shade colour: smoky

Материал арматуры: металл крашенный
Цвет арматуры: золото
Материал плафона: стекло
Цвет плафона: дымчатый



A1902SP-1WH

↓ 23 ∅ 15
♀ 60W | E27
♀ 150 ▽ 8



A1902SP-1BK

↓ 23 ∅ 15
♀ 60W | E27
♀ 150 ▽ 8



A1903SP-1BK

↓ 35 ∅ 20
♀ 60W | E27
♀ 150 ▽ 8



A1903SP-1WH

↓ 35 ∅ 20
♀ 60W | E27
♀ 150 ▽ 8



Fixture material: metal painting
Fixture colour: white / black
Shade material: glass
Shade colour: white / smoky

Материал арматуры: металл крашенный
Цвет арматуры: белый / черный
Материал плафона: стекло
Цвет плафона: белый / дымчатый

ARWEN





NEW
A2231PL-5PB

↑ 30 ∅ 47
♀ 5X40W | E14
▽ 42



NEW
A2231SP-9PB

↑ 300 ∅ 50
♀ 8X40W | E14
▽ 46



NEW
A2231SP-1PB

↑ 20 ∅ 15
♀ 40W | E14
⌘ 150 ▽ 10



NEW
A2232SP-1PB

↑ 26 ∅ 13
♀ 40W | E14
⌘ 150 ▽ 10



NEW
A2234SP-1PB

↑ 25 ∅ 13
♀ 40W | E14
⌘ 150 ▽ 10



Fixture material: metal plated
Fixture colour: polished brass
Shade material: glass
Shade colour: smoky

Материал арматуры: металл
гальванизированный
Цвет арматуры: полированная медь
Материал плафона: стекло
Цвет плафона: дымчатый



A7766SP-1AB

↓ 27 ∅ 18
 ♀ 10W | LED, 600LM,
 3000K, CRI/RA≥80
 ⚙ 150 ∇ 10



A7766SP-1BC

↓ 27 ∅ 18
 ♀ 10W | LED, 600LM,
 3000K, CRI/RA≥80
 ⚙ 150 ∇ 10



A7767SP-1BC

↓ 16 ∅ 30
 ♀ 10W | LED, 600LM,
 3000K, CRI/RA≥80
 ⚙ 150 ∇ 10



A7768SP-1BC

↓ 30 ∅ 30
 ♀ 10W | LED, 600LM,
 3000K, CRI/RA≥80
 ⚙ 150 ∇ 10



A7769SP-1BC

↓ 30 ∅ 17
 ♀ 10W | LED, 600LM,
 3000K, CRI/RA≥80
 ⚙ 150 ∇ 10



Textile cord -
 Текстильный шнур



A7767SP-1AB

↓ 16 ∅ 30
 ♀ 10W | LED, 600LM,
 3000K, CRI/RA≥80
 ⚙ 150 ∇ 10



A7768SP-1AB

↓ 30 ∅ 30
 ♀ 10W | LED, 600LM,
 3000K, CRI/RA≥80
 ⚙ 150 ∇ 10



Textile cord -
 Текстильный шнур

A7769SP-1AB

↓ 30 ∅ 17
 ♀ 10W | LED, 600LM,
 3000K, CRI/RA≥80
 ⚙ 150 ∇ 10



Fixture material: metal plated
 Fixture colour: black chrome / antique bronze
 Shade material: glass
 Shade colour: smoky / cognac

Материал арматуры: металл гальванизированный
 Цвет арматуры: черный хром / античная бронза
 Материал плафона: стекло
 Цвет плафона: дымчатый / коньяк





Fixture material: metal plated
 Fixture colour: chrome / gold
 Shade material: glass
 Shade colour: clear / amber

Материал арматуры: металл
 гальванизированный
 Цвет арматуры: хром / золото
 Материал плафона: стекло
 Цвет плафона: прозрачный / янтарный



A1577SP-1GO

↓ 55 ∅ 12
 ∅ 40W | E14
 ⌘ 150 ∇ 8



A1577SP-1CC

↓ 55 ∅ 12
 ∅ 40W | E14
 ⌘ 150 ∇ 8



A470006

↔ 70 ∇ 5



A470033

↔ 70 ∇ 5



A470029

↔ 70 ∇ 5



A470045

↔ 70 ∇ 5



A470002

↔ 70 ∇ 5



A471201

↓ 4 ∅ 12



A471206

↓ 4 ∅ 12

Fixture material: metal painted / metal plated
 Fixture colour: white / chrome / antique bronze
 / black / satin silver / gold

Материал арматуры: металл крашенный /
 металл гальванизированный
 Цвет арматуры: белый / хром / античная
 бронза / черный / матовое серебро / золото

OPTIMA- ACCESSORIES





adjustable central rod
— укорачиваемый
центральный штوك

A4103SP-8CC

↓ 35 ↔ 70 ↗ 130
⌀ 8X60W | E27
⌘ 20-50 ▾ 12



adjustable central rod
— укорачиваемый
центральный штوك

A4103SP-6CC

↓ 35 ↔ 70 ↗ 95
⌀ 6X60W | E27
⌘ 20-50 ▾ 12



A4103AP-1CC

↓ 37 ↔ 23 ↗ 15
⌀ 60W | E27



adjustable central rod
— укорачиваемый
центральный шток

A4103SP-8GO

↓ 39 ↔ 82 ↗ 131
⌀ 8X60W | E27
⌘ 20-50 ▾ 12



A4103AP-1GO

↓ 37 ↔ 15 ↗ 20
⌀ 40W | E27



adjustable central rod
— укорачиваемый
центральный шток



adjustable central rod
— укорачиваемый
центральный шток

A4103SP-6GO

↓ 35 ↔ 70 ↗ 110
⌀ 6X60W | E27
⌘ 20-50 ▾ 12



A4103SP-5GO

↓ 35 ↔ 70 ↗ 90
⌀ 5X60W | E27
⌘ 20-50 ▾ 10



Fixture material: metal plated / metal painted
Fixture colour: polished brass / chrome / gold
Shade material: glass
Shade colour: smoky / white / clear
Материал арматуры: металл гальванизированный / металл крашенный
Цвет арматуры: полированная медь / хром / золото
Материал плафона: стекло
Цвет плафона: дымчатый / белый / прозрачный





A7759AP-1PB

↑ 35 ↔ 23 ↗ 15
 ♀ 60W | E27



adjustable central rod
 — укорачиваемый
 центральный штوك

A4103SP-8PB

↑ 35 ↔ 70 ↗ 130
 ♀ 8X60W | E27
 § 20-50 ∇ 12



adjustable central rod
 — укорачиваемый
 центральный штوك

A4103SP-6PB

↑ 35 ↔ 70 ↗ 95
 ♀ 6X60W | E27
 § 20-50 ∇ 12



textile cable
 - текстильный шнур

A7759SP-1PB

↑ 30 ∅ 15
 ♀ 60W | E27
 § 150 ∇ 8



adjustable central rod
 — укорачиваемый
 центральный штوك

A7759PL-9PB

↑ 48 ∅ 93
 ♀ 9X60W | E27
 ∇ 12



adjustable central rod
 — укорачиваемый
 центральный штوك

A7759PL-6PB

↑ 48 ∅ 85
 ♀ 6X60W | E27
 ∇ 12



Fixture material: metal plated /
 metal painted
 Fixture colour: polished brass /
 chrome / gold
 Shade material: glass
 Shade colour: smoky / white / clear
 Материал арматуры: металл
 гальванизированный / металл
 крашенный
 Цвет арматуры: полированная
 медь / хром / золото
 Материал плафона: стекло
 Цвет плафона: дымчатый / белый
 / прозрачный

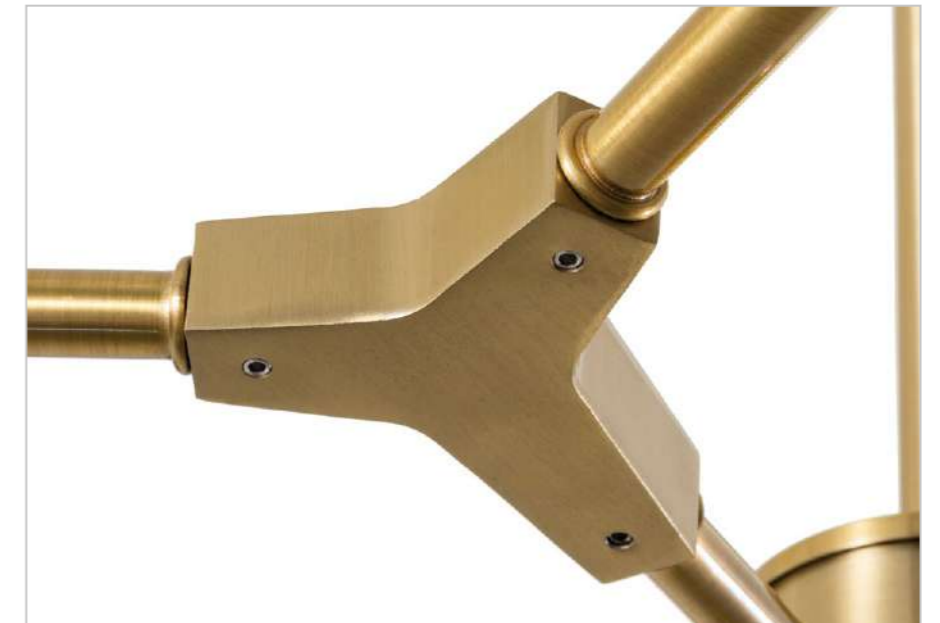



A7770PL-6PB

↓ 35 ∅ 85
 ∅ 6X40W | E14
 ∇ 10



A7770AP-1PB

↓ 35 ↔ 15 ∇ 20
 ∅ 40W | E14



textile cable
 - текстильный шнур

A7770SP-1PB

↓ 37 ∅ 15
 ∅ 40W | E14
 ∇ 150 ∇ 8



adjustable central rod
 – укорачиваемый
 центральный шток



A7770SP-13PB

↓ 55 ∅ 100
 ∅ 13X40W | E14
 ∇ 50/25 ∇ 12



Fixture material: metal plated
 Fixture colour: polished brass
 Shade material: glass
 Shade colour: clear

Материал арматуры: металл
 гальванизированный
 Цвет арматуры: полированная медь
 Материал плафона: стекло
 Цвет плафона: прозрачный



A7770SP-6PB

↓ 37 ↔ 37 ∇ 100
 ∅ 6X40W | E14
 ∇ 110 ∇ 35X5



A7770SP-9PB

↓ 37 ↔ 37 ∇ 120
 ∅ 9X40W | E14
 ∇ 110 ∇ 50X5





A7004PL-8BK

↑ 51 ∅ 86
 ♀ 8X60W | E14
 ∇ 10



A7004PL-5BK

↑ 51 ∅ 68
 ♀ 5X60W | E14
 ∇ 10



A7004SP-6BK

↑ 34 ∅ 75
 ♀ 6X60W | E14
 ∅ 86 ∇ 10



A7004AP-1BK

↑ 34 ↔ 23 ∇ 14
 ♀ 60W | E14



A7004SP-1BK

↑ 35 ↔ 23 ∇ 10
 ♀ 60W | E14
 ∅ 120 ∇ 10

Fixture material: metal painted, metal plated
 Fixture colour: black
 Shade material: glass
 Shade colour: clear

Материал арматуры: металл крашенный, металл гальванизированный
 Цвет арматуры: черный
 Материал плафона: стекло
 Цвет плафона: прозрачный

NUVOLA



A7017SP-4BK

↑ 41 ∅ 40
 ♀ 4X60W | E14
 ∅ 50 ∇ 10



Fixture material: metal painted
 Fixture colour: black
 Shade material: glass
 Shade colour: white

Материал арматуры: металл крашенный
 Цвет арматуры: черный
 Материал плафона: стекло
 Цвет плафона: белый

CASTULA



A7013SP-6BK

↑ 55 ∅ 50
 ♀ 6X60W | E14
 ∅ 50 ∇ 10



Fixture material: metal painted, metal plated
 Fixture colour: black

Материал арматуры: металл крашенный, металл гальванизированный
 Цвет арматуры: черный



A7014SP-8BK

↓ 53 ∅ 60
 ♀ 8X60W | E14
 ⚙ 50 ∇ 10



A7014SP-5BK

↓ 47 ∅ 47
 ♀ 5X60W | E14
 ⚙ 50 ∇ 10



A1722SP-6BA

↓ 67 ∅ 66
 ♀ 6X60W | E14
 ⚙ 80 ∇ 15



A1722AP-1BA

↓ 30 ↔ 11 ∇ 16
 ♀ 60W | E14



A7014AP-1BK

↓ 25 ↔ 12 ∇ 17
 ♀ 60W | E14



Fixture material: metal painted
 Fixture colour: black
 Shade material: glass
 Shade colour: clear

Материал арматуры: металл крашенный
 Цвет арматуры: черный
 Материал плафона: стекло
 Цвет плафона: прозрачный



Fixture material: metal painted
 Fixture colour: antique black
 Shade material: glass
 Shade colour: clear

Материал арматуры: металл крашенный
 Цвет арматуры: античный черный
 Материал плафона: стекло
 Цвет плафона: прозрачный



STEFAN



Led Lampadari

все иллюстрации созданы инструментами нейросети
#Midjourney

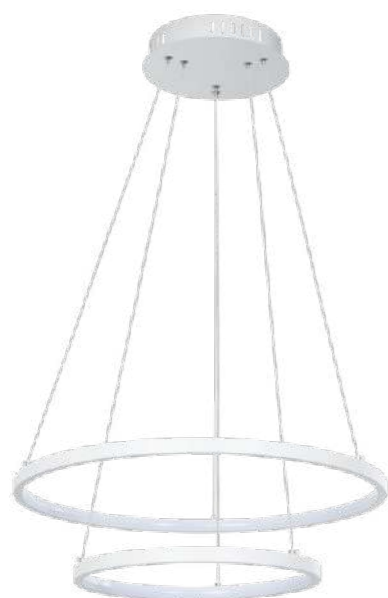

A2197SP-2WH

↑ 3 ∅55
 ♀ 65W | LED, 4000LM,
 3000-6000K, CRI/RA≥80
 ⚙ 120 ∇ 20



A2197SP-3WH

↑ 3 ∅75
 ♀ 145W | LED, 7600LM,
 3000-6000K, CRI/RA≥80
 ⚙ 140 ∇ 22



A2197SP-2BK

↑ 3 ∅55
 ♀ 65W | LED, 2900LM,
 3000-6000K, CRI/RA≥80
 ⚙ 120 ∇ 20

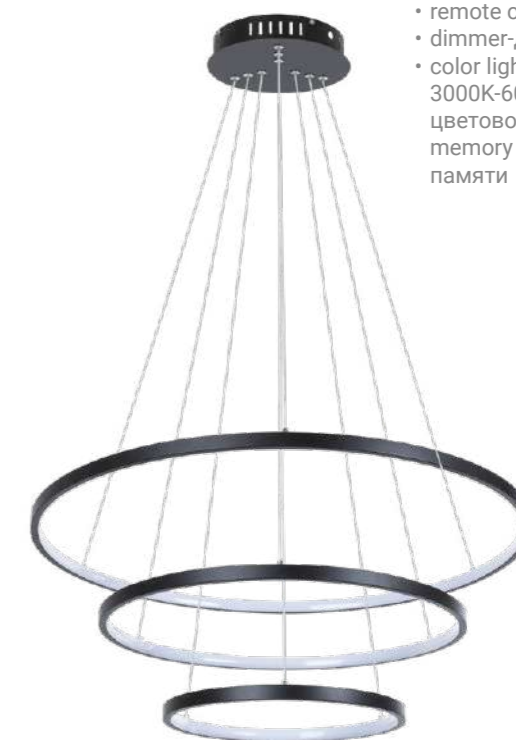

A2197SP-3BK

↑ 3 ∅75
 ♀ 145W | LED, 5400LM,
 3000-6000K, CRI/RA≥80
 ⚙ 140 ∇ 22



- remote control-пульт ДУ
- dimmer-диммирование
- color light change 3000K-6000K - изменение цветовой температуры
- memory function-функция памяти

Fixture material: metal painted
 Fixture colour: white / black
 Shade material: acrylic
 Shade colour: white

Материал арматуры: металл крашенный
 Цвет арматуры: белый / черный
 Материал плафона: акрил
 Цвет плафона: белый

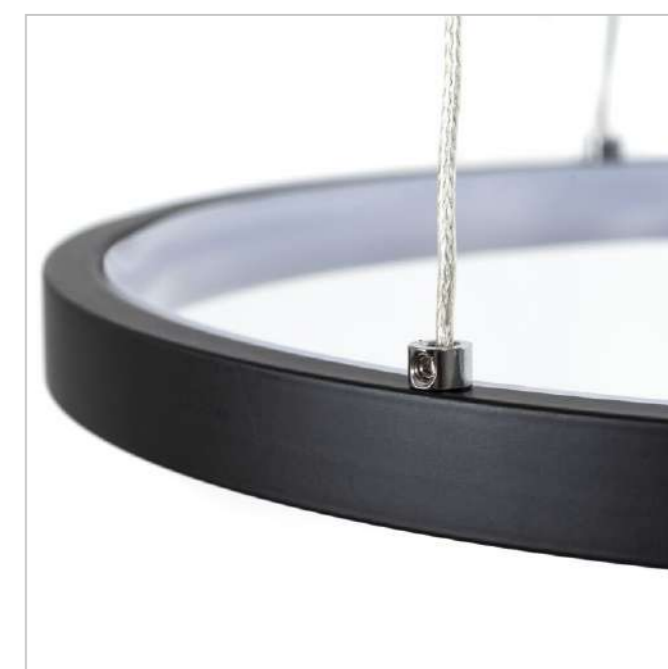



A2198SP-2WH

↓ 4 ∅60
 ♀ 70W | LED, 2500LM,
 3000-6000K, CRI/RA≥80
 ⌀ 120 ∇ 18



A2198SP-3WH

↓ 4 ∅80
 ♀ 155W | LED, 4200LM,
 3000-6000K, CRI/RA≥80
 ⌀ 140 ∇ 20



A2198SP-3BK

↓ 4 ∅80
 ♀ 145W | LED, 5300LM,
 3000-6000K, CRI/RA≥80
 ⌀ 140 ∇ 20



A2198SP-2BK

↓ 4 ∅60
 ♀ 70W | LED, 2500LM,
 3000-6000K, CRI/RA≥80
 ⌀ 120 ∇ 18



- remote control-пульт ДУ
- dimmer-диммирование
- color light change 3000K-6000K - изменение цветовой температуры
- memory function-функция памяти



A2198SP-3GO

↓ 4 ∅80
 ♀ 150W | LED, 7000LM,
 3000-6000K, CRI/RA≥80
 ⌀ 140 ∇ 20



A2198SP-2GO

↓ 4 ∅60
 ♀ 70W | LED, 3900LM,
 3000-6000K, CRI/RA≥80
 ⌀ 120 ∇ 18



Fixture material: metal painted / metal plated
 Fixture colour: white / black / chrome / gold
 Shade material: acrylic
 Shade colour: white

Материал арматуры: металл крашенный / металл гальванизированный
 Цвет арматуры: белый / черный / хром / золото
 Материал плафона: акрил
 Цвет плафона: белый





A2198SP-2CC

↓ 4 Ø 60
 ♀ 70W | LED, 2500LM,
 3000-6000K, CRI/RA≥80
 ⌀ 120 ▽ 18



A2198SP-3CC

↓ 4 Ø 80
 ♀ 150W | LED, 6700LM,
 3000-6000K, CRI/RA≥80
 ⌀ 140 ▽ 20



A2196SP-2CC

↓ 5 Ø 70
 ♀ 60W | LED, 6600LM,
 3000-6000K, CRI/RA≥80
 ⌀ 120 ▽ 19



A2196SP-3CC

↓ 24 Ø 80
 ♀ 75W | LED, 9000LM,
 3000-6000K, CRI/RA≥80
 ⌀ 120 ▽ 20



- remote control-пульт ДУ
- dimmer-диммирование
- color light change
 3000K-6000K - изменение
 цветовой температуры
 memory function-функция
 памяти

Fixture material: metal painted / metal plated
 Fixture colour: white / black / chrome / gold
 Shade material: acrylic
 Shade colour: white

Материал арматуры: металл крашенный / металл гальванизированный
 Цвет арматуры: белый / черный / хром / золото
 Материал плафона: акрил
 Цвет плафона: белый



HARLEY

Fixture material: metal plated
 Fixture colour: chrome
 Shade material: acrylic
 Shade colour: white / clear

Материал арматуры: металл
 гальванизированный
 Цвет арматуры: хром
 Материал плафона: акрил
 Цвет плафона: белый /
 прозрачный



ALFIE



A2180SP-60WH

↓ 4 Ø86
 ♀ 60W | LED, 3400LM,
 3000-6000K, CRI/RA≥80
 ⚙ 180 ∇ 24



A2180SP-60BK

↓ 4 Ø86
 ♀ 60W | LED, 3400LM,
 3000-6000K, CRI/RA≥80
 ⚙ 180 ∇ 24



- remote control-пульт ДУ
- dimmer-диммирование
- color light change
 3000K-6000K - изменение
 цветовой температуры
 memory function-функция
 памяти



NEW
A2211SP-2WH

↓ 3 Ø70
 ♀ 60W | LED, 3000LM,
 3000-5700K, CRI/RA≥70



NEW
A2211SP-2BK

↓ 3 Ø70
 ♀ 60W | LED, 3000LM,
 3000-5700K, CRI/RA≥70



- remote control-пульт ДУ
- dimmer-диммирование
- color light change
 3000K-5700K - изменение
 цветовой температуры
 memory function-функция
 памяти

LED LAMPADARI

Fixture material: metal painted
 Fixture colour: black / white
 Shade material: plastic
 Shade colour: clear

Материал арматуры: металл крашенный
 Цвет арматуры: черный / белый
 Материал плафона: пластик
 Цвет плафона: прозрачный

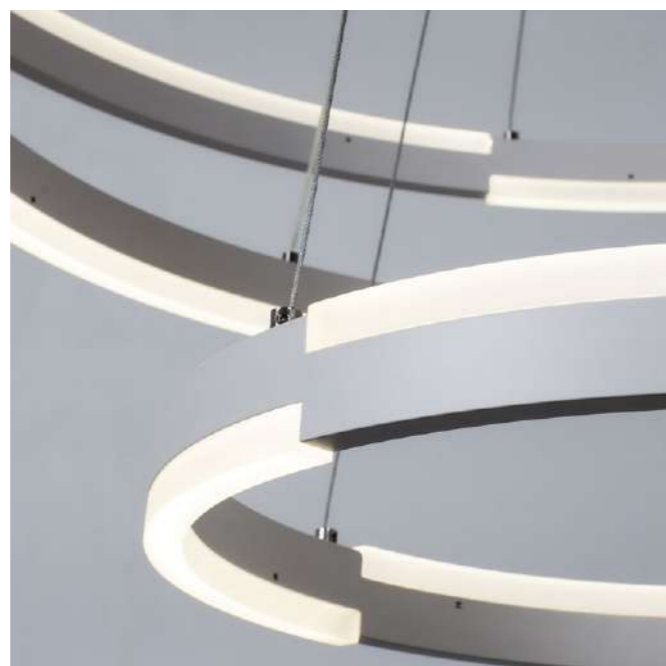

VERITATE

Fixture material: metal painted
 Fixture colour: white / black
 Shade material: acrylic
 Shade colour: white

Материал арматуры: металл крашенный
 Цвет арматуры: белый / черный
 Материал плафона: акрил
 Цвет плафона: белый

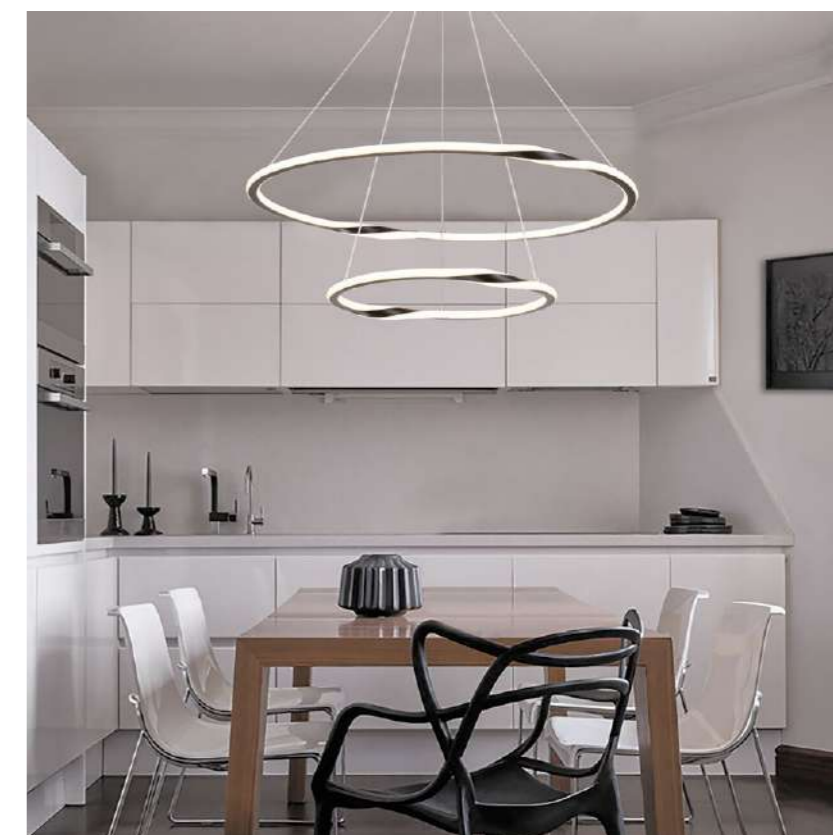

ALFIE | VERITATE

SMOOTH



A2223SP-1BK

↓ 3 ∅ 60
 ♀ 42W | LED, 2100LM,
 4000K, CRI/RA≥80
 ⌀ 150 ∇ 7



Fixture material: metal plated
 Fixture colour: polished brass / black
 Shade material: acrylic
 Shade colour: white

Материал арматуры: металл
 гальванизированный
 Цвет арматуры: полированная
 медь / черный
 Материал плафона: акрил
 Цвет плафона: белый



A2223SP-1PB

↓ 3 ∅ 60
 ♀ 42W | LED, 2100LM,
 4000K, CRI/RA≥80
 ⌀ 150 ∇ 7



- remote control-пульт ДУ
- dimmer-диммирование
- color light change
 3000K-6000K - изменение
 цветовой температуры
- memory function-функция
 памяти



NEW

A1847SP-36BK

↓ 5 ↔ 65 ↗ 42
 ♀ 36W | LED, 1800LM,
 4000K, CRI/RA≥80
 ⌀ 145 ∇ 16



NEW

A1847SP-46BK

↓ 5 ↔ 80 ↗ 52
 ♀ 46W | LED, 2300LM,
 4000K, CRI/RA≥80
 ⌀ 145 ∇ 16



MADISON



A2194SP-2BK

↓ 3 ∅ 76
 ♀ 40W | LED, 1200LM,
 2700-6500K, CRI/RA≥80
 ∇ 16



A2194SP-2PB

↓ 3 ∅ 76
 ♀ 40W | LED, 1200LM,
 2700-6500K, CRI/RA≥80
 ∇ 16



Fixture material: metal plated
 Fixture colour: black
 Shade material: silicon
 Shade colour: white

Материал арматуры: металл
 гальванизированный
 Цвет арматуры: черный
 Материал плафона: силикон
 Цвет плафона: белый

CINTA





NEW
A2222SP-3BK

↑ 5 ↔ 80 ↗ 154
 ∅ 129W | LED, 1400LM,
 3000-6000K, CRI/RA≥80
 ∅ 140



Fixture material: metal painted
 Fixture colour: black
 Shade material: acrylic
 Shade colour: white

Материал арматуры: металл
 крашенный
 Цвет арматуры: черный
 Материал плафона: акрил
 Цвет плафона: белый

NEW
A2222SP-1BK

↑ 5 ∅ 60
 ∅ 65W | LED, 2080LM,
 3000-6000K, CRI/RA≥80
 ∅ 100



A2185SP-3BK

↑ 6 ∅ 148
 ∅ 226W | LED, 9000LM,
 3000-6000K, CRI/RA≥80
 ∅ 150 ∇ 24



- remote control-пульт ДУ
- dimmer-диммирование
- color light change
 3000K-6000K - изменение
 цветовой температуры
 memory function-функция
 памяти



A2183SP-1BK

↑ 6 ∅ 60
 ∅ 76W | LED, 3000LM, 3000-6000K,
 CRI/RA≥80
 ∅ 120 ∇ 7



Fixture material: metal painted
 Fixture colour: black
 Shade material: acrylic
 Shade colour: clear

Материал арматуры: металл
 крашенный
 Цвет арматуры: черный
 Материал плафона: акрил
 Цвет плафона: прозрачный

MERCURY





NEW

A1874SP-45BK

↓ 7 ∅ 80
 ♀ 45W | LED, 2250LM,
 4000K, CRI/RA≥80
 ⚙ 143



NEW

A1874SP-32BK

↓ 7 ∅ 60
 ♀ 32W | LED, 1600LM,
 4000K, CRI/RA≥80
 ⚙ 143 ∇ 20



Fixture material: metal painted
 Fixture colour: black
 Shade material: acrylic
 Shade colour: white

Материал арматуры: металл крашенный
 Цвет арматуры: черный
 Материал плафона: акрил
 Цвет плафона: белый



NEW

A2221SP-1BR

↓ 5 ∅ 65
 ♀ 61W | LED, 2580LM,
 3000-6000K, CRI/RA≥80
 ⚙ 100



- remote control-пульт ДУ
- dimmer-диммирование
- color light change 3000K-6000K - изменение цветовой температуры
- memory function-функция памяти

VERITATE



Fixture material: metal painted
 Fixture colour: brown
 Shade material: acrylic
 Shade colour: white

Материал арматуры: металл крашенный
 Цвет арматуры: коричневый
 Материал плафона: акрил
 Цвет плафона: белый



Fixture material: metal painted
 Fixture colour: black / white
 Shade material: PC
 Shade colour: white

Материал арматуры: металл крашенный
 Цвет арматуры: черный / белый
 Материал плафона: пластик
 Цвет плафона: белый



A2182SP-160PB

↑ 3 ∅ 80
 ♀ 160W | LED, 9000LM,
 3000-6000K, CRI/RA≥80
 ⚙ 180 ∇ 28



A2182SP-160CC

↑ 3 ∅ 80
 ♀ 160W | LED, 9000LM,
 3000K-6000K, CRI/RA≥80
 ⚙ 180 ∇ 28



A2522SP-2BK

↑ 13 ∅ 68
 ♀ 162W | LED, 6680LM, 3000-6000K, CRI/RA≥80
 ⚙ 100 ∇ 18

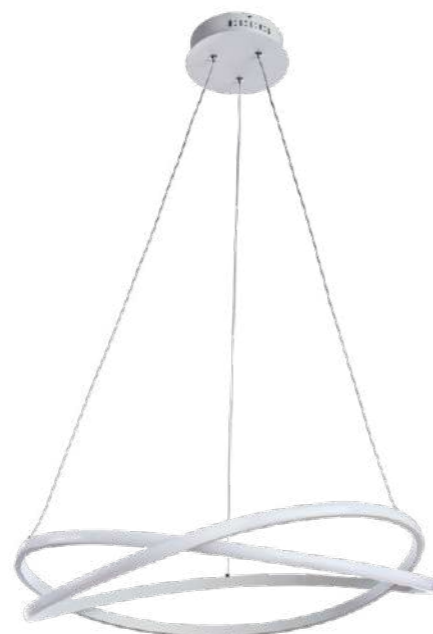

A2522SP-2WH

↑ 13 ∅ 68
 ♀ 162W | LED, 9100LM, 3000-6000K, CRI/RA≥80
 ⚙ 100 ∇ 18



Fixture material: metal plated
 Fixture colour: chrome / polished brass
 Shade material: plastic
 Shade colour: clear

Материал арматуры: металл гальванизированный
 Цвет арматуры: хром / полированная медь
 Материал плафона: пластик
 Цвет плафона: прозрачный



ORIONE



Fixture material: metal painted
 Fixture colour: black
 Shade material: acrylic
 Shade colour: white

Материал арматуры: металл крашенный
 Цвет арматуры: черный
 Материал плафона: акрил
 Цвет плафона: белый



A2189LM-1BK

↓ 4,3 ∅ 60
 ∅ 32W | LED, 1600LM,
 2800-6500K, CRI/RA≥80
 ⌀ 56 ∇ 18



Light direction
 up and down –
 направление света
 вверх и вниз



A2186SP-1BK

↓ 15 ∅ 80
 ∅ 75W | LED, 6000LM,
 3000-6000K, CRI/RA≥80
 ⌀ 105 ∇ 19



A2186SP-1WH

↓ 15 ∅ 80
 ∅ 75W | LED, 6000LM,
 3000-6000K, CRI/RA≥80
 ⌀ 105 ∇ 19



A2190SP-1BK

↓ 3,5 ↔ 1,8 ↗ 100
 ∅ 17W | LED, 850LM,
 4000K, CRI/RA≥80



A2189SP-1BK

↓ 4,3 ↔ 1,8 ↗ 100
 ∅ 30W | LED, 1500LM,
 2800-6500K, CRI/RA≥80
 ⌀ 116 ∇ 20*4*6



Light direction
 up and down –
 направление света
 вверх и вниз

Fixture material: metal painted
 Fixture colour: black / white
 Shade material: acrylic
 Shade colour: white

Материал арматуры: металл крашенный
 Цвет арматуры: черный / белый
 Материал плафона: акрил
 Цвет плафона: белый



RING



Fixture material: metal painted
 Fixture colour: gold
 Shade material: acrylic
 Shade colour: clear

Материал арматуры: металл крашенный
 Цвет арматуры: золото
 Материал плафона: акрил
 Цвет плафона: прозрачный



A2187SP-2GO

↓ 16 ∅ 27
 ♀ 14W | LED, 1000LM,
 4000K, CRI/RA≥80
 ⚙ 97 ∇ 15



A2187LM-1GO

↓ 16 ∅ 50
 ♀ 72W | LED, 4700LM,
 3000-5700K, CRI/RA≥75
 ⚙ 116 ∇ 22



A2187LM-3GO

↓ 16 ∅ 156
 ♀ 170W | LED, 9000LM,
 3000-6000K, CRI/RA≥80
 ⚙ 146 ∇ 24

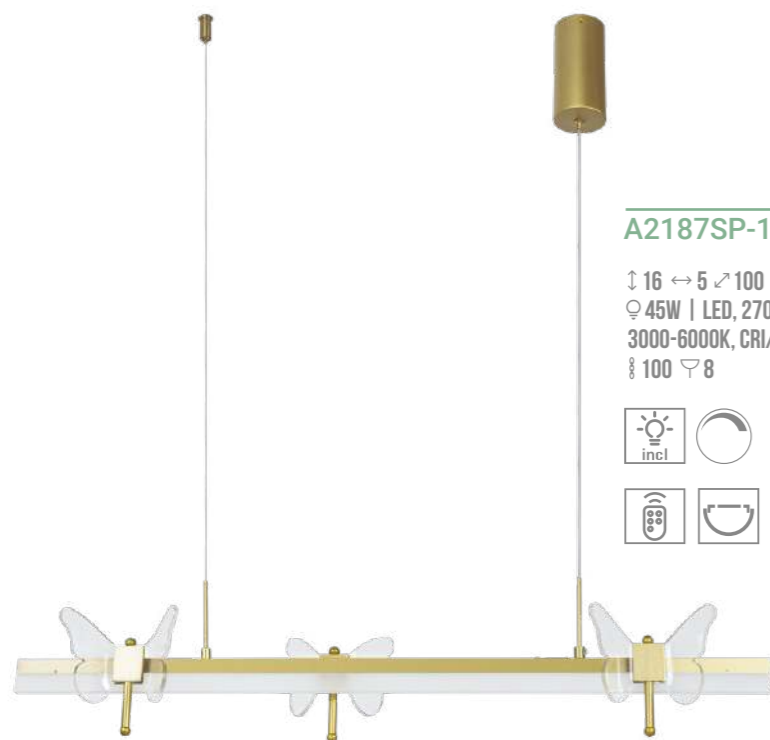

A2187SP-1GO

↓ 16 ↔ 5 ↗ 100
 ♀ 45W | LED, 2700LM,
 3000-6000K, CRI/RA≥80
 ⚙ 100 ∇ 8



A2187AP-1GO

↓ 20 ↔ 19 ↗ 23
 ♀ 7W | LED, 500LM,
 4000K, CRI/RA≥80
 ∇ 12

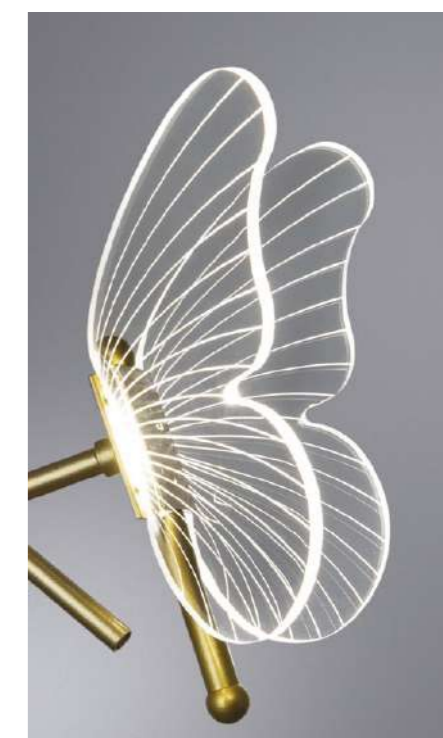

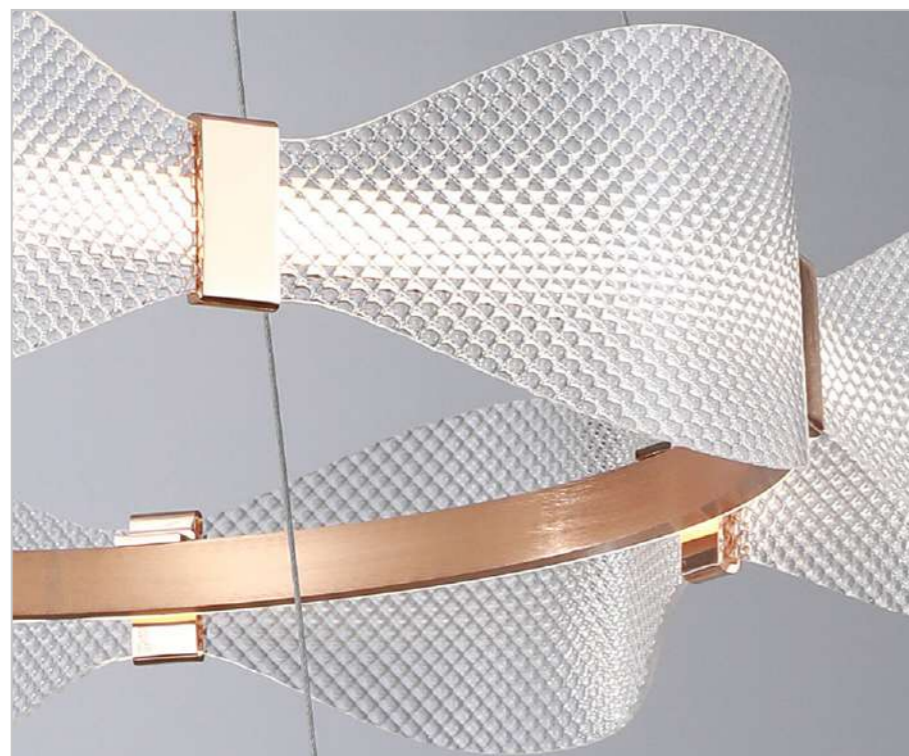

NEW
A1868AP-1PB

↓ 11 ↔ 23 ↗ 11
 ♀ 4W | LED, 200LM,
 4000K, CRI/RA≥80



Fixture material: metal plated
 Fixture colour: polished brass
 Shade material: acrylic
 Shade colour: clear

Материал арматуры: металл
 гальванизированный
 Цвет арматуры: латунь
 Материал плафона: акрил
 Цвет плафона: прозрачный



NEW
A1868SP-1PB

↓ 11 ∅ 60
 ♀ 28W | LED, 1400LM,
 4000K, CRI/RA≥80
 ⚙ 139 ∇ 18



NEW
A1868SP-2PB

↓ 11 ∅ 60
 ♀ 43W | LED, 2150LM,
 4000K, CRI/RA≥80
 ⚙ 169 ∇ 22



NEW
A1868SP-3PB

↓ 11 ∅ 88
 ♀ 72W | LED, 3600LM,
 4000K, CRI/RA≥80
 ⚙ 189 ∇ 26



NEW
A2283AP-1GO

↓ 32 ↔ 24 ↗ 8
 ♀ 4W | LED, 200LM,
 4000K, CRI/RA≥80



GRAPPOLO

NEW
A2283SP-14GO

↓ 300 ∅ 70
 ♀ 42W | LED, 2100LM,
 4000K, CRI/RA≥80
 ∇ 70



Fixture material: metal plated
 Fixture colour: gold
 Shade material: acrylic
 Shade colour: clear

Материал арматуры: металл
 гальванизированный
 Цвет арматуры: золото
 Материал плафона: такрил
 Цвет плафона: прозрачный





Fixture material: metal plated
 Fixture colour: gold
 Shade material: plastic / acrylic
 Shade colour: clear

Материал арматуры: металл
 гальванизированный
 Цвет арматуры: золото
 Материал плафона: пластик / акрил
 Цвет плафона: прозрачный



A2489AP-1GO

↓ 31 ↔ 14 ↗ 12
 ∅ 8W | LED, 400LM,
 4000K, CRI/RA≥80



NEW

A7777SP-3GO

↓ 150 ∅ 47
 ∅ 12W | LED, 600LM,
 4000K, CRI/RA≥80
 ∇ 30



NEW

A7777SP-5GO

↓ 200 ∅ 51
 ∅ 21W | LED, 1050LM,
 4000K, CRI/RA≥80
 ∇ 35



NEW

A7777SP-10GO

↓ 300 ∅ 66
 ∅ 40W | LED, 2000LM,
 4000K, CRI/RA≥80
 ∇ 50



A2489SP-1GO

↓ 120 ↔ 4 ↗ 12
 ∅ 8W | LED, 400LM,
 4000K, CRI/RA≥80
 ∇ 96 ∇ 10



NEW

A2489PL-8GO

↓ 18 ∅ 92
 ∅ 79W | LED, 3950LM, 3000-
 6500K, CRI/RA≥80
 ∇ 10



NEW

A2489PL-5GO

↓ 18 ∅ 82
 ∅ 51W | LED, 2550LM, 3000-
 6500K, CRI/RA≥80
 ∇ 10



NEW

A7777AP-1GO

↓ 22 ↔ 12 ↗ 21
 ∅ 4W | LED, 200LM,
 4000K, CRI/RA≥80
 ∇ 10



Fixture material: metal plated
 Fixture colour: gold
 Shade material: acrylic
 Shade colour: clear

Материал арматуры: металл
 гальванизированный
 Цвет арматуры: золото
 Материал плафона: акрил
 Цвет плафона: прозрачный

MONTANA





A2780LM-30PB

↓ 15 ∅ 60
 ♀ 30W | LED, 3080LM,
 3000K, CRI/RA≥80
 ⚙ 135 ∇ 18



Fixture material: metal plated
 Fixture colour: polished brass
 Shade material: acrylic / plastic, glass
 Shade colour: white



A2780LM-40PB

↓ 15 ∅ 80
 ♀ 40W | LED, 4165LM,
 3000K, CRI/RA≥80
 ⚙ 135 ∇ 15



Материал арматуры: металл гальванизированный
 Цвет арматуры: полированная медь
 Материал плафона: акрил / пластик, стекло
 Цвет плафона: белый



NEW
A2471LM-20BK

↓ 12 ∅ 85
 ♀ 60W | LED, 3000LM,
 4000K, CRI/RA≥80
 ⚙ 120 ∇ 15



NEW
A2471LM-16BK

↓ 12 ∅ 65
 ♀ 48W | LED, 2400LM,
 4000K, CRI/RA≥80
 ⚙ 120 ∇ 15



SATURN



A7790SP-50BK

↓ 30 ↔ 33 ↗ 120
 ♀ 65W/X15W | LED/G9,
 4600LM, 4000K/600LM, K,
 CRI/RA≥80
 ∇ 8



Fixture material: metal painted
 Fixture colour: black
 Shade material: acrylic
 Shade colour: clear / white

Материал арматуры: металл крашенный
 Цвет арматуры: черный
 Материал плафона: акрил
 Цвет плафона: прозрачный / белый



NEW
A2471SP-12BK

↓ 12 ↔ 120
 ♀ 36W | LED, 1800LM,
 4000K, CRI/RA≥80
 ⚙ 12 ∇ 52*6



Fixture material: metal painted
 Fixture colour: black
 Shade material: glass
 Shade colour: smoky

Материал арматуры: металл крашенный
 Цвет арматуры: черный
 Материал плафона: стекло
 Цвет плафона: дымчатый

MARKAB





A2850SP-80PB

↓ 60 ↔ ↗ 150
 ∅ 55W | LED, 8000LM,
 3000K, CRI/RA≥80
 ⌀ 150 ∇ 18



A2850SP-45PB

↓ 150 ↔ 125 ↗ 167
 ∅ 47W | LED, 5400LM,
 4000K, CRI/RA≥80
 ⌀ 150 ∇ 14



NEW

A2850PL-32PB

↓ 9 ↔ 300 ↗ 6
 ∅ 32W | LED, 1600LM,
 4000K, CRI/RA≥80
 ∇ 6*12



A2850SP-75PB

↓ 35 ↔ 30 ↗ 120
 ∅ 46W | LED, 7000LM,
 3000K, CRI/RA≥80
 ⌀ 115 ∇ 43



A2850LM-75PB

↓ 40 ∅ 70
 ∅ 46W | LED, 8320LM,
 3000K, CRI/RA≥80
 ⌀ 110 ∇ 16



A2850AP-13PB

↓ 90 ↔ 16 ↗ 30
 ∅ 13W | LED, 1430LM,
 3000K, CRI/RA≥80



A2850PN-35PB

↓ 170 ∅ 40
 ∅ 30W | LED, 4200LM,
 3000K, CRI/RA≥80
 ∅ 200





NEW
A2850PL-32BK

↓ 9 ↔ 300 ↗ 6
 ∅ 32W | LED, 1600LM,
 4000K, CRI/RA≥80
 ∇ 6*12

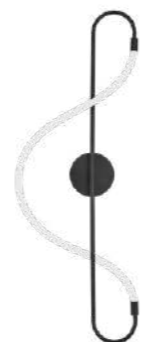

A2850AP-13BK

↓ 90 ↔ 16 ↗ 30
 ∅ 13W | LED, 1430LM,
 3000K, CRI/RA≥80



A2850SP-75BK

↓ 35 ↔ 30 ↗ 120
 ∅ 46W | LED, 7000LM,
 3000K, CRI/RA≥80
 ⌀ 115 ∇ 43



A2850SP-45BK

↓ 150 ↔ 125 ↗ 167
 ∅ 47W | LED, 5400LM,
 4000K, CRI/RA≥80
 ⌀ 150 ∇ 14

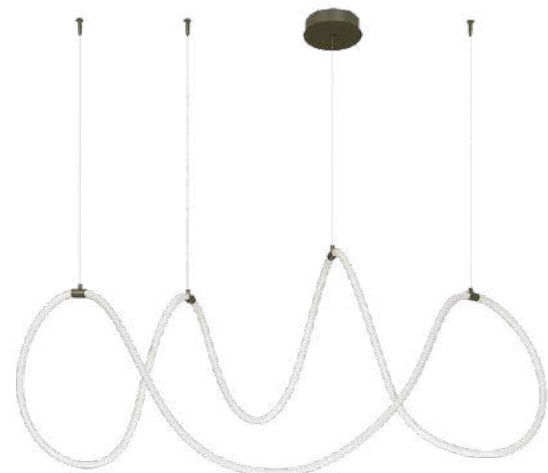

A2850SP-80BK

↓ 60 ↔ ↗ 150
 ∅ 55W | LED, 8000LM,
 3000K, CRI/RA≥80
 ⌀ 150 ∇ 18



A2850PN-35BK

↓ 170 ∅ 40
 ∅ 30W | LED, 4200LM,
 3000K, CRI/RA≥80
 ∅ 200



Fixture material: metal plated /
 metal painted
 Fixture colour: polished brass / black
 Shade material: acrylic / silicone
 Shade colour: white

Материал арматуры: металл
 гальванизированный / металл
 крашенный
 Цвет арматуры: полированная
 медь / черный / латунь
 Материал плафона: акрил /
 силикон
 Цвет плафона: белый



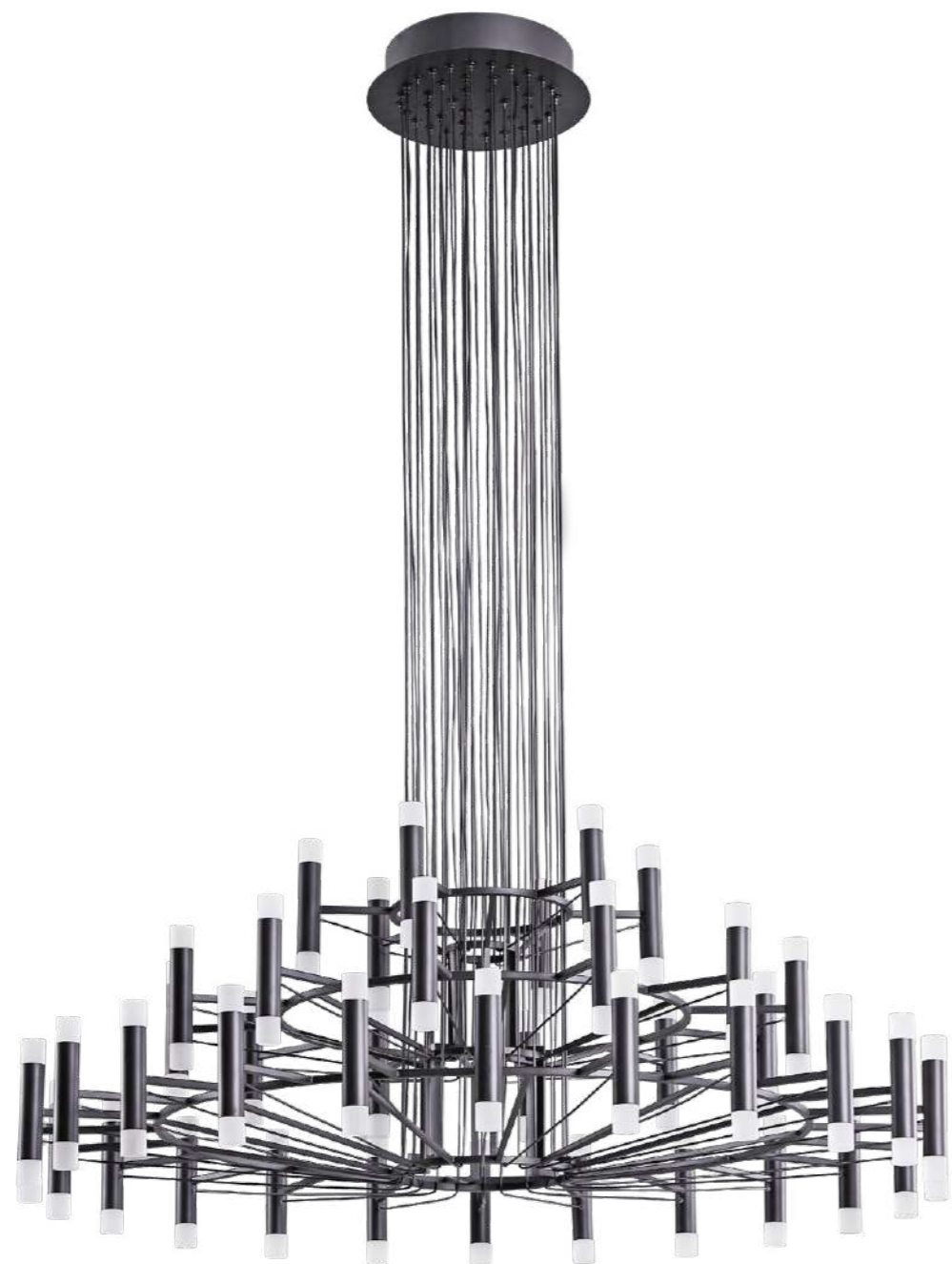

NEW

A2482SP-84BK

↓ 40 ∅ 100
 ∅ 252W | LED, 12600LM,
 3500K, CRI/RA≥80
 ⚡ 3000 ∇ 26



Fixture material: metal painted
 Fixture colour: black
 Shade material: acrylic
 Shade colour: white

Материал арматуры: металл крашенный
 Цвет арматуры: черный
 Материал плафона: акрил
 Цвет плафона: белый

NEW

A2482SP-20BK

↓ 15 ∅ 50
 ∅ 60W | LED, 3000LM,
 3500K, CRI/RA≥80
 ⚡ 120 ∇ 16

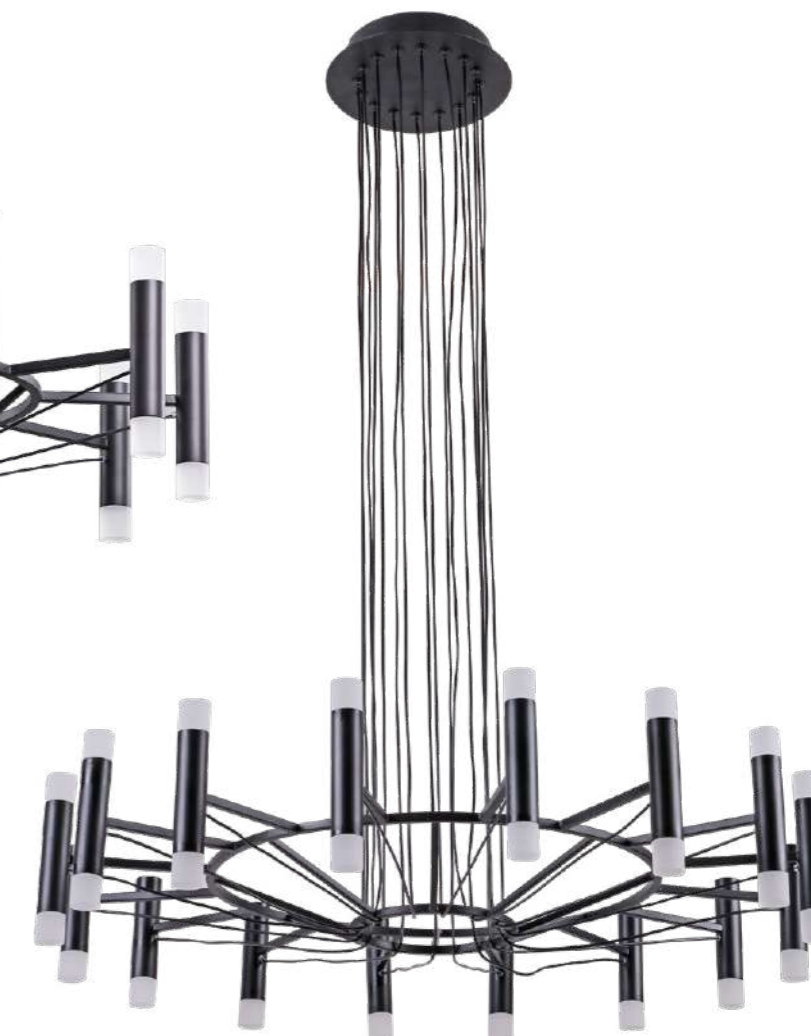

NEW

A2482SP-32BK

↓ 15 ∅ 70
 ∅ 96W | LED, 4800LM,
 3500K, CRI/RA≥80
 ⚡ 120 ∇ 20





NEW
A2233AP-20GO

↓ 45 ↔ 15 ↗ 8
 ∅ 20W | LED, 1000LM,
 3500K, CRI/RA≥80



NEW
A2233SP-20GO

↓ 45 ↔ 15 ↗ 2
 ∅ 20W | LED, 1000LM,
 3500K, CRI/RA≥80
 ∇ 12



NEW
A2233AP-20BK

↓ 45 ↔ 15 ↗ 8
 ∅ 20W | LED, 1000LM,
 3500K, CRI/RA≥80



NEW
A2233SP-20BK

↓ 45 ↔ 15 ↗ 2
 ∅ 20W | LED, 1000LM,
 3500K, CRI/RA≥80
 ∇ 12



Fixture material: metal plated / metal painted
 Fixture colour: gold / black
 Shade material: acrylic
 Shade colour: white

Материал арматуры: металл
 гальванизированный / металл крашеный
 Цвет арматуры: золото / черный
 Материал плафона: акрил
 Цвет плафона: белый



A2918SP-1BK

↓ 150 ∅ 16
 ♀ 14W | LED, 700LM,
 4000K, CRI/RA≥80
 ∇ 7



multi-fastening -
 мультикрепление
 (2 вида)

Fixture material: metal painted
 Fixture colour: black
 Shade material: artificial stone
 Shade colour: white

Материал арматуры: металл крашенный
 Цвет арматуры: черный
 Материал плафона: искусственный камень
 Цвет плафона: белый



A2918PN-1BK

↓ 300 ∅ 16
 ♀ 22W | LED, 1100LM,
 4000K, CRI/RA≥80



Fixture material: metal painted
 Fixture colour: black
 Shade colour: white

Материал арматуры: металл крашенный
 Цвет арматуры: черный
 Цвет плафона: белый

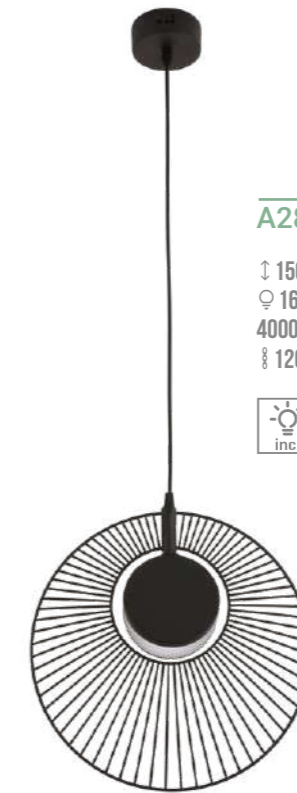

A2808SP-1BK

↓ 150 ∅ 35
 ♀ 16W | LED, 800LM,
 4000K, CRI/RA≥80
 ∅ 120 ∇ 10



LAYLA





NEW

A2341SP-4BK

↓ 12 ↔ 74 ↗ 12
 ∅ 12W | LED, 600LM,
 4000K, CRI/RA≥80
 ⌀ 120 ∇ 16

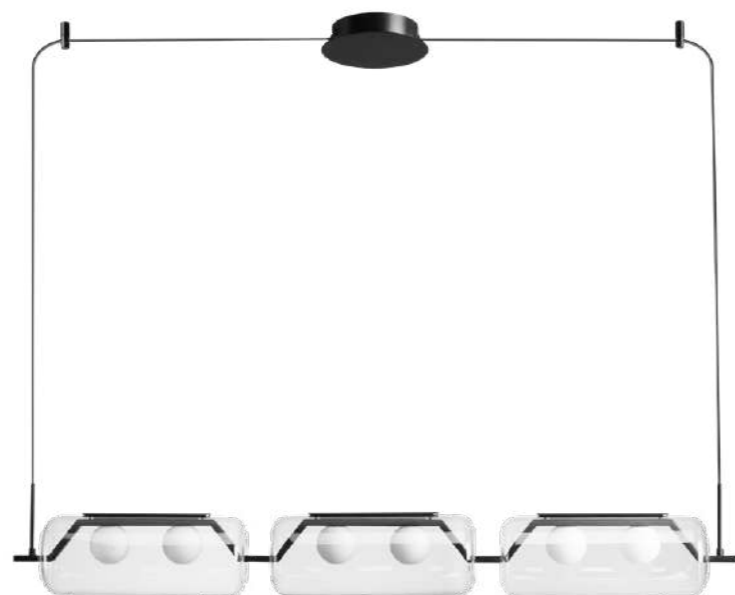

NEW

A2341SP-6BK

↓ 12 ↔ 108 ↗ 12
 ∅ 18W | LED, 900LM,
 4000K, CRI/RA≥80
 ⌀ 120 ∇ 16



NEW

A2341SP-2BK

↓ 47 ∅ 12
 ∅ 6W | LED, 300LM,
 4000K, CRI/RA≥80
 ⌀ 70 ∇ 15



Fixture material: metal painted
 Fixture colour: black
 Shade material: glass
 Shade colour: clear

Материал арматуры: металл крашенный
 Цвет арматуры: черный
 Материал плафона: стекло
 Цвет плафона: прозрачный



A2174SP-5BK

↓ 19 ↔ 9 ↗ 105
 ∅ 5X56W | LED, 5320LM,
 3000-6000K, CRI/RA≥80
 ⌀ 150 ∇ 16



POPLAR

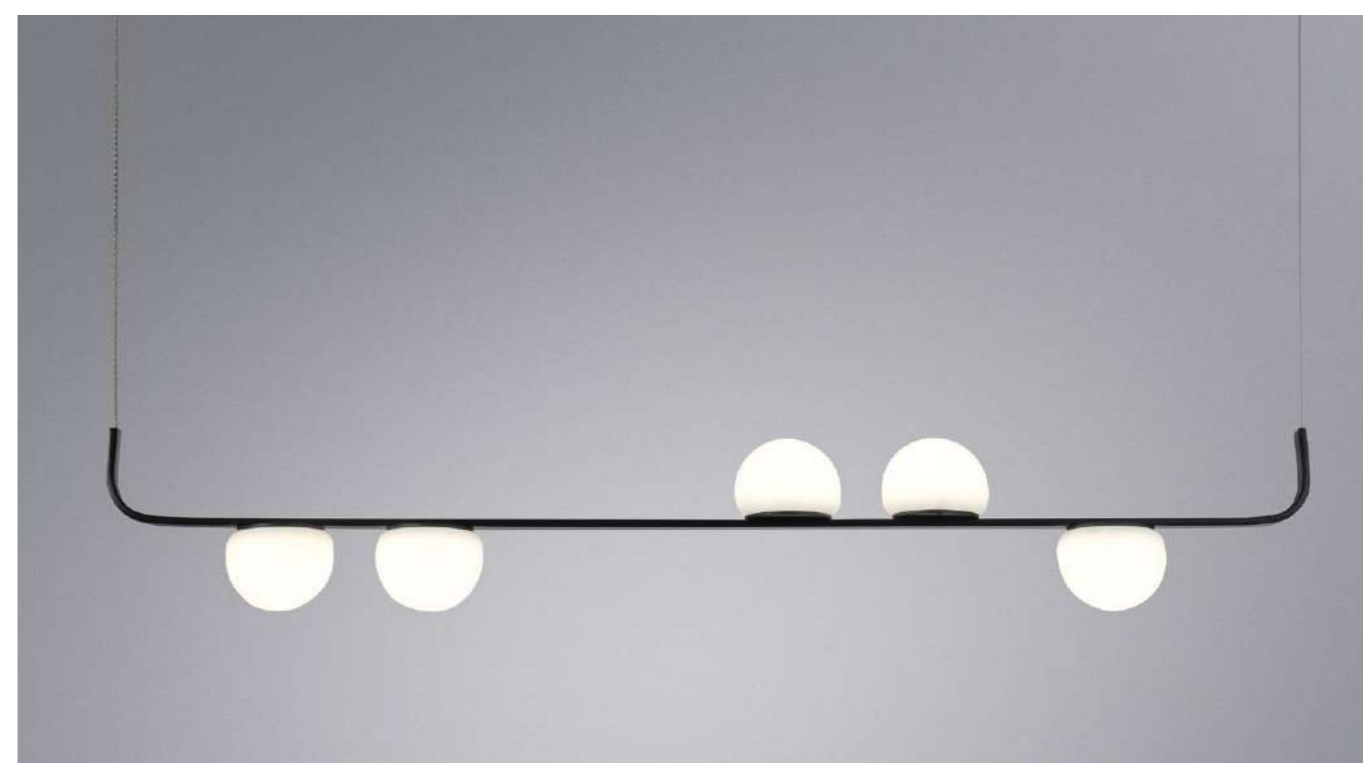



A2917SP-33BK

↑ 36 ↔ 150 ↗ 2
 ∅ 33W | LED, 1650LM,
 4000K, CRI/RA≥80
 ⌀ 120 ∇ 52



Fixture material: metal painted
 Fixture colour: black
 Shade colour: white

Материал арматуры: металл
 крашенный
 Цвет арматуры: черный
 Цвет плафона: белый

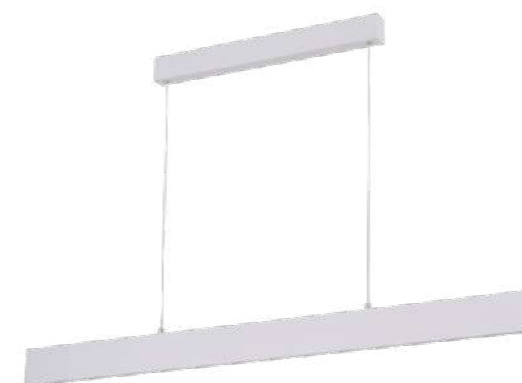

A2505SP-2WH

↑ 8 ↔ 1,5 ↗ 120
 ∅ 30W | LED, 2700LM, 4000K, CRI/RA≥80
 ⌀ 120 ∇ 55



Light direction
 up and down –
 направление света
 вверх и вниз



A2505SP-2BK

↑ 8 ↔ 1,5 ↗ 120
 ∅ 30W | LED, 2700LM, 4000K, CRI/RA≥80
 ⌀ 120 ∇ 55



Light direction
 up and down –
 направление света
 вверх и вниз

LARGO



Fixture material: aluminum
 Fixture colour: black / white
 Shade material: acrylic
 Shade colour: white

Материал арматуры: алюминий
 Цвет арматуры: черный / белый
 Материал плафона: акрил
 Цвет плафона: белый



A2195SP-5BK

↓ 130 ∅ 160
 ∅ 100W | LED, 5000LM, 2800-6500K, CRI/RA≥80
 ∇ 22



A2195AP-1BK

↓ 32 ∅ 30
 ∅ 15W | LED, 750LM,
 4000K, CRI/RA≥80



Fixture material: metal painted
 Fixture colour: black
 Shade material: acrylic
 Shade colour: white

Материал арматуры: металл
 крашенный
 Цвет арматуры: черный
 Материал плафона: акрил
 Цвет плафона: белый



A2199PL-6BK

↓ 22 ∅ 100
 ∅ 130W | LED, 6700LM,
 3000-6000K, CRI/RA≥80
 ∇ 31



A2199PL-5BK

↓ 19 ∅ 60
 ∅ 55W | LED, 2700LM,
 3000-6000K, CRI/RA≥80
 ∇ 26



ZULU



NEW

A2170PL-49BK

↓ 55 ↔ 90 ∅ 60
 ∅ 49W | LED, 2450LM, 3000K-6000K,
 CRI/RA≥80
 ∇ 15



Fixture material: metal painted
 Fixture colour: black
 Shade material: acrylic
 Shade colour: white

Материал арматуры: металл
 крашенный
 Цвет арматуры: черный
 Материал плафона: акрил
 Цвет плафона: белый

Fixture material: metal painted
 Fixture colour: black
 Shade material: acrylic
 Shade colour: white

Материал арматуры: металл крашенный
 Цвет арматуры: черный
 Материал плафона: акрил
 Цвет плафона: белый



FERNANDO





Fixture material: metal painted
 Fixture colour: black / gold
 Shade material: acrylic
 Shade colour: white

Материал арматуры: металл крашенный
 Цвет арматуры: черный / золото
 Материал плафона: акрил
 Цвет плафона: белый

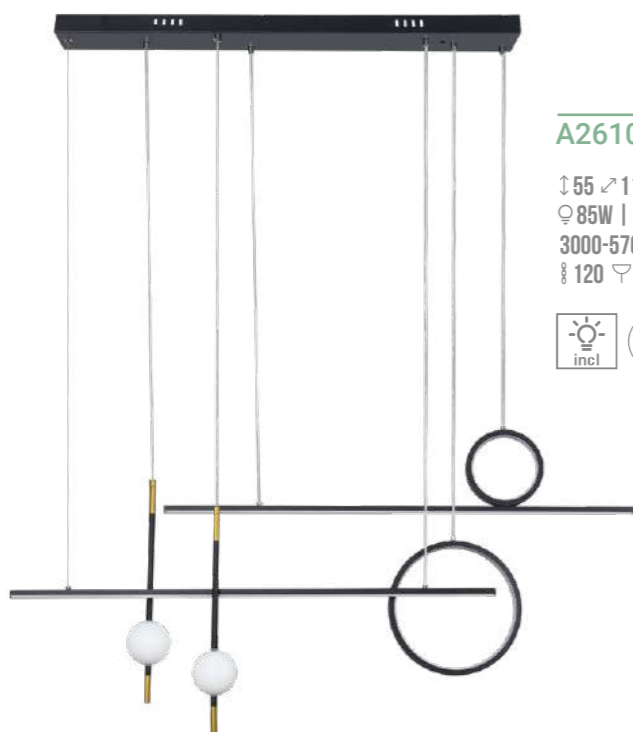

A2610SP-85BK

↓ 55 ↗ 118
 ∅ 85W | LED, 4400LM,
 3000-5700K, CRI/RA≥70
 ⌀ 120 ∇ 86



A2604AP-7BK

↓ 58 ↔ 6 ↗ 22
 ∅ 7W | LED, 350LM,
 4000K, CRI/RA≥70



A2604AP-7GO

↓ 58 ↔ 6 ↗ 22
 ∅ 7W | LED, 350LM,
 4000K, CRI/RA≥70



A2124SP-1BK

↓ 55 ↔ 11 ↗ 2,3
 ∅ 8W | LED, 400LM,
 4000K, CRI/RA≥80
 ⌀ 100 ∇ 7



multi-fastening -
 мультикрепление
 (2 вида)

Fixture material: metal painted
 Fixture colour: black
 Shade material: glass
 Shade colour: white

Материал арматуры: металл
 крашенный
 Цвет арматуры: черный
 Материал плафона: стекло
 Цвет плафона: белый

FURUD



A2125AP-1BK

↓ 5 ↔ 20 ∅ 11
 ∅ 6W | LED, 300LM,
 4000K, CRI/RA≥80



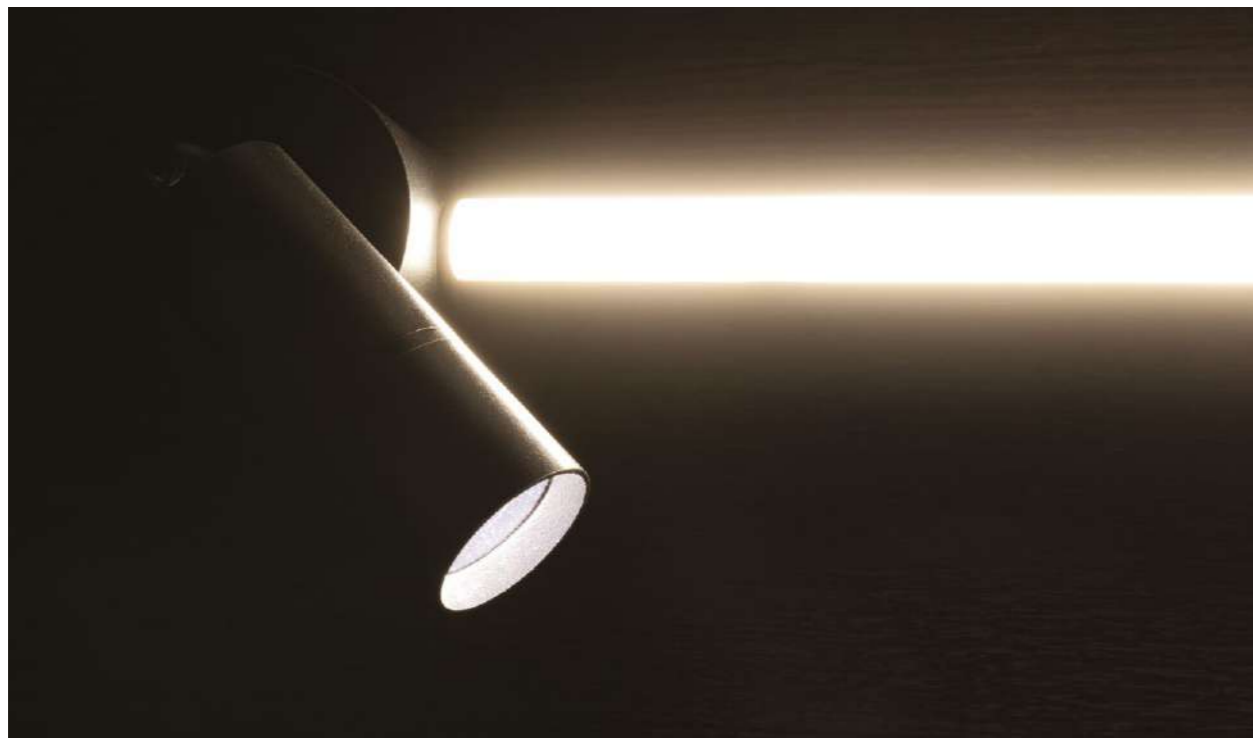

NEW

A2219PL-2BK

↑ 19 ↔ 6 ↗ 63
 ♀ 16W | LED, 760LM, 4000K,
 CRI/RA≥80



Fixture material: metal painted
 Fixture colour: black
 Shade material: acrylic
 Shade colour: white

Материал арматуры: металл крашенный
 Цвет арматуры: черный
 Материал плафона: акрил
 Цвет плафона: белый

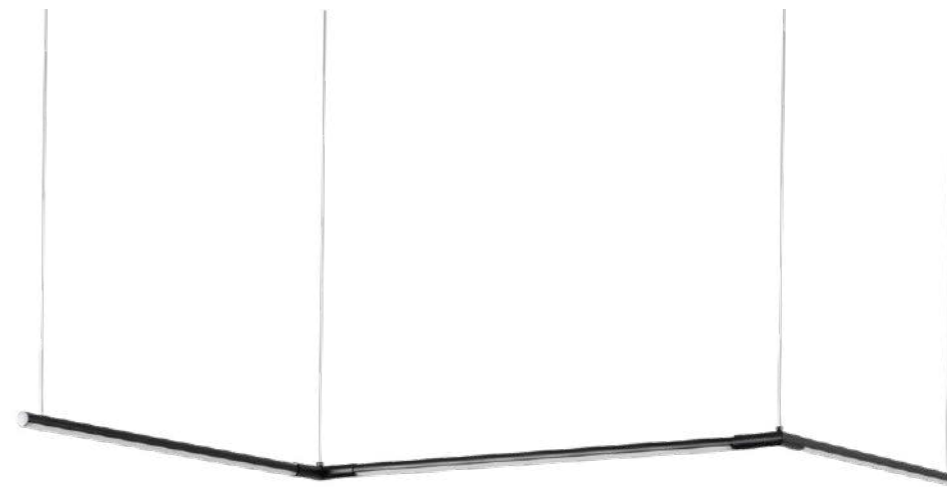

A2193SP-36BK

↑ 2 ↔ 202
 ♀ 20W | LED, 600LM, 2700-6500K,
 CRI/RA≥80
 ⌀ 120 ♀ 12



Fixture material: metal painted
 Fixture colour: black
 Shade material: acrylic
 Shade colour: white

Материал арматуры: металл крашенный
 Цвет арматуры: черный
 Материал плафона: акрил
 Цвет плафона: белый

FANTASY





A2565SP-1PB

↓ 50 ∅ 40
 ♀ 12W | LED, 600LM,
 4000K, CRI/RA≥80
 ⚙ 100 ∇ 10



Fixture material: metal plated /
 metal painted
 Fixture colour: polished brass /
 black
 Shade colour: white

Материал арматуры: металл
 гальванизированный / металл
 крашенный
 Цвет арматуры: полированная медь
 / черный
 Цвет плафона: белый

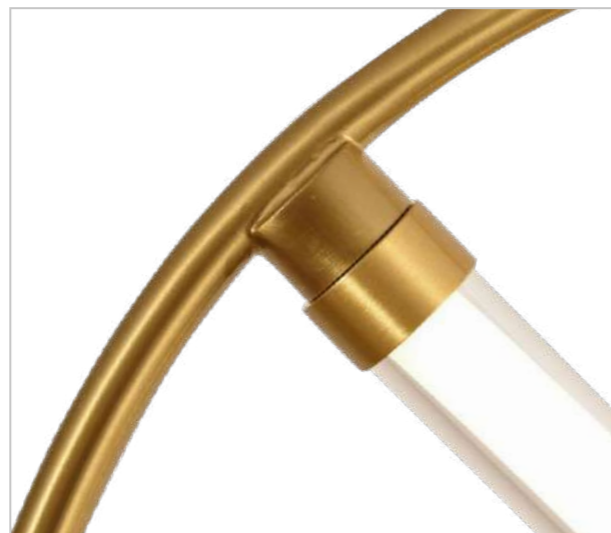

NEW

A2565SP-1BK

↓ 50 ∅ 40
 ♀ 12W | LED, 600LM, 4000K,
 CRI/RA≥80
 ⚙ 100 ∇ 10



A3220SP-1PB

↓ 20 ∅ 20
 ♀ 5W | LED, 350LM,
 4000K, CRI/RA≥80
 ⚙ 150 ∇ 10



A3225SP-1PB

↓ 25 ∅ 25
 ♀ 7W | LED, 490LM,
 4000K, CRI/RA≥80
 ⚙ 150 ∇ 10



A3230SP-1PB

↓ 30 ∅ 30
 ♀ 8W | LED, 560LM,
 4000K, CRI/RA≥80
 ⚙ 150 ∇ 10



HOLLY



Fixture material: metal plated
 Fixture colour: polished brass
 Shade material: plastic / glass
 Shade colour: amber

Материал арматуры: металл
 гальванизированный
 Цвет арматуры: полированная медь
 Материал плафона: пластик / стекло
 Цвет плафона: янтарный



NEW

A1916SP-1BK

↑ 27 ↔ 18
 ∅ 10W | LED, 500LM,
 4000K, CRI/RA≥80
 ⌀ 120 ∇ 10



Fixture material: metal plated
 Fixture colour: chrome / gold / black
 Shade material: acrylic
 Shade colour: white

Материал арматуры: металл
 гальванизированный
 Цвет арматуры: хром / золото /
 черный
 Цвет плафона: белый



A1916SP-1CC

↑ 27 ↔ 18
 ∅ 10W | LED, 500LM,
 4000K, CRI/RA≥80
 ⌀ 120 ∇ 10



A1916SP-1GO

↑ 27 ↔ 18
 ∅ 10W | LED, 500LM,
 4000K, CRI/RA≥80
 ⌀ 120 ∇ 10



A2191SP-18BK

↑ 65 ↔ 6 ∇ 55
 ∅ 18W | LED, 720LM,
 4000K, CRI/RA≥80
 ⌀ 55 ∇ 55X6



A2191SP-18PB

↑ 65 ↔ 6 ∇ 55
 ∅ 18W | LED, 720LM,
 4000K, CRI/RA≥80
 ⌀ 55 ∇ 55X6



A2191SP-6BK

↑ 65 ∅ 5
 ∅ 6W | LED, 225LM,
 4000K, CRI/RA≥80
 ⌀ 55 ∇ 12



A2191SP-6PB

↑ 65 ∅ 5
 ∅ 6W | LED, 225LM,
 4000K, CRI/RA≥80
 ⌀ 55 ∇ 12



FRANKIE



Fixture material: metal painted / metal plated
 Fixture colour: black / polished brass
 Shade material: acrylic
 Shade colour: white

Материал арматуры: металл крашенный /
 металл гальванизированный
 Цвет арматуры: черный / полированная медь
 Материал плафона: акрил
 Цвет плафона: белый



NEW
A1134SP-7PB

↓ 18 ∅8
 ♀ 7W | LED, 350LM,
 4000K, CRI/RA≥80
 ⌀ 140 ∇ 7



NEW
A1134SP-7BK

↓ 18 ∅8
 ♀ 7W | LED, 350LM,
 4000K, CRI/RA≥80
 ⌀ 140 ∇ 7



A2034SP-1BK

↓ 46 ∅12
 ♀ 10W | LED, 400LM,
 4000K, CRI/RA≥80
 ⌀ 150 ∇ 14



A2034SP-1WH

↓ 46 ∅12
 ♀ 10W | LED, 400LM,
 4000K, CRI/RA≥80
 ⌀ 150 ∇ 14



ASCELLA



Fixture material: metal plated
 Fixture colour: black / brass
 Shade material: plastic
 Shade colour: clear

Материал арматуры: металл
 гальванизированный
 Цвет арматуры: черный / латунь
 Материал плафона: пластик
 Цвет плафона: прозрачный

Fixture material: stone
 Fixture colour: white / black
 Материал арматуры: камень
 Цвет арматуры: белый / черный





NEW
A2306SP-6GO

↓ 28 ∅ 14
 ♀ 6W | LED, 300LM,
 4000K, CRI/RA≥80
 ⚙ 90 ∇ 12



NEW
A2404SP-23SM

↓ 34 ∅ 23
 ♀ 12W | LED, 600LM,
 4000K, CRI/RA≥80
 ⚙ 100 ∇ 14



NEW
A2404SP-33SM

↓ 28 ∅ 33
 ♀ 12W | LED, 600LM,
 4000K, CRI/RA≥80
 ⚙ 100 ∇ 14



NEW
A2404LT-1SM

↓ 58 ∅ 33
 ♀ 12W | LED, 600LM,
 4000K, CRI/RA≥80



Fixture material: metal plated
 Fixture colour: gold
 Shade material: glass
 Shade colour: clear

Материал арматуры: металл
 гальванизированный
 Цвет арматуры: золото
 Материал плафона: стекло
 Цвет плафона: прозрачный



NEW
A2404SP-23AM

↓ 34 ∅ 23
 ♀ 12W | LED, 600LM,
 4000K, CRI/RA≥80
 ⚙ 100 ∇ 14



NEW
A2404SP-33AM

↓ 28 ∅ 33
 ♀ 12W | LED, 600LM,
 4000K, CRI/RA≥80
 ⚙ 100 ∇ 14



NEW
A2404LT-1AM

↓ 58 ∅ 33
 ♀ 12W | LED, 600LM,
 4000K, CRI/RA≥80



Fixture material: metal plated
 Fixture colour: amber / smoky
 Shade material: glass
 Shade colour: amber / smoky

Материал арматуры: металл
 гальванизированный
 Цвет арматуры: янтарный / дымчатый
 Материал плафона: стекло
 Цвет плафона: янтарный / дымчатый



NEW

A6835SP-12SM

↑ 60 ∅ 16
 ♀ 12W | LED, 600LM,
 3500K, CRI/RA≥80
 ⚙ 60 ∇ 16



NEW

A6835SP-12AM

↑ 60 ∅ 16
 ♀ 12W | LED, 600LM,
 3500K, CRI/RA≥80
 ⚙ 60 ∇ 16



Fixture material: metal painted
 Fixture colour: black
 Shade material: glass
 Shade colour: smoky / amber
 Материал арматуры: металл крашенный
 Цвет арматуры: черный
 Материал плафона: стекло
 Цвет плафона: дымчатый / янтарный



A2563AP-1PB

↑ 65 ↔ 11 ↗ 25
 ♀ 12W | LED, 600LM,
 4000K, CRI/RA≥80



A2564AP-1PB

↑ 65 ↔ 11 ↗ 25
 ♀ 12W | LED, 600LM,
 4000K, CRI/RA≥80



Fixture material: metal plated
 Fixture colour: polished brass
 Shade material: crystal
 Shade colour: clear

Материал арматуры: металл гальванизированный
 Цвет арматуры: полированная медь
 Материал плафона: хрусталь
 Цвет плафона: прозрачный

ALMAAZ

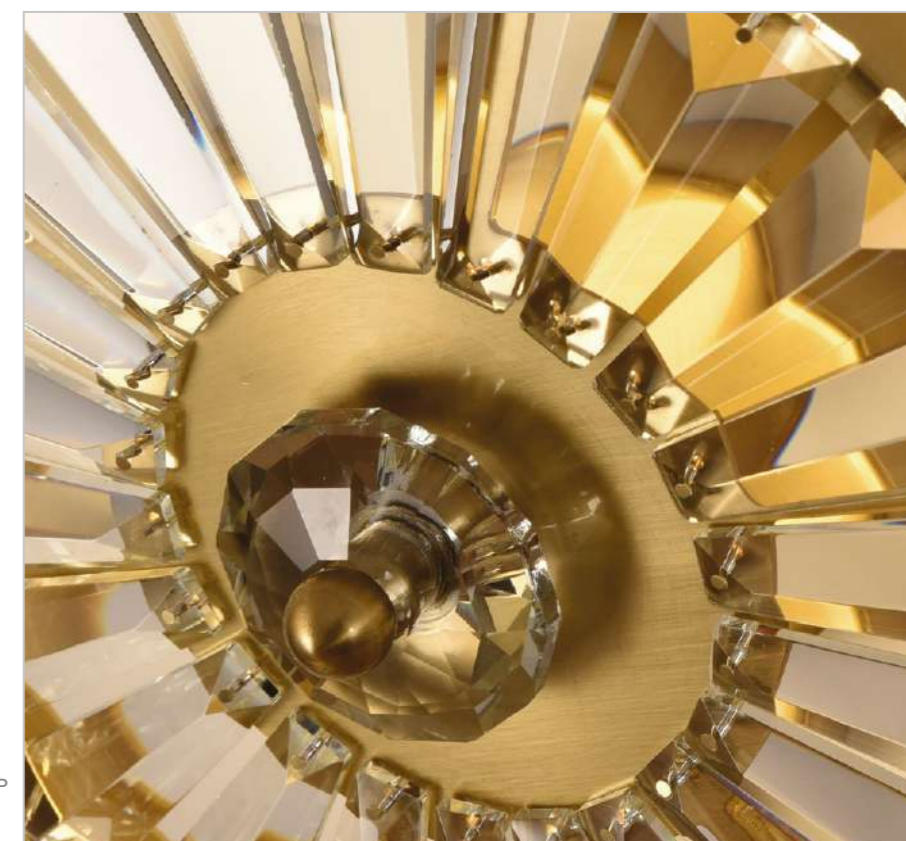



NEW
A6839SP-12SM

↓ 60 Ø 16
 ♀ 12W | LED, 600LM,
 3500K, CRI/RA≥80
 ⌀ 60 ∇ 16



NEW
A6839SP-12CL

↓ 60 Ø 16
 ♀ 12W | LED, 600LM,
 3500K, CRI/RA≥80
 ⌀ 60 ∇ 16



NEW
A6839SP-12AM

↓ 60 Ø 16
 ♀ 12W | LED, 600LM,
 3500K, CRI/RA≥80
 ⌀ 60 ∇ 16



NEW
A6837SP-12SM

↓ 60 Ø 16
 ♀ 12W | LED, 600LM,
 3500K, CRI/RA≥80
 ⌀ 60 ∇ 16



NEW
A6837SP-12CL

↓ 60 Ø 16
 ♀ 12W | LED, 600LM,
 3500K, CRI/RA≥80
 ⌀ 60 ∇ 16



NEW
A6837SP-12AM

↓ 60 Ø 16
 ♀ 12W | LED, 600LM,
 3500K, CRI/RA≥80
 ⌀ 60 ∇ 16



NEW
A6840SP-12SM

↓ 60 Ø 16
 ♀ 12W | LED, 600LM,
 3500K, CRI/RA≥80
 ⌀ 60 ∇ 16

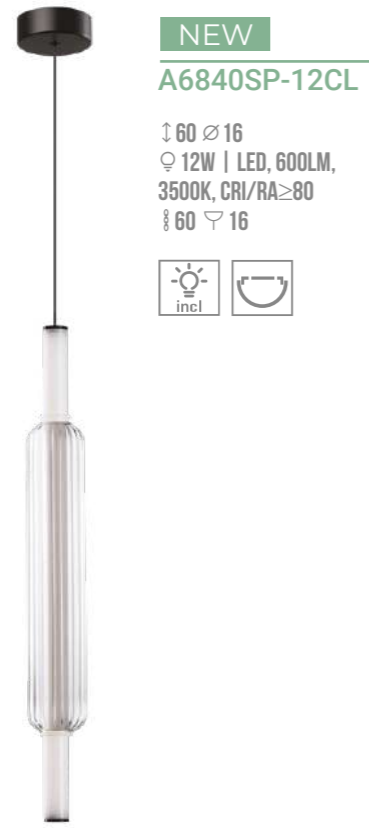

NEW
A6840SP-12CL

↓ 60 Ø 16
 ♀ 12W | LED, 600LM,
 3500K, CRI/RA≥80
 ⌀ 60 ∇ 16



NEW
A6840SP-12AM

↓ 60 Ø 16
 ♀ 12W | LED, 600LM,
 3500K, CRI/RA≥80
 ⌀ 60 ∇ 16



NEW
A6838SP-12SM

↓ 60 Ø 16
 ♀ 12W | LED, 600LM,
 3500K, CRI/RA≥80
 ⌀ 60 ∇ 16



NEW
A6838SP-12CL

↓ 60 Ø 16
 ♀ 12W | LED, 600LM,
 3500K, CRI/RA≥80
 ⌀ 60 ∇ 16



NEW
A6838SP-12AM

↓ 60 Ø 16
 ♀ 12W | LED, 600LM,
 3500K, CRI/RA≥80
 ⌀ 60 ∇ 16



Fixture material: metal painted
 Fixture colour: black
 Shade material: glass, pla
 Shade colour: smoky / clear / amber

Материал арматуры: металл крашенный
 Цвет арматуры: черный
 Материал плафона: стекло
 Цвет плафона: дымчатый / прозрачный / янтарный

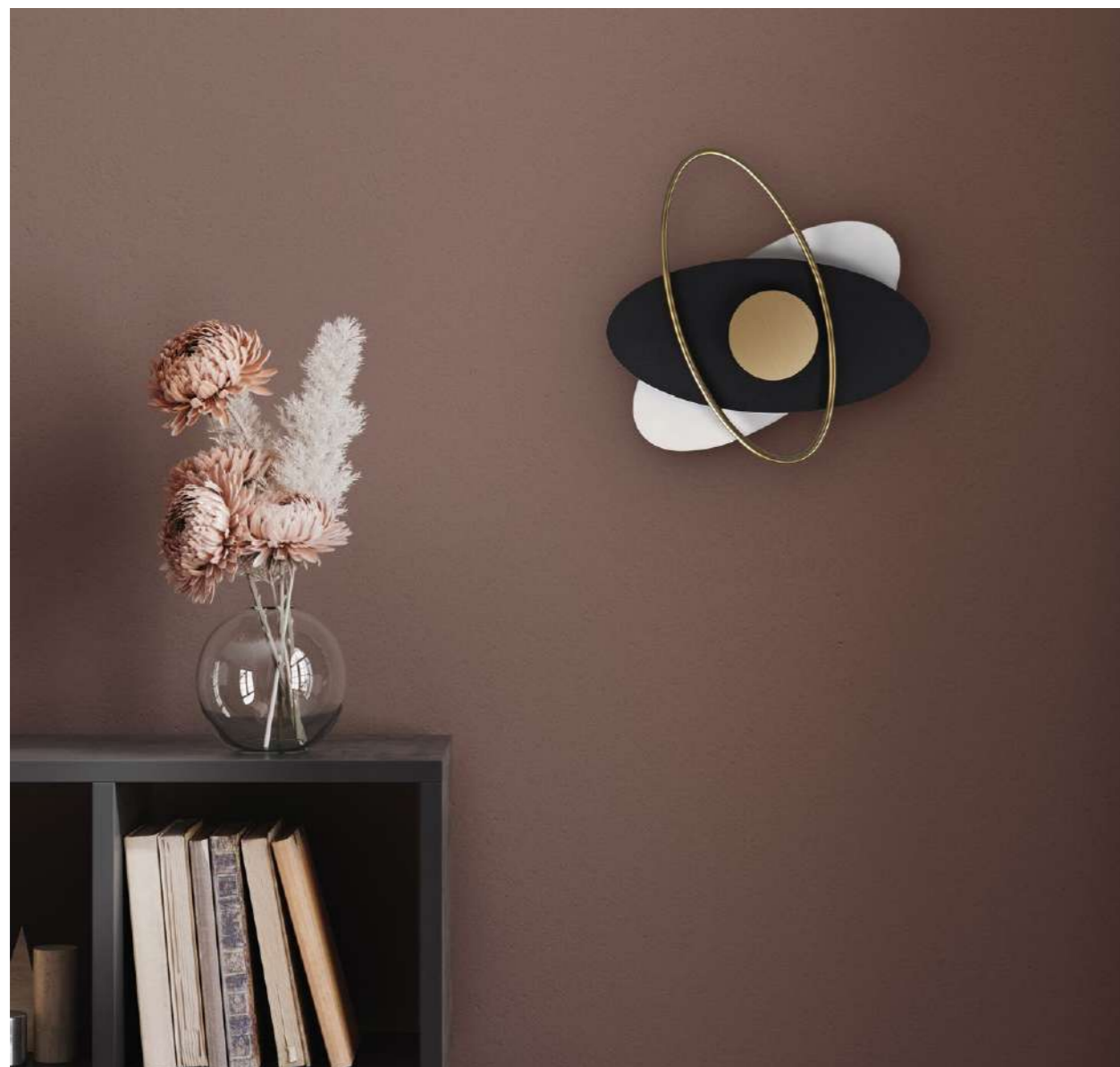

A2605AP-7BK

↑ 26 ↔ 6 ↗ 27
 ♀ 7W | LED, 350LM,
 4000K, CRI/RA≥70



Fixture material: metal painted
 Fixture colour: black
 Shade material: acrylic
 Shade colour: white

Материал арматуры: металл
 крашенный
 Цвет арматуры: черный
 Материал плафона: акрил
 Цвет плафона: белый



NEW A2641AP-1GO

↑ ∅30
 ♀ 10W | LED, 500LM,
 4000K, CRI/RA≥80
 ∇ 12



NEW A2643AP-1GO

↑ ∅30
 ♀ 10W | LED, 100LM,
 4000K, CRI/RA≥80
 ∇ 12



NEW A2642AP-1GO

↑ ∅30
 ♀ 10W | LED, 500LM,
 4000K, CRI/RA≥80
 ∇ 12



NEW A2644AP-1GO

↑ ∅30
 ♀ 10W | LED, 500LM,
 4000K, CRI/RA≥80
 ∇ 12



Fixture material: metal plated
 Fixture colour: gold
 Shade material: acrylic
 Shade colour: clear

Материал арматуры: металл
 гальванизированный
 Цвет арматуры: золото
 Материал плафона: акрил
 Цвет плафона: прозрачный



NEW A2640AP-1GO

↑ 54 ↔ 14 ↗ 8
 ♀ 6W | LED, 300LM,
 4000K, CRI/RA≥80
 ∇ 8



BISCOTTO





A2135AP-1PB

↑ 50 ↔ 7 ↗ 14
 ♀ 16W | LED, 800LM,
 4000K, CRI/RA≥80



A2136AP-1PB

↑ 50 ↔ 5 ↗ 14
 ♀ 14W | LED, 700LM,
 4000K, CRI/RA≥80



Fixture material: metal plated
 Fixture colour: polished brass
 Shade material: artificial stone
 Shade colour: white

Материал арматуры: металл
 гальванизированный
 Цвет арматуры: полированная медь
 Материал плафона: искусственный камень
 Цвет плафона: белый

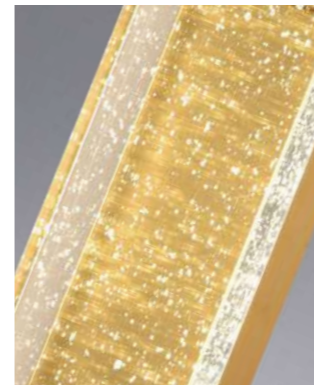

Fixture material: metal plated
 Fixture colour: gold
 Shade material: crystal
 Shade colour: clear

Материал арматуры: металл
 гальванизированный
 Цвет арматуры: золото
 Материал плафона: хрусталь
 Цвет плафона: прозрачный



A2133AP-1GO

↑ 39 ↔ 7 ↗ 10
 ♀ 6W | LED, 300LM,
 4000K, CRI/RA≥80



SNOWDROP





A2033AP-1BK

↓ 20 ↔ 17 ↗ 9
 ⌀ 5W | LED, 200LM,
 4000K, CRI/RA≥80



A2033AP-1PB

↓ 20 ↔ 17 ↗ 9
 ⌀ 5W | LED, 200LM,
 4000K, CRI/RA≥80



A2033AP-1WH

↓ 20 ↔ 17 ↗ 9
 ⌀ 5W | LED, 200LM,
 4000K, CRI/RA≥80



Fixture material: metal plated / metal painted
 Fixture colour: polished brass / black / white

Материал арматуры: металл гальванизированный / металл крашенный
 Цвет арматуры: полированная медь / черный / белый



A2173AP-1BK

↓ 19 ↔ 18 ↗ 13
 ⌀ 5W | LED, 475LM,
 4000K, CRI/RA≥80



A2173AP-1PB

↓ 19 ↔ 18 ↗ 13
 ⌀ 5W | LED, 475LM,
 4000K, CRI/RA≥80



ALBERT



Fixture material: metal plated / metal painted
 Fixture colour: polished brass / black

Материал арматуры: металл
 гальванизированный / металл крашенный
 Цвет арматуры: полированная медь / черный



NEW
A2611PL-3BK
 ↓ ↔ 11 ↗ 80
 ♀ 11W | LED, 550LM,
 4000K, CRI/RA≥70



NEW
A2611PL-4BK
 ↓ ↔ 11 ↗ 100
 ♀ 16W | LED, 800LM,
 4000K, CRI/RA≥70



Fixture material: metal painted
 Fixture colour: black
 Shade material: plastic
 Shade colour: white

Материал арматуры: металл крашенный
 Цвет арматуры: черный
 Материал плафона: пластик
 Цвет плафона: белый



NEW
A2608PL-7BK
 ↓ ↔ 17 ↗ 100
 ♀ 16W | LED, 800LM,
 4000K, CRI/RA≥70



NEW
A2608PL-5BK
 ↓ 3 ↔ 17 ↗ 80
 ♀ 11W | LED, 550LM,
 4000K, CRI/RA≥70



ZOSMA



NEW
A2608AP-2BK
 ↓ 34 ↔ 12 ↗ 8
 ♀ 10W | LED, 500LM,
 4000K, CRI/RA≥70



Fixture material: metal painted
 Fixture colour: black
 Shade material: plastic
 Shade colour: white

Материал арматуры: металл крашенный
 Цвет арматуры: черный
 Материал плафона: пластик
 Цвет плафона: белый



A2172AP-2BK
 ↓ 60 ↔ 10 ↗ 15
 ♀ 5W | LED, 475LM,
 4000K, CRI/RA≥80



Fixture material: metal painted
 Fixture colour: black
 Shade material: glass
 Shade colour: white

Материал арматуры: металл крашенный
 Цвет арматуры: черный
 Материал плафона: стекло
 Цвет плафона: белый

JOSEPH

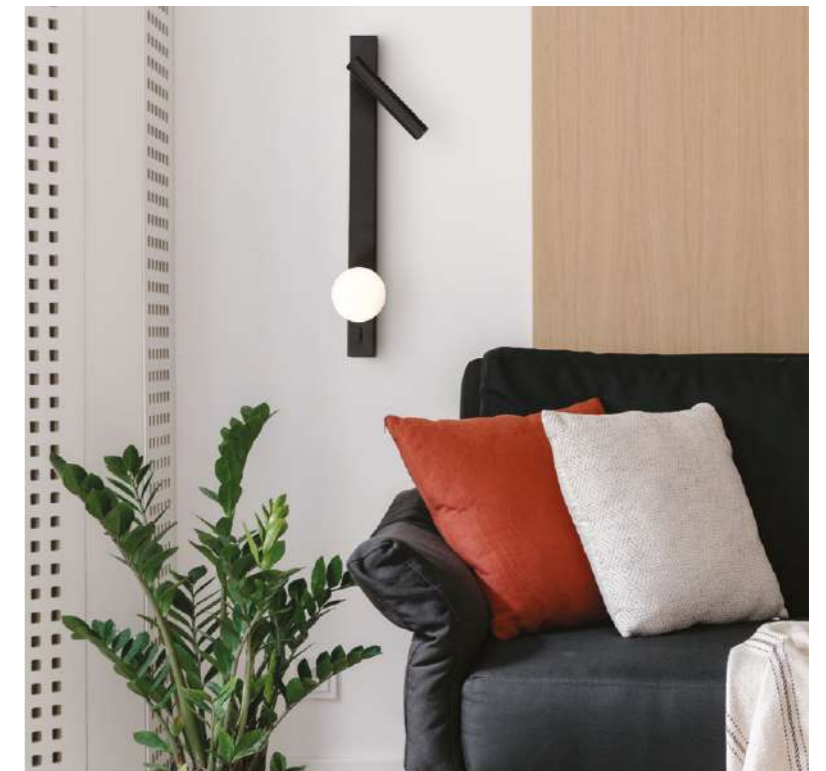



NEW
A2220PL-3WH
 ↓ 14 ↔ 4 ↗ 84
 ♀ 44W | LED, 4060LM,
 4000K, CRI/RA≥80



NEW
A2220PL-3GO
 ↓ 14 ↔ 4 ↗ 84
 ♀ 44W | LED, 3570LM,
 4000K, CRI/RA≥80



NEW
A2220PL-3BK
 ↓ 14 ↔ 4 ↗ 84
 ♀ 44W | LED, 4490LM,
 4000K, CRI/RA≥80



Fixture material: metal painted
 Fixture colour: white / black / gold
 Shade material: acrylic
 Shade colour: white

Материал арматуры: металл крашенный
 Цвет арматуры: белый / черный / золото
 Материал плафона: акрил
 Цвет плафона: белый



A2600PL-32GO
 ↓ 12 ↔ 6 ↗ 80
 ♀ 32W | LED, 1700LM,
 4000K, CRI/RA≥70



A2600PL-32BK
 ↓ 12 ↔ 6 ↗ 80
 ♀ 32W | LED, 1700LM,
 4000K, CRI/RA≥70



Fixture material: metal painted
 Fixture colour: black / gold / white
 Shade material: acrylic
 Shade colour: white

Материал арматуры: металл крашенный
 Цвет арматуры: черный / золото / белый
 Материал плафона: акрил
 Цвет плафона: белый



A2602AP-10BK
 ↓ 12 ↔ 5 ↗ 40
 ♀ 10W | LED, 500LM,
 4000K, CRI/RA≥70

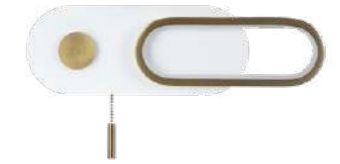

A2602AP-10WH
 ↓ 12 ↔ 5 ↗ 40
 ♀ 10W | LED, 500LM,
 4000K, CRI/RA≥70



LUCAS





A2607PL-22BK

↓ 10 ↔ 4 ↗ 60
 ∅ 22W | LED, 1100LM,
 4000K, CRI/RA≥70



A2607PL-22GO

↓ 10 ↔ 4 ↗ 60
 ∅ 22W | LED, 1100LM,
 4000K, CRI/RA≥70



A2607PL-30BK

↓ 10 ↔ 4 ↗ 80
 ∅ 30W | LED, 1500LM,
 3700K, CRI/RA≥70



A2607PL-30GO

↓ 10 ↔ 4 ↗ 80
 ∅ 30W | LED, 1500LM,
 4000K, CRI/RA≥70



A2607AP-20BK

∅ 25
 ∅ 20W | LED, 1000LM,
 4000K, CRI/RA≥70



A2607AP-20GO

∅ 25
 ∅ 20W | LED, 1000LM,
 4000K, CRI/RA≥70



Fixture material: metal painted
 Fixture colour: black / gold
 Shade material: acrylic
 Shade colour: white

Материал арматуры: металл крашенный
 Цвет арматуры: черный / золото
 Материал плафона: акрил
 Цвет плафона: белый





NEW
A2613SP-4BK

↓ 100 ↔ ↑ 120
 ∅ 54W | LED, 2700LM, 3000-5700K, CRI/RA≥70
 ∇ 20



NEW
A2613AP-2BK

↓ 30 ↔ 18 ∇ 22
 ∅ 21W | LED, 1050LM, 4000K, CRI/RA≥70



Fixture material: metal painted
 Fixture colour: black
 Shade material: acrylic
 Shade colour: white

Материал арматуры: металл крашенный
 Цвет арматуры: черный
 Материал плафона: акрил
 Цвет плафона: белый

SIENNA



A1363PL-6PB

↓ 42 ∅ 75
 ∅ 60W | LED, 3000LM, 3000-6400K, CRI/RA≥80
 ∇ 15



A1363PL-8PB

↓ 42 ∅ 102
 ∅ 80W | LED, 4000LM, 3000-6400K, CRI/RA≥80
 ∇ 15



Fixture material: metal plated
 Fixture colour: polished brass
 Shade material: plastic
 Shade colour: white

Материал арматуры: металл гальванизированный
 Цвет арматуры: полированная медь
 Материал плафона: пластик
 Цвет плафона: белый



A1364PL-8PB

↓ 34 ∅ 118
 ∅ 80W | LED, 4000LM, 3000-6400K, CRI/RA≥80
 ∇ 22



A1364PL-6PB

↓ 28 ∅ 105
 ∅ 60W | LED, 3000LM, 3000-6400K, CRI/RA≥80
 ∇ 20



Fixture material: metal plated
 Fixture colour: polished brass
 Shade material: plastic
 Shade colour: white

Материал арматуры: металл гальванизированный
 Цвет арматуры: полированная медь
 Материал плафона: пластик
 Цвет плафона: белый



A1364AP-2PB

↓ 48 ↔ 23 ∇ 6
 ∅ 16W | LED, 800LM, 3000K, CRI/RA≥80



HOLLY



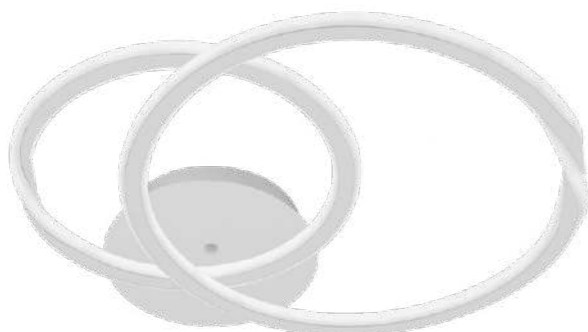

NEW

A2211PL-2WH

↓ 7 ↔ 50 ↗ 42
 ♀ 120W | LED, 6000LM,
 3000-6500K, CRI/RA≥80
 ∇ 20



Fixture material: metal painted
 Fixture colour: gold / black / white
 Shade material: acrylic / silicon
 Shade colour: white



NEW

A2211PL-2BK

↓ 7 ↔ 50 ↗ 42
 ♀ 120W | LED, 6000LM,
 3000-6500K, CRI/RA≥80
 ∇ 20



Материал арматуры: металл крашенный
 Цвет арматуры: золото / черный / белый
 Материал плафона: акрил / силикон
 Цвет плафона: белый

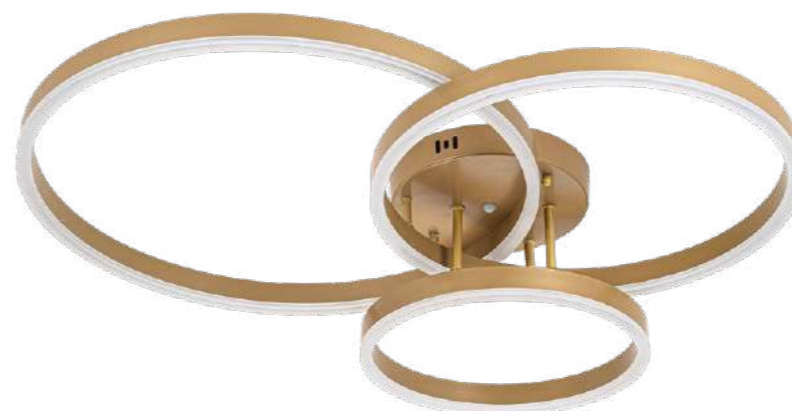

NEW

A2426PL-3GO

↓ 13 ↔ 70 ↗
 ♀ 85W | LED, 4250LM,
 3000-6500K, CRI/RA≥80
 ∇ 20



NEW

A2426PL-3BK

↓ 13 ↔ 70 ↗
 ♀ 85W | LED, 4250LM,
 3000-6500K, CRI/RA≥80
 ∇ 20



- remote control-пульт ДУ
- dimmer-диммирование
- color light change
 3000K-6500K - изменение
 цветовой температуры
 memory function-функция
 памяти





NEW
A2213AP-2WH

↓ 19 ↔ 9 ↗ 21
 ♀ 12W | LED, 600LM,
 4000K, CRI/RA≥70



NEW
A2213AP-2BK

↓ 19 ↔ 9 ↗ 21
 ♀ 12W | LED, 600LM,
 4000K, CRI/RA≥70



SYRMA



Fixture material: aluminum, silicone
 Fixture colour: black / white
 Shade material: aluminum
 Shade colour: black / white

Материал арматуры: алюминий,
 силикон
 Цвет арматуры: черный / белый
 Материал плафона: алюминий
 Цвет плафона: черный / белый



A2090SP-1BK

↓ 30 ∅ 3
 ♀ 3W | LED, 150LM,
 4000K, CRI/RA≥80
 ⌀ 150 ∇ 10



A2090SP-1PB

↓ 30 ∅ 3
 ♀ 3W | LED, 150LM,
 4000K, CRI/RA≥80
 ⌀ 150 ∇ 10



Fixture material: metal painted / metal plated
 Fixture colour: black / polished brass
 Shade colour: white

Материал арматуры: металл крашенный / металл
 гальванизированный
 Цвет арматуры: черный / полированная медь
 Цвет плафона: белый



BEEMIM





Creativiti

ОРИГИНАЛЬНЫЕ

все иллюстрации созданы инструментами нейросети
#Midjourney



NEW
A4073LM-7PB
↓ 30 ∅ 50
♀ 7X40W | E14
⌘ 70 ∇ 12



NEW
A4073LM-12PB
↓ 40 ∅ 60
♀ 12X40W | E14
⌘ 60 ∇ 12



NEW
A4078LM-12GO
↓ 44 ∅ 60
♀ 12X40W | E14
⌘ 52 ∇ 8



NEW
A4078LM-6GO
↓ 35 ∅ 45
♀ 6X40W | E14
⌘ 52 ∇ 8



NEW
A4073AP-2PB
↓ 20 ↔ 35 ↗ 20
♀ 2X40W | E14



Fixture material: metal plated
Fixture colour: polished brass
Shade material: glass
Shade colour: clear

Материал арматуры: металл
гальванизированный
Цвет арматуры: полированная медь
Материал плафона: стекло
Цвет плафона: прозрачный



NEW
A4078AP-2GO
↓ 35 ↔ 35 ↗ 16
♀ 2X40W | E14

Fixture material: metal plated
Fixture colour: gold
Shade material: glass
Shade colour: clear

Материал арматуры: металл
гальванизированный
Цвет арматуры: золото
Материал плафона: стекло
Цвет плафона: прозрачный



KAPRI



NEW
A4070LM-9GO

↑ 43 ∅ 61
♀ 9X40W | E14
⌘ 44 ∇ 14



NEW
A4070LM-12GO

↑ 54 ∅ 80
♀ 12X40W | E14
⌘ 40 ∇ 14



NEW
A4070AP-2GO

↑ 35 ↔ 27 ∇ 18
♀ 2X40W | E14

Fixture material: metal plated
Fixture colour: gold
Shade material: glass
Shade colour: white

Материал арматуры: металл
гальванизированный
Цвет арматуры: золото
Материал плафона: стекло
Цвет плафона: белый



NEW
A4080AP-2GO

↑ 30 ↔ 27 ∇ 16
♀ 2X40W | E14

Fixture material: metal plated
Fixture colour: gold
Shade material: glass
Shade colour: clear

Материал арматуры: металл
гальванизированный
Цвет арматуры: золото
Материал плафона: стекло
Цвет плафона: прозрачный



NEW
A4080LM-6GO

↑ 43 ∅ 45
♀ 6X40W | E14
⌘ 52 ∇ 8



NEW
A4080LM-12GO

↑ 52 ∅ 60
♀ 12X40W | E14
⌘ 52 ∇ 8



FELICITA



NEW

A4077AP-2GO

↓ 30 ↔ 35 ↗ 18
 ♀ 2X40W | E14



NEW

A4077LM-10GO

↓ 42 ∅ 60
 ♀ 10X40W | E14
 ⚙ 52 ∇ 8



NEW

A4077LM-6GO

↓ 35 ∅ 47
 ♀ 6X40W | E14
 ⚙ 52 ∇ 8



NEW

A4077SP-7GO

↓ 22 ∅ 60
 ♀ 7X40W | E14
 ⚙ 80 ∇ 12



NEW

A4077SP-10GO

↓ 22 ∅ 80
 ♀ 10X40W | E14
 ⚙ 80 ∇ 12



Fixture material: metal plated
 Fixture colour: gold
 Shade material: glass
 Shade colour: clear

Материал арматуры: металл
 гальванизированный
 Цвет арматуры: золото
 Материал плафона: стекло
 Цвет плафона: прозрачный





NEW
A4074AP-2CC
 ↓ 26 ↔ 37 ↗ 15
 ♀ 2X40W | E14



NEW
A4074LM-10CC
 ↓ 26 ∅ 60
 ♀ 10X40W | E14
 ⚙ 70 ∇ 12



NEW
A4074SP-12CC
 ↓ 26 ↔ 25 ↗ 120
 ♀ 12X40W | E14
 ⚙ 70



NEW
A4074LM-14CC
 ↓ 26 ∅ 80
 ♀ 14X40W | E14
 ⚙ 70 ∇ 12



Fixture material: metal plated
 Fixture colour: chrome
 Shade material: glass
 Shade colour: прозрачный

Материал арматуры: металл
 гальванизированный
 Цвет арматуры: хром
 Материал плафона: стекло
 Цвет плафона: прозрачный

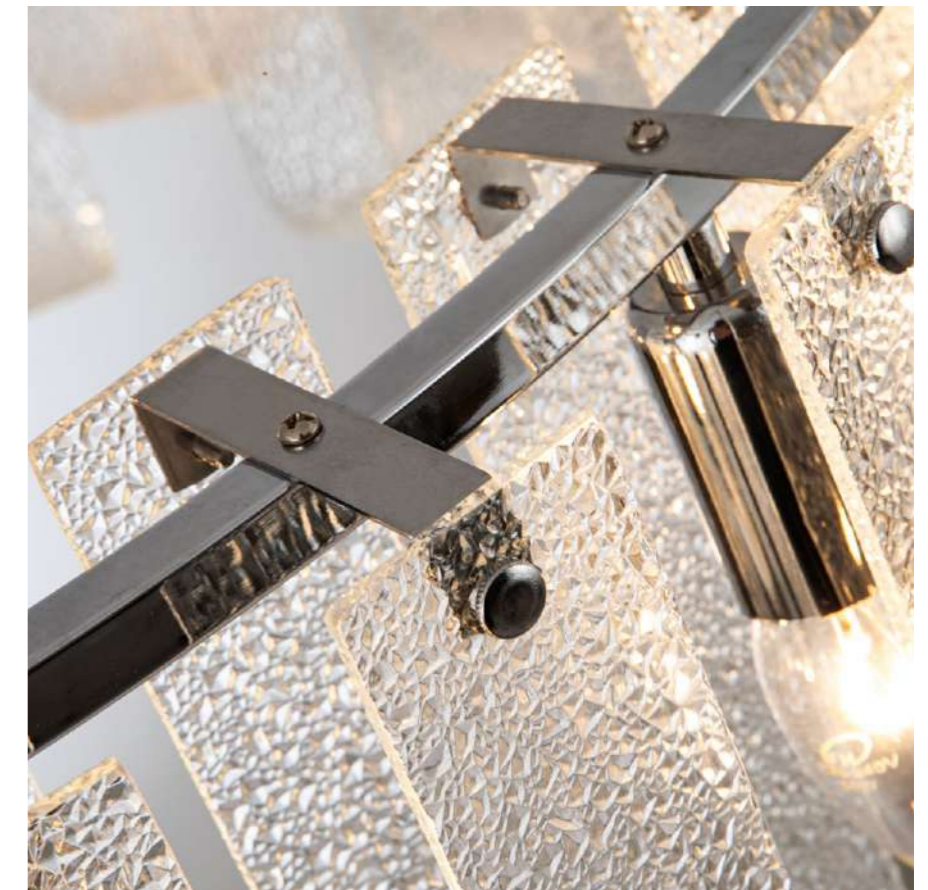



NEW
A4072LM-6GO

↓ 39 ∅ 52
♀ 6X40W | E14
⌘ 45 ∇ 14



NEW
A4072LM-9GO

↓ 45 ∅ 62
♀ 9X40W | E14
⌘ 45 ∇ 14



NEW
A4072AP-2GO

↓ 43 ↔ 33 ↗ 22
♀ 2X40W | E14



Fixture material: metal plated
Fixture colour: gold
Shade material: glass
Shade colour: white

Материал арматуры: металл
гальванизированный
Цвет арматуры: золото
Материал плафона: стекло
Цвет плафона: белый



NEW
A4068LM-7SG

↓ 37 ∅ 45
♀ 7X40W | E14
⌘ 52 ∇ 12



NEW
A4068LM-12SG

↓ 37 ∅ 59
♀ 12X40W | E14
⌘ 52 ∇ 12



NEW
A4068AP-3SG

↓ 34 ↔ 36 ↗ 19
♀ 3X40W | E14

Fixture material: metal painted
Fixture colour: matt gold
Shade material: glass
Shade colour: white

Материал арматуры: металл крашенный
Цвет арматуры: матовое золото
Материал плафона: стекло
Цвет плафона: белый

THEEMIN



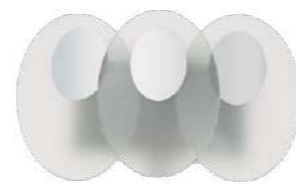

A4067AP-2CC

↓ 18 ↔ 12 ↗ 30
 ♀ 2X40W | E14



NEW

A4069LM-7AB

↓ 37 ∅ 44
 ♀ 7X40W | E14
 ⚙ 52 ∇ 12



NEW

A4069LM-13AB

↓ 46 ∅ 60
 ♀ 13X40W | E14
 ⚙ 52 ∇ 12



A4067LM-11CC

↓ 55 ∅ 66
 ♀ 140W | E14
 ⚙ 60 ∇ 12



A4067LM-7CC

↓ 40 ∅ 52
 ♀ 7X40W | E14
 ⚙ 60 ∇ 12



NEW

A4069AP-2AB

↓ 29 ↔ 28 ↗ 13
 ♀ 2X40W | E14

Fixture material: metal plated
 Fixture colour: antique bronze
 Shade material: glass
 Shade colour: white

Материал арматуры: металл крашенный
 Цвет арматуры: античная бронза
 Материал плафона: стекло
 Цвет плафона: белый

Fixture material: metal plated
 Fixture colour: chrome
 Shade material: glass
 Shade colour: white

Материал арматуры: металл гальванизированный
 Цвет арматуры: хром
 Материал плафона: стекло
 Цвет плафона: белый

LAMBRUSCO

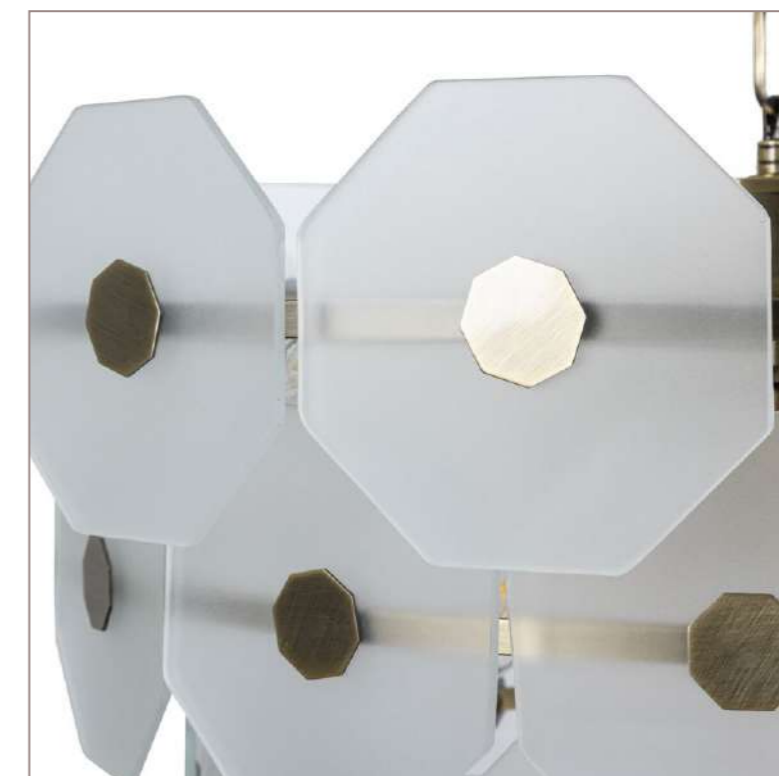



A4066LM-6PB

↑ 46 ∅ 52
 ♀ 6X40W | E14
 ⚙ 60 ∇ 12



A4066LM-11PB

↑ 55 ∅ 66
 ♀ 140W | E14
 ⚙ 60 ∇ 12



A4066AP-2PB

↑ 21 ↔ 11 ↗ 30
 ♀ 2X40W | E14



Fixture material: metal plated
 Fixture colour: polished brass
 Shade material: glass
 Shade colour: amber

Материал арматуры: металл
 гальванизированный
 Цвет арматуры:
 полированная медь
 Материал плафона: стекло
 Цвет плафона: янтарный





A4052SP-1SG

↓ 30 ∅ 25
 ♀ 60W | E27
 ⚙ 120 ∇ 10



A4052SP-12SG

↓ 22 ∅ 80
 ♀ 12X40W | E14
 ⚙ 78 ∇ 12



A4052AP-2SG

↓ 31 ↔ 26 ↗ 16
 ♀ 2X40W | E14



A4052SP-8SG

↓ 22 ∅ 60
 ♀ 8X40W | E14
 ⚙ 78 ∇ 12



A4152SP-8SG

↓ 21 ↔ 38 ↗ 80
 ♀ 8X40W | E14
 ⚙ 80



A4052LM-6SG

↓ 39 ∅ 43
 ♀ 6X40W | E14
 ⚙ 52 ∇ 10



A4052LM-12SG

↓ 48 ∅ 58
 ♀ 12X40W | E14
 ⚙ 53 ∇ 12



Fixture material: metal painted
 Fixture colour: matt gold
 Shade material: glass

Материал арматуры: металл крашенный
 Цвет арматуры: матовое золото
 Материал плафона: стекло





A4041SP-5CC

↓ 24 ∅ 45
 ∅ 5X40W | E14
 ⌘ 31 ∇ 12



A4041SP-8CC

↓ 24 ∅ 60
 ∅ 8X40W | E14
 ⌘ 31 ∇ 12



A4041AP-2CC

↓ 25 ↔ 18 ∇ 12
 ∅ 2X40W | E14



A4065AP-2SG

↓ 36 ↔ 23 ∇ 12
 ∅ 2X40W | E14

Fixture material: metal painted / metal plated
 Fixture colour: matt gold / chrome
 Shade material: crystal, pearl
 Материал арматуры: металл крашенный / металл гальванизированный
 Цвет арматуры: матовое золото / хром
 Материал плафона: хрусталь, перламутр



A4065SP-9SG

↓ 46 ∅ 60
 ∅ 9X40W | E14
 ⌘ 45 ∇ 12



A4065SP-6SG

↓ 46 ∅ 50
 ∅ 6X40W | E14
 ⌘ 46 ∇ 12





A2848AP-2GO

↑ 29 ↔ 15 ↘ 24
 ∅ 2X40W | E14

Fixture material: metal plated
 Fixture colour: gold
 Shade material: crystal
 Shade colour: clear

Материал арматуры: металл
 гальванизированный
 Цвет арматуры: золото
 Материал плафона: хрусталь
 Цвет плафона: прозрачный



A2848LM-8GO

↑ 35 ∅ 57
 ∅ 8X40W | E14
 ⌈ 110 ∟ 12



A2848SP-5GO

↑ 29 ↔ 34 ↘ 63
 ∅ 5X40W | E14
 ⌈ 90 ∟ 18X7



A2848SP-3GO

↑ 26 ∅ 44
 ∅ 3X40W | E14
 ⌈ 90 ∟ 12



A2848PL-5GO

↑ 34 ∅ 50
 ∅ 5X40W | E14
 ∟ 16



A2848SP-8GO

↑ 25 ∅ 60
 ∅ 8X40W | E14
 ⌈ 70 ∟ 12





A1059SP-6CC

↓ 21 ↔ 30 ↗ 80
 ∅ 6X40W | E14
 ⚡ 85



A1059SP-9CC

↓ 35 ∅ 60
 ∅ 9X40W | E14
 ⚡ 65 ∇ 10



A1059AP-2CC

↓ 15 ↔ 15 ↗ 35
 ∅ 2X40W | E14

Fixture material: metal plated
 Fixture colour: chrome
 Shade material: glass
 Shade colour: clear

Материал арматуры: металл
 гальванизированный
 Цвет арматуры: хром
 Материал плафона: стекло
 Цвет плафона: прозрачный



A1059SP-1CC

↓ 26 ∅ 17
 ∅ 60W | E27
 ⚡ 94



A1059AP-1CC

↓ 26 ↔ 18 ↗ 12
 ∅ 60W | E27



A7410PL-24CC

↑ 50 ∅ 60
 ♀ 24X3W | G4
 ∇ 15



A7410AP-4CC

↑ 30 ↔ 8 ↗ 10
 ♀ 4X3W | G4
 ∇ 10



A7410PL-24PB

↑ 50 ∅ 65
 ♀ 24X3W | G4
 ∇ 15



A7410PL-40PB

↑ 60 ∅ 95
 ♀ 40X3W | G4
 ∇ 15



A7410AP-4PB

↑ 30 ↔ 8 ↗ 10
 ♀ 4X3W | G4
 ∇ 10



Fixture material: metal plated
 Fixture colour: polished brass / chrome
 Shade material: acrylic / plastic
 Shade colour: white

Материал арматуры: металл гальванизированный
 Цвет арматуры: полированная медь / хром
 Материал плафона: акрил / пластик
 Цвет плафона: белый



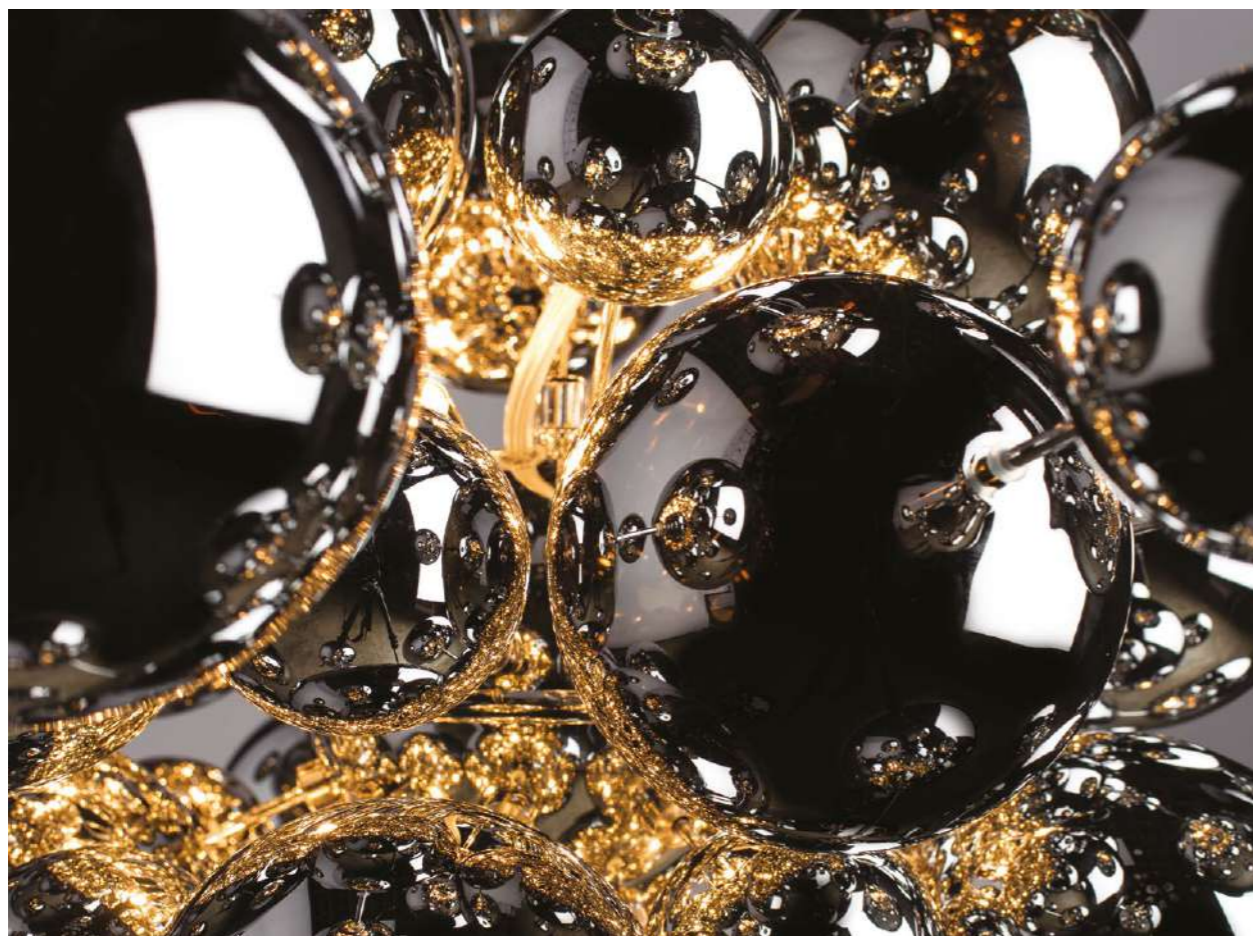

A8313PL-5CC

↓ 33 ∅ 60
 ♀ 5X40W | G9
 ∇ 14

Fixture material: metal plated / metal painted
 Fixture colour: chrome / gold
 Shade material: glass
 Shade colour: chrome / amber
 Материал арматуры: металл гальванизированный / металл крашеный
 Цвет арматуры: хром / золото
 Материал плафона: стекло
 Цвет плафона: хром / янтарный



A8313SP-9CC

↓ 60 ∅ 60
 ♀ 9X40W | G9
 ⌘ 100 ∇ 12



A8313SP-6CC

↓ 52 ∅ 52
 ♀ 6X40W | G9
 ⌘ 100 ∇ 12



A8313PL-5GO

↓ 33 ∅ 60
 ♀ 5X40W | G9
 ∇ 14



A8313SP-9GO

↓ 60 ∅ 60
 ♀ 9X40W | G9
 ⌘ 100 ∇ 12



A8313SP-6GO

↓ 52 ∅ 52
 ♀ 6X40W | G9
 ⌘ 100 ∇ 12





A2995LM-8CC

↓ 52 ∅ 70
 ♀ 8X40W | E14
 ⚡ 70 ∇ 12



Fixture material: metal plated
 Fixture colour: chrome
 Shade material: glass
 Shade colour: smoky

Материал арматуры: металл гальванизированный
 Цвет арматуры: хром
 Материал плафона: стекло
 Цвет плафона: дымчатый



A4207PL-9CC

↓ 23 ∅ 50
 ♀ 9X40W | G9
 ∇ 28



A4207AP-2CC

↓ 22 ↔ 11 ↗ 22
 ♀ 2X40W | G9



A4207SP-4CC

↓ 25 ∅ 40
 ♀ 4X40W | G9
 ⚡ 100 ∇ 12



Fixture material: metal plated
 Fixture colour: chrome
 Shade material: metal plated, glass
 Shade colour: chrome

Материал арматуры: металл гальванизированный
 Цвет арматуры: хром
 Материал плафона: металл, стекло
 Цвет плафона: хром

INCANTO

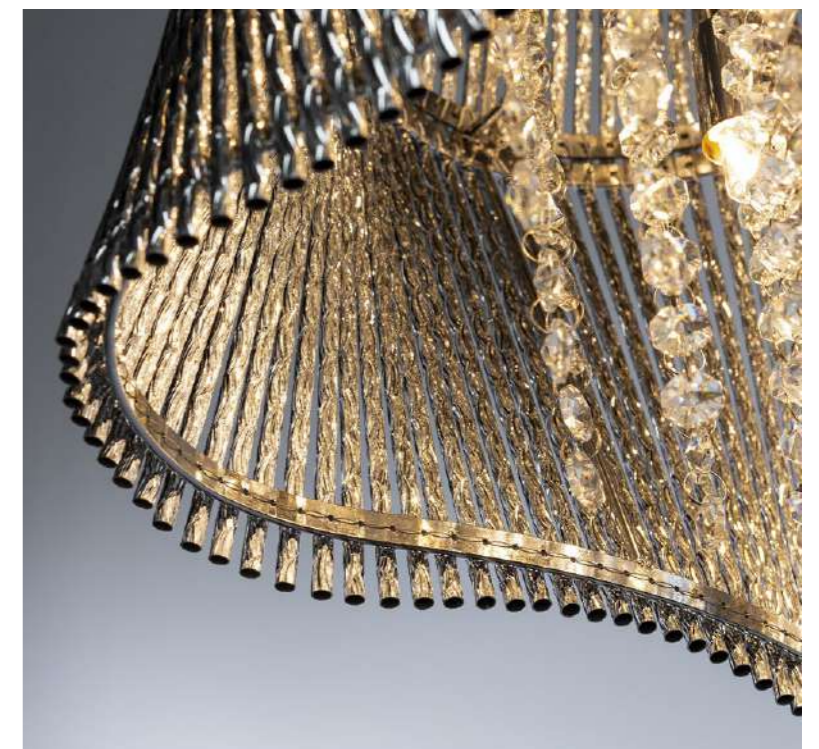



A3479SP-1CC

↓ 30 ∅ 20
 ♀ 40W | E27
 ⚙ 100 ∇ 12



A3479PL-9CC

↓ 25 ∅ 65
 ♀ 9X40W | E27
 ∇ 60



A3479PL-5CC

↓ 27 ∅ 51
 ♀ 5X40W | E27
 ∇ 35



A3479PL-3CC

↓ 27 ∅ 42
 ♀ 3X40W | E27
 ∇ 25



A3479PL-1CC

↓ 25 ∅ 20
 ♀ 40W | E27
 ∇ 12

Fixture material: metal painted / metal plated
 Fixture colour: chrome / antique bronze
 Shade material: glass
 Shade colour: white

Материал арматуры: металл крашенный / металл гальванизированный
 Цвет арматуры: хром / античная бронза
 Материал плафона: стекло
 Цвет плафона: белый



A3479SP-6CC

↓ 20 ∅ 57
 ♀ 6X40W | E27
 ⚙ 100 ∇ 12



A3479AP-1CC

↓ 23 ↔ 20 ↗ 23
 ♀ 40W | E27





A3459PL-5AB

↑ 27 ∅ 50
 ♀ 5X40W | E27
 ∇ 35



A3459PL-3AB

↑ 27 ∅ 42
 ♀ 3X40W | E27
 ∇ 25



A3459PL-1AB

↑ 25 ∅ 20
 ♀ 40W | E27
 ∇ 12



A3458SP-1AB

↑ 30 ∅ 20
 ♀ 40W | E27
 ∇ 100 ∇ 12



A3459AP-1AB

↑ 23 ↔ 20 ∇ 23
 ♀ 40W | E27



Fixture material: metal painted / metal plated
 Fixture colour: chrome / antique bronze
 Shade material: glass
 Shade colour: white

Материал арматуры: металл крашенный / металл гальванизированный
 Цвет арматуры: хром / античная бронза
 Материал плафона: стекло
 Цвет плафона: белый





A1133SP-6WG

↑ 20 ∅ 63
 ♀ 6X40W | E14
 ⚡ 50 ∇ 12



A1133SP-8WG

↑ 20 ∅ 73
 ♀ 8X40W | E14
 ⚡ 50 ∇ 12



A1133AP-1WG

↑ 38 ↔ 15 ∇ 23
 ♀ 60W | E14



A1133SP-1WG

↑ 33 ∅ 20
 ♀ 60W | E14
 ⚡ 120 ∇ 11



Fixture material: metal painted
 Fixture colour: white gold
 Shade material: glass
 Shade colour: white

Материал арматуры: металл
 крашенный
 Цвет арматуры: бело-золотой
 Материал плафона: стекло
 Цвет плафона: белый



A5349LM-8WH

↑ 40 ∅ 74
 ♀ 8X40W | E14
 ⚡ 50 ∇ 11



A5349LM-5WH

↑ 40 ∅ 62
 ♀ 5X40W | E14
 ⚡ 50 ∇ 11



A5349AP-1WH

↑ 23 ↔ 12 ∇ 22
 ♀ 40W | E14

Fixture material: metal painted, ceramics
 Fixture colour: white

Материал арматуры: металл
 крашенный, керамика
 Цвет арматуры: белый

ANGELINA





A2150SP-5WG

↓ 24 ∅ 68
 ♀ 5X60W | E27
 ⚙ 120 ∇ 12



A2150AP-1WG

↓ 24 ↔ 13 ↗ 20
 ♀ 60W | E27



A2150SP-6WG

↓ 120 ↔ 35 ↗ 100
 ♀ 6X60W | E27
 ∇ 10



A2150SP-1WG

↓ 33 ↔ 30 ↗ 13
 ♀ 60W | E27
 ⚙ 90 ∇ 12

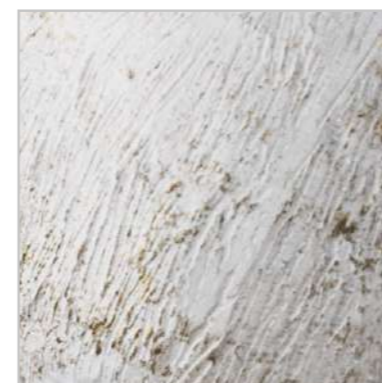

Fixture material: metal painted, poly resin
 Fixture colour: white gold
 Shade material: glass
 Shade colour: white

Материал арматуры: металл крашенный, полимерный материал
 Цвет арматуры: бело-золотой
 Материал плафона: стекло
 Цвет плафона: белый





A4289LM-3WH

↓ 28 ∅ 60
 ♀ 3X40W | E27
 ⚙ 50 ∇ 15



A4289SP-3WH

↓ 36 ↔ 28 ↗ 78
 ♀ 3X40W | E27
 ⚙ 35 ∇ 36X4



A8029SP-1WH

↓ 26 ∅ 20
 ♀ 40W | E27
 ⚙ 100 ∇ 12



A4289SP-1WH

↓ 34 ∅ 34
 ♀ 40W | E27
 ⚙ 100 ∇ 12



A4289AP-1WH

↓ 40 ↔ 18 ↗ 21
 ♀ 40W | E27



A4289LM-6WH

↓ 28 ↔ 28 ↗ 83
 ♀ 6X40W | E27
 ⚙ 30 ∇ 15



Fixture material: metal painted, poly resin
 Fixture colour: white
 Shade material: glass
 Shade colour: clear

Материал арматуры: металл крашенный, полимерный материал
 Цвет арматуры: белый
 Материал плафона: стекло
 Цвет плафона: прозрачный





A3422AP-1GO

↓ 26 ↔ 17 ↗ 34
 ⌀ 60W | E14



Fixture material: metal painted
 Fixture colour: white
 Shade material: glass
 Shade colour: white

Материал арматуры: металл крашенный
 Цвет арматуры: белый
 Материал плафона: стекло
 Цвет плафона: белый



A3422SP-4GO

↓ 30 ↔ 13 ↗ 82
 ⌀ 4X60W | E14
 ⚡ 90 ▽ 25X5



A5695SP-5WH

↓ 40 ⌀ 55
 ⌀ 5X60W | E27
 ⚡ 100 ▽ 12



Fixture material: metal painted
 Fixture colour: white
 Shade material: glass
 Shade colour: white

Материал арматуры: металл крашенный
 Цвет арматуры: белый
 Материал плафона: стекло
 Цвет плафона: белый

PALMER





A5700PN-1WH

↑ 140 ↔ 25 ↗ 65
 ♀ 60W | E27
 ⚡ 200



Fixture material: metal painted, wood
 Fixture colour: white
 Shade material: fabric
 Shade colour: white

Материал арматуры: металл
 крашенный, дерево
 Цвет арматуры: белый
 Материал плафона: ткань
 Цвет плафона: белый



A5700LM-5WH

↑ 56 ∅ 80
 ♀ 5X40W | E14
 ⚡ 60 ∇ 9



A5700LT-1WH

↑ 63 ↔ 20 ↗ 55
 ♀ 60W | E27
 ⚡ 180



A5700AP-1WH

↑ 35 ↔ 17 ↗ 56
 ♀ 40W | E14





Fixture material: metal painted
 Fixture colour: white / gold
 Shade material: acrylic
 Shade colour: clear / white

Материал арматуры: металл крашенный
 Цвет арматуры: белый / золото
 Материал плафона: пластик
 Цвет плафона: прозрачный / белый



A7274PL-27WH

↓ 43 ∅ 73
 ∅ 27X3W | G4
 ∟ 15



A7274SP-36WH

↓ 65 ∅ 75
 ∅ 36X3W | G4
 ∟ 40 ∟ 15



A7274SP-45GO

↓ 65 ∅ 75
 ∅ 45X3W | G4
 ∟ 40 ∟ 15



A7272SP-45GO

↓ 43 ∅ 102
 ∅ 45X3W | G4
 ∟ 55 ∟ 15

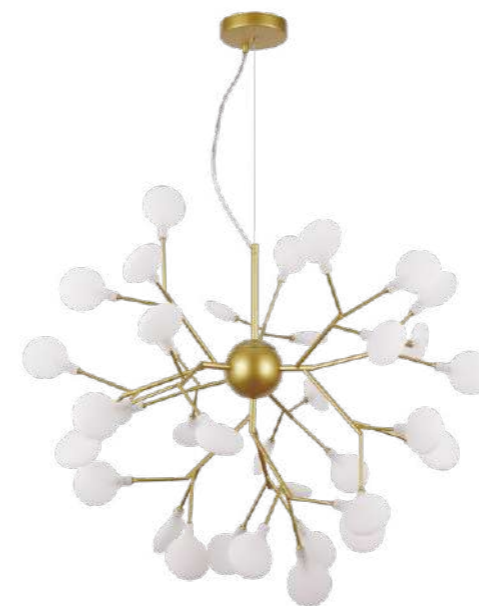

A7274SP-36GO

↓ 65 ∅ 75
 ∅ 36X3W | G4
 ∟ 40 ∟ 15



A7274PL-27GO

↓ 43 ∅ 73
 ∅ 27X3W | G4
 ∟ 15



A7274SP-9GO

↓ 38 ∅ 41
 ∅ 9X3W | G4
 ∟ 60 ∟ 10





A5664AP-1AB

↑ 28 ↔ 17 ↗ 27
 ♀ 60W | E14



A4524PL-3AB

↑ 34 ∅ 60
 ♀ 3X60W | E27
 ∇ 18



A4524SP-1AB

↑ 25 ∅ 18
 ♀ 60W | E27
 ∇ 70 ∇ 12



A4524AP-1AB

↑ 28 ↔ 18 ↗ 20
 ♀ 60W | E27

SAILOR



A5664LM-5AB

↑ 35 ∅ 66
 ♀ 5X60W | E14
 ∇ 60 ∇ 11

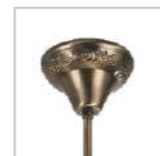

Fixture material: metal plated, wood
 Fixture colour: antique bronze
 Shade material: glass
 Shade colour: clear

Материал арматуры: металл
 гальванизированный, дерево
 Цвет арматуры: античная бронза
 Материал плафона: стекло
 Цвет плафона: прозрачный



Fixture material: metal plated, wood
 Fixture colour: antique bronze
 Shade material: glass
 Shade colour: clear

Материал арматуры: металл
 гальванизированный, дерево
 Цвет арматуры: античная бронза
 Материал плафона: стекло
 Цвет плафона: прозрачный

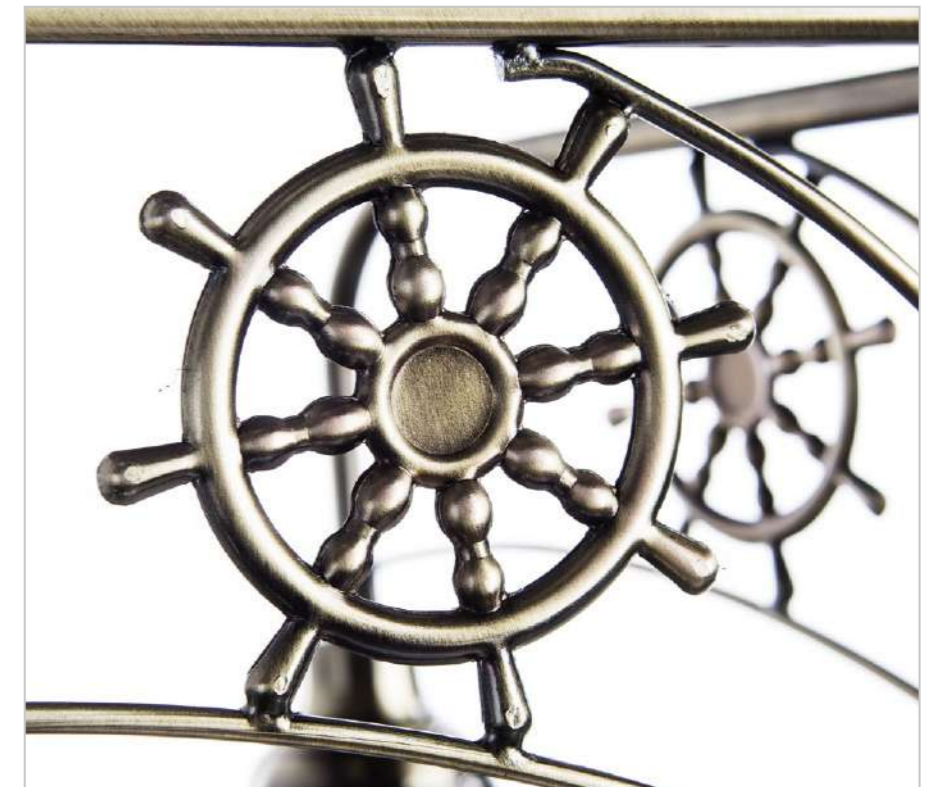

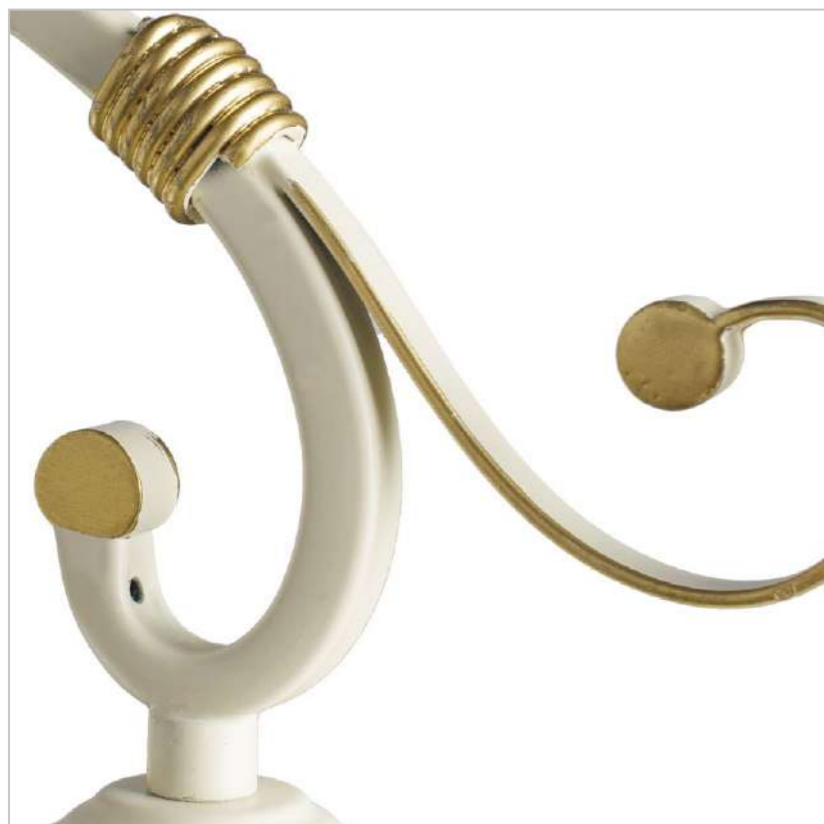

A4577SP-1WG

↑ 30 ∅ 21
 ♀ 60W | E27
 ⚡ 75 ∇ 10



A4577PL-5WG

↑ 35 ∅ 75
 ♀ 5X60W | E27
 ∇ 16



A4577PL-3WG

↑ 35 ∅ 61
 ♀ 3X60W | E27
 ∇ 16



A4577AP-1WG

↑ 32 ↔ 17 ↗ 28
 ♀ 60W | E27



A4577PL-5CK

↑ 35 ∅ 75
 ♀ 5X60W | E27
 ∇ 16



A4577SP-1CK

↑ 30 ∅ 21
 ♀ 60W | E27
 ⚡ 75 ∇ 10



A4577AP-1CK

↑ 32 ↔ 17 ↗ 28
 ♀ 60W | E27



A4577PL-8CK

↑ 37 ∅ 100
 ♀ 8X60W | E27
 ∇ 16



A4577PL-3CK

↑ 35 ∅ 61
 ♀ 3X60W | E27
 ∇ 16



Fixture material: metal painted
 Fixture colour: chocolate / cream
 Shade material: glass
 Shade colour: amber

Материал арматуры: металл крашенный
 Цвет арматуры: шоколад / кремовый
 Материал плафона: стекло
 Цвет плафона: янтарный





Spot Illuminazione

все иллюстрации созданы инструментами нейросети
#Midjourney



A3226AP-1BK

↓ 11 ↔ 6 ↗ 14
 ∅ 35W | GU10



A3226AP-1WH

↓ 11 ↔ 6 ↗ 14
 ∅ 35W | GU10



A3226PL-2BK

↓ 14 ↔ 6 ↗ 22
 ∅ 2X35W | GU10



A3226PL-2WH

↓ 14 ↔ 6 ↗ 22
 ∅ 2X35W | GU10



A3226PL-3BK

↓ 14 ↔ 6 ↗ 35
 ∅ 3X35W | GU10



A3226PL-3WH

↓ 14 ↔ 6 ↗ 35
 ∅ 3X35W | GU10



Fixture material: aluminim
 Fixture colour: black / white
 Shade material: aluminim
 Shade colour: black / white

Материал арматуры: алюминий
 Цвет арматуры: черный / белый
 Материал плафона: алюминий
 Цвет плафона: черный / белый



Matching products /
Другие модели серии
в каталоге



A1906PL-2BK

↑ 16 ↔ 6 ↗ 25
♀ 2X50W | GU10
▽ 10



A1906PL-4BK

↑ 16 ↔ 6 ↗ 60
♀ 4X50W | GU10
▽ 10



A1906AP-1BK

↑ 15 ↔ 6 ↗ 14
♀ 50W | GU10
▽ 10



Fixture material: metal painted
Fixture colour: black / white
Shade material: metal plated, painted
Shade colour: black / white

Материал арматуры: металл крашенный
Цвет арматуры: черный / белый
Материал плафона: металл крашенный, гальванизированный
Цвет плафона: черный / белый



A1906PL-2WH

↑ 16 ↔ 6 ↗ 25
♀ 2X50W | GU10
▽ 10



A1906PL-4WH

↑ 16 ↔ 6 ↗ 60
♀ 4X50W | GU10
▽ 10



A1906AP-1WH

↑ 15 ↔ 6 ↗ 14
♀ 50W | GU10
▽ 10





Matching products /
Другие модели серии
в каталоге



A1311AP-1BK

↑ 8 ↔ 6 ↗ 14
♀ 50W | GU10
▽ 8



A1311PL-2BK

↑ 15 ↔ 6 ↗ 26
♀ 2X50W | GU10
▽ 26X4



A1311PL-4BK

↑ 15 ↔ 6 ↗ 50
♀ 4X50W | GU10
▽ 50X4



A1311PL-4WH

↑ 15 ↔ 6 ↗ 50
♀ 4X50W | GU10
▽ 50X4



A1311PL-2WH

↑ 15 ↔ 6 ↗ 26
♀ 2X50W | GU10
▽ 26X4



A1311AP-1WH

↑ 8 ↔ 6 ↗ 14
♀ 50W | GU10
▽ 8



Fixture material: metal painted
Fixture colour: white / black
Shade material: metal painted
Shade colour: white / black

Материал арматуры: металл крашенный
Цвет арматуры: белый / черный
Материал плафона: металл крашенный
Цвет плафона: белый / черный

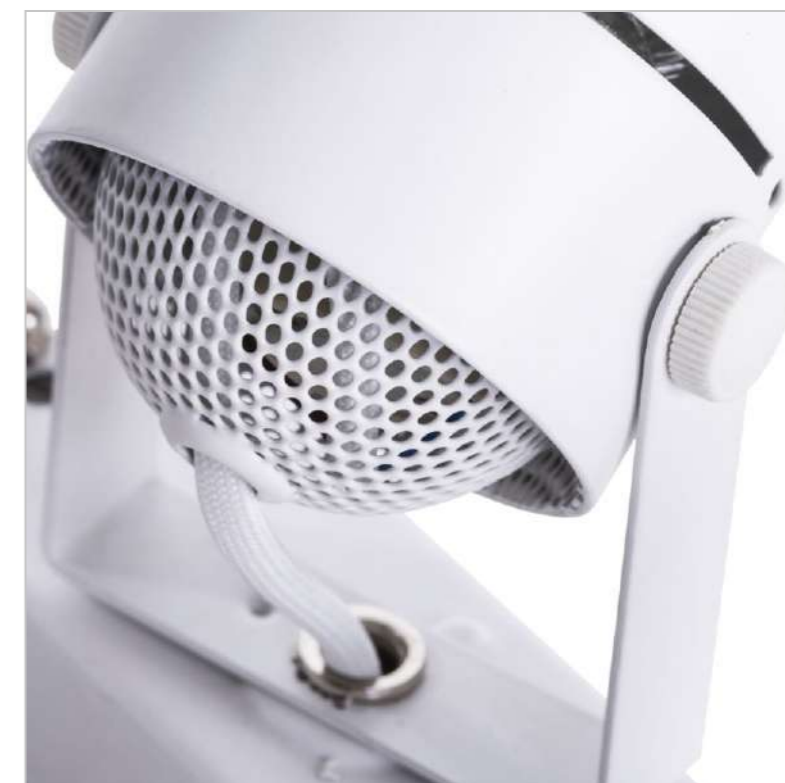



A1315PL-4BK

↑ 15 ↔ 6 ↗ 50
 ♀ 4X50W | GU10
 ∇ 50X4



A1315PL-2BK

↑ 15 ↔ 6 ↗ 26
 ♀ 2X50W | GU10
 ∇ 26X4



A1315AP-1BK

↑ 8 ↔ 6 ↗ 14
 ♀ 50W | GU10
 ∇ 8



Fixture material: metal painted
 Fixture colour: black
 Shade material: metal painted
 Shade colour: black

Материал арматуры: металл крашенный
 Цвет арматуры: черный
 Материал плафона: металл крашенный
 Цвет плафона: черный

Matching products /
 Другие модели серии
 в каталоге



NEW

A2365PL-4WH

↑ 20 ↔ 6 ↗ 80
 ♀ 4X15W | GU10
 ∇ 10



NEW

A2365PL-4BK

↑ 20 ↔ 6 ↗ 80
 ♀ 4X15W | GU10
 ∇ 10



NEW

A2365PL-2BK

↑ 20 ↔ 6 ↗ 32
 ♀ 2X15W | GU10
 ∇ 10



NEW

A2365PL-2WH

↑ 20 ↔ 6 ↗ 32
 ♀ 2X15W | GU10
 ∇ 10



Matching products /
 Другие модели серии
 в каталоге



NEW

A2365AP-1WH

↑ 6 ↔ 6 ↗ 15
 ♀ 15W | GU10
 ∇ 6



NEW

A2365AP-1BK

↑ 6 ↔ 6 ↗ 15
 ♀ 15W | GU10
 ∇ 6



Fixture material: aluminum
 Fixture colour: black / white
 Shade colour: black / white

Материал арматуры: алюминий
 Цвет арматуры: черный / белый
 Цвет плафона: черный / белый

IMAI





Fixture material: metal painted
 Fixture colour: gray / white / gold
 Shade material: metal painted
 Shade colour: gray / white / black

Материал арматуры: металл крашенный
 Цвет арматуры: серый / белый / золото
 Материал плафона: металл крашенный
 Цвет плафона: серый / белый / черный



A1677PL-2GO

↑ 22 ↔ 9 ↗ 28
 ∅ 2X40W | E14
 ∇ 11



A1677PL-2WH

↑ 22 ↔ 9 ↗ 28
 ∅ 2X40W | E14
 ∇ 11



A1677PL-2GY

↑ 22 ↔ 9 ↗ 28
 ∅ 2X40W | E14
 ∇ 11



Matching products /
 Другие модели серии
 в каталоге



A1677AP-1GO

↑ 15 ↔ 9 ↗ 19
 ∅ 40W | E14
 ∇ 11



A1677AP-1WH

↑ 15 ↔ 9 ↗ 19
 ∅ 40W | E14
 ∇ 11



A1677AP-1GY

↑ 15 ↔ 9 ↗ 19
 ∅ 40W | E14
 ∇ 11



A6141AP-2AB

↑ 20 ↔ 18 ↗ 53
 ∅ 2X40W | E14
 ∇ 8



A6141AP-2WH

↑ 20 ↔ 18 ↗ 53
 ∅ 2X40W | E14
 ∇ 8



A6141AP-1AB

↑ 16 ↔ 12 ↗ 20
 ∅ 40W | E14
 ∇ 8



A6141AP-1WH

↑ 16 ↔ 12 ↗ 20
 ∅ 40W | E14
 ∇ 8



Matching products /
 Другие модели серии
 в каталоге

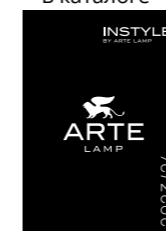

Fixture material: metal plated / metal painted
 Fixture colour: antique bronze / white
 Shade material: metal plated / metal painted
 Shade colour: antique bronze / white

Материал арматуры: металл
 гальванизированный / металл крашенный
 Цвет арматуры: античная бронза / белый
 Материал плафона: металл
 гальванизированный / металл крашенный
 Цвет плафона: античная бронза / белый

SOSPIRO





A1966PL-4GY

↓ 15 ↔ 14 ↗ 70
 ♀ 4X50W | GU10
 ∇ 10



A1966AP-1GY

↓ 17 ↔ 8 ↗ 14
 ♀ 50W | GU10
 ∇ 10



A1966AP-2GY

↓ 17 ↔ 14 ↗ 33
 ♀ 2X50W | GU10
 ∇ 10



Fixture material: metal painted
 Fixture colour: gray
 Shade material: metal painted
 Shade colour: gray

Материал арматуры: металл крашенный
 Цвет арматуры: серый
 Материал плафона: металл крашенный
 Цвет плафона: серый





Bagno

все иллюстрации созданы инструментами нейросети
#Midjourney



A6047PL-1SS

↑ 7,5 ∅ 18
♀ 60W | E27

IP44



A6047PL-2SS

↑ 7,5 ∅ 23
♀ 2X60W | E27

IP44



A6047PL-3SS

↑ 9 ∅ 28
♀ 3X60W | E27

IP44



A6047PL-1BK

↑ 7,5 ∅ 18
♀ 60W | E27

IP44



A6047PL-2BK

↑ 7,5 ∅ 23
♀ 2X60W | E27

IP44



A6047PL-3BK

↑ 9 ∅ 28
♀ 3X60W | E27

IP44



A6047PL-1WH

↑ 7,5 ∅ 18
♀ 60W | E27

IP44



A6047PL-2WH

↑ 7,5 ∅ 23
♀ 2X60W | E27

IP44



A6047PL-3WH

↑ 9 ∅ 28
♀ 3X60W | E27

IP44

Fixture material: metal plated / metal painted
Fixture colour: satin silver / black / white /
antique bronze / chrome
Shade material: glass
Shade colour: white

Материал арматуры: металл
гальванизированный / металл крашенный
Цвет арматуры: матовое серебро / черный /
белый / античная бронза / хром
Материал плафона: стекло
Цвет плафона: белый



A6047PL-1CC

↑7,5 ∅18
 ♀ 60W | E27

IP44



A6047PL-2CC

↑7,5 ∅23
 ♀ 2X60W | E27

IP44



A6047PL-3CC

↑9 ∅28
 ♀ 3X60W | E27

IP44



A6047PL-1AB

↑7,5 ∅18
 ♀ 60W | E27

IP44



A6047PL-2AB

↑7,5 ∅23
 ♀ 2X60W | E27

IP44



A6047PL-3AB

↑9 ∅28
 ♀ 3X60W | E27

IP44

Fixture material: metal plated / metal painted
 Fixture colour: satin silver / black / white /
 antique bronze / chrome
 Shade material: glass
 Shade colour: white

Материал арматуры: металл
 гальванизированный / металл крашенный
 Цвет арматуры: матовое серебро / черный /
 белый / античная бронза / хром
 Материал плафона: стекло
 Цвет плафона: белый





A6812PL-1WH

↑ 6,5 ∅ 19
 ∅ 12W | LED, 1320LM,
 4000K, CRI/RA≥80
 ∇ 16



A6824PL-1WH

↑ 7 ∅ 25
 ∅ 24W | LED, 2640LM,
 4000K, CRI/RA≥80
 ∇ 21



A6818PL-1WH

↑ 6,5 ∅ 22
 ∅ 18W | LED, 1980LM,
 4000K, CRI/RA≥80
 ∇ 18

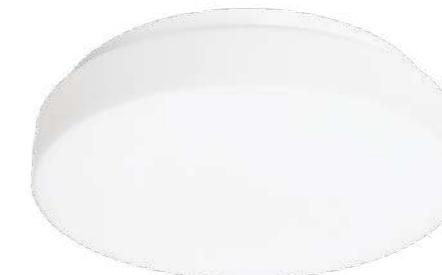

A6836PL-1WH

↑ 7 ∅ 31
 ∅ 36W | LED, 3960LM,
 4000K, CRI/RA≥80
 ∇ 28



Fixture material: metal painted
 Fixture colour: white
 Shade material: glass
 Shade colour: white
 Материал арматуры: металл крашенный
 Цвет арматуры: белый
 Материал плафона: стекло
 Цвет плафона: белый





A5663AP-1CC

↓ 11 ↔ 10 ↗ 14
 ♀ 40W | G9
 ♀ 10

IP44

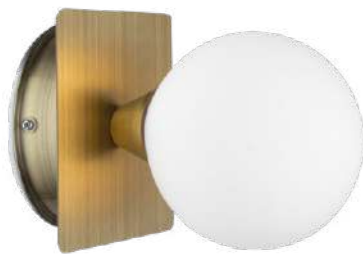

A5663AP-1AB

↓ 11 ↔ 10 ↗ 14
 ♀ 40W | G9
 ♀ 10

IP44

Fixture material: metal plated
 Fixture colour: antique bronze / chrome
 Shade material: glass
 Shade colour: white

Материал арматуры: металл гальванизированный
 Цвет арматуры: античная бронза / хром
 Материал плафона: стекло
 Цвет плафона: белый



NEW
A3410AP-1WH plastic - пластик
 ↓ 8 ↔ 6 ↗ 47
 ♀ 10W | LED, 900LM, 4000K, CRI/RA≥80

incl IP44

power socket included –
 силовая розетка в комплекте



NEW
A4408AP-1CC plastic - пластик
 ↓ 7 ↔ 13 ↗ 40
 ♀ 8W | LED, 720LM, 4000K, CRI/RA≥80

incl IP44



NEW
A4415AP-1CC plastic - пластик
 ↓ 7 ↔ 13 ↗ 60
 ♀ 15W | LED, 1350LM, 4000K, CRI/RA≥80

incl IP44



A2828AP-1AB metal - металл
 ↓ 5 ↔ 10 ↗ 41
 ♀ 12W | LED, 600LM, 3000K, CRI/RA≥80

incl IP44



A2828AP-1CC metal - металл
 ↓ 5 ↔ 10 ↗ 41
 ♀ 12W | LED, 600LM, 3000K, CRI/RA≥80

incl IP44

Fixture material: metal painted, PC / metal plated
 Fixture colour: white / chrome / antique bronze
 Shade material: PC / plastic
 Shade colour: white

Материал арматуры: металл крашенный, пластик / металл гальванизированный
 Цвет арматуры: белый / хром / античная бронза
 Материал плафона: пластик
 Цвет плафона: белый

CALLISTO





A2470AP-2SS

↑5 ↔ 8 ↗45
 ∅ 2X40W | E14



A2470AP-2AB

↑5 ↔ 8 ↗45
 ∅ 2X40W | E14



A2470AP-2BK

↑5 ↔ 8 ↗45
 ∅ 2X40W | E14



A2470AP-2CC

↑5 ↔ 8 ↗45
 ∅ 2X40W | E14



A2470AP-2PB

↑5 ↔ 8 ↗45
 ∅ 2X40W | E14



A1209AP-1CC

↑24 ↔ 8 ↗12
 ∅ 40W | E14



A1209AP-2CC

↑8 ↔ 11 ↗42
 ∅ 2X40W | E14



A1209AP-1AB

↑24 ↔ 8 ↗12
 ∅ 40W | E14



A1209AP-2AB

↑8 ↔ 11 ↗42
 ∅ 2X40W | E14



Fixture material: metal painted / metal plated
 Fixture colour: black / chrome / polished brass / antique bronze / satin silver
 Shade material: glass
 Shade colour: white

Материал арматуры: металл крашенный / металл гальванизированный
 Цвет арматуры: черный / хром / полированная медь / античная бронза / матовое серебро
 Материал плафона: стекло
 Цвет плафона: белый



Fixture material: PC
 Fixture colour: chrome / white
 Shade material: PC
 Shade colour: white

Материал арматуры: пластик
 Цвет арматуры: хром / белый
 Материал плафона: пластик
 Цвет плафона: белый

multi-fastening -
 мультикрепление
 (3 вида)



A2737AP-1WH

↓5 ↔ 11 ↗30
 ∅ 7W | LED, 525LM,
 4000K, CRI/RA≥80
 ∇ 8X1,5



multi-fastening -
 мультикрепление
 (3 вида)



A2737AP-1BK

↓5 ↔ 11 ↗30
 ∅ 7W | LED, 525LM,
 4000K, CRI/RA≥80
 ∇ 8X1,5

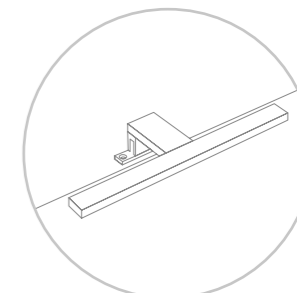

A2737AP-1CC

↓5 ↔ 11 ↗30
 ∅ 7W | LED, 525LM,
 4000K, CRI/RA≥80
 ∇ 8X1,5

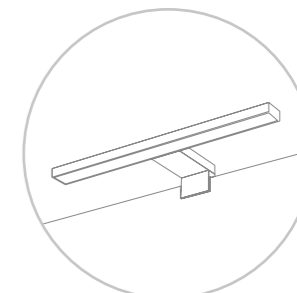

A2737AP-1GO

↓5 ↔ 11 ↗30
 ∅ 7W | LED, 525LM,
 4000K, CRI/RA≥80
 ∇ 8X1,5

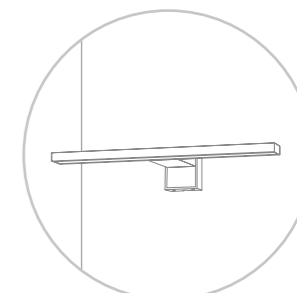

STECCA



Fixture material: PC
 Fixture colour: black / chrome / gold / white
 Shade material: PC
 Shade colour: white

Материал арматуры: пластик
 Цвет арматуры: черный / хром / золото / белый
 Материал плафона: пластик
 Цвет плафона: белый



A2937AP-1WH

↓5 ↔ 11 ↗50
 ∅ 7W | LED, 790LM,
 4000K, CRI/RA≥80
 ∇ 8X1,5



A2937AP-1CC

↓5 ↔ 11 ↗50
 ∅ 7W | LED, 790LM,
 4000K, CRI/RA≥80
 ∇ 8X1,5



A2935AP-1WH

↓5 ↔ 11 ↗30
 ∅ 5W | LED, 520LM,
 4000K, CRI/RA≥80
 ∇ 8X1,5



A2935AP-1CC

↓5 ↔ 11 ↗30
 ∅ 5W | LED, 520LM,
 4000K, CRI/RA≥80
 ∇ 8X1,5





A5210AP-2AB

↓ 32 ↔ 9 ↗ 9
 ∅ 2X40W | E14

IP44



A5210AP-2CC

↓ 32 ↔ 9 ↗ 9
 ∅ 2X40W | E14

IP44



A5210AP-3AB

↓ 45 ↔ 9 ↗ 9
 ∅ 3X40W | E14

IP44



A5210AP-3CC

↓ 45 ↔ 9 ↗ 9
 ∅ 3X40W | E14

IP44



A5210AP-4AB

↓ 55 ↔ 9 ↗ 9
 ∅ 4X40W | E14

IP44



A5210AP-4CC

↓ 55 ↔ 9 ↗ 9
 ∅ 4X40W | E14

IP44

Fixture material: metal plated
 Fixture colour: antique bronze / chrome
 Shade material: glass
 Shade colour: white

Материал арматуры: металл гальванизированный
 Цвет арматуры: античная бронза / хром
 Материал плафона: стекло
 Цвет плафона: белый



Outdoor

все иллюстрации созданы инструментами нейросети
#Midjourney



NEW
A1616LT-1WH

↑ 38 Ø 11
♀ 3W | LED, 250LM, 4000K,
CRI/RA≥80



Fixture material: metal painted
Fixture colour: white / black
Shade material: pc
Shade colour: white



NEW
A1616LT-1BK

↑ 38 Ø 11
♀ 3W | LED, 250LM, 4000K,
CRI/RA≥80



Материал арматуры: металл крашенный
Цвет арматуры: белый / черный
Материал плафона: пластик
Цвет плафона: белый

- Батарея 3000 мА/ч - 3000 mA/h battery
- Время работы - 4-6 часов - Working time - 4-6 hours
- Время зарядки - 2 часа - Charging time - 2 hours
- Сенсорный выключатель - Sensor switch
- USB кабель 150 см в комплекте - 150 cm long USB cable included





Fixture material: metal painted
 Fixture colour: black
 Shade material: metal painted
 Shade colour: black

Материал арматуры: металл крашенный
 Цвет арматуры: черный
 Материал плафона: металл крашенный
 Цвет плафона: черный



A1645PA-1BK

↑ 45 ∅ 9
 ♀ 10W | LED, 350LM,
 4000K, CRI/RA≥80



A1660PA-1BK

↑ 60 ∅ 9
 ♀ 10W | LED, 350LM,
 4000K, CRI/RA≥80



A1680PA-1BK

↑ 80 ∅ 9
 ♀ 10W | LED, 350LM,
 4000K, CRI/RA≥80



A5217AL-1BK

↑ 23 ↔ 10 ↗ 16
 ♀ 20W | E27



A5217FN-1BK

↑ 25 ∅ 10
 ♀ 20W | E27



A5217PA-1BK

↑ 60 ∅ 10
 ♀ 20W | E27



Fixture material: abs
 Fixture colour: black
 Shade material: PC
 Shade colour: clear

Материал арматуры: пластик
 Цвет арматуры: черный
 Материал плафона: пластик
 Цвет плафона: прозрачный



COPPIA



Fixture material: aluminum / stainless steel
 Fixture colour: black / satin silver
 Shade material: PC
 Shade colour: white / clear

Материал арматуры: алюминий / нержавеющая сталь
 Цвет арматуры: черный / матовое серебро
 Материал плафона: пластик / поликарбонат
 Цвет плафона: белый / прозрачный



A3158PA-1SS

↓ 45 ∅ 8
 ∅ 20W | E27

IP44

SALIRE

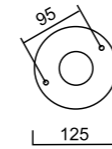

A3157PA-1SS

↓ 110 ∅ 8
 ∅ 20W | E27

IP44

Fixture material: stainless steel
 Fixture colour: satin silver
 Shade material: PC
 Shade colour: white

Материал арматуры: нержавеющая сталь
 Цвет арматуры: матовое серебро
 Материал плафона: поликарбонат
 Цвет плафона: белый



A8381AL-1SS

↓ 23 ↔ 9 ↗ 14
 ∅ 20W | E27

IP44



A8371AL-1BK

↓ 24 ↔ 10 ↗ 15
 ∅ 40W | E27

IP44

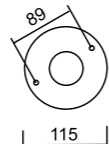

A8381PA-1SS

↓ 50 ∅ 9
 ∅ 20W | E27

IP44

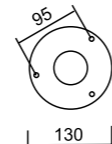

A8371PA-1BK

↓ 65 ∅ 13
 ∅ 40W | E27

IP44





A1631PA-1BK

↓ 45 ↔ 12 ↗ 12
 ∅ 60W | E27

IP54



A1631FN-1BK

↓ 25 ↔ 12 ↗ 12
 ∅ 60W | E27

IP54



A1631AL-1BK

↓ 25 ↔ 12 ↗ 13
 ∅ 60W | E27

IP54

Fixture material: metal painted
 Fixture colour: black
 Shade material: glass
 Shade colour: clear

Материал арматуры: металл крашенный
 Цвет арматуры: черный
 Материал плафона: стекло
 Цвет плафона: прозрачный



A4569PF-2BK

↓ 13 ↔ 29 ↗ 29
 ∅ 2X60W | E27

IP44

Fixture material: metal painted
 Fixture colour: black
 Shade material: glass
 Shade colour: clear

Материал арматуры: металл крашенный
 Цвет арматуры: черный
 Материал плафона: стекло
 Цвет плафона: прозрачный



A4569PA-1BK

↓ 100 ↔ 15 ↗ 15
 ∅ 60W | E27

IP44



A4569SO-1BK

↓ 33 ↔ 15 ↗ 15
 ∅ 60W | E27
 ⌀ 80 ∇ 11

IP44



A4569AL-1BK

↓ 26 ↔ 10 ↗ 15
 ∅ 60W | E27

IP44



A4569AL-2BK

↓ 37 ↔ 10 ↗ 15
 ∅ 2X60W | E27

IP44

BELFAST





Fixture material: metal painted
 Fixture colour: black
 Shade material: PC
 Shade colour: white

Материал арматуры: металл крашенный
 Цвет арматуры: черный
 Материал плафона: пластик
 Цвет плафона: белый



A1991AL-1BK

↑ 20 ↔ 10 ↗ 11
 ♀ 13W | LED, 750LM,
 4000K, CRI/RA≥80



A1991PA-1BK

↑ 60 ↔ 10 ↗ 9
 ♀ 13W | LED, 750LM,
 4000K, CRI/RA≥80



A1992PA-1BK

↑ 100 ↔ 10 ↗ 9
 ♀ 13W | LED, 750LM,
 4000K, CRI/RA≥80



A3710PA-1BK

↑ 100 ↔ 9 ↗ 9
 ♀ 15W | E27



Fixture material: metal painted
 Fixture colour: black
 Shade material: PC
 Shade colour: white

Материал арматуры: металл крашенный
 Цвет арматуры: черный
 Материал плафона: пластик
 Цвет плафона: белый



Power socket incl – силовая розетка

A3711PA-1BK

↑ 42 ↔ 9 ↗ 11
 ♀ 15W | E27



A3710AL-1BK

↑ 24 ↔ 9 ↗ 11
 ♀ 15W | E27



* PIR sensor incl – ИК-детектор



A3711AL-1BK

↑ 24 ↔ 9 ↗ 13
 ♀ 15W | E27



PLATE





NEW

A1910PF-1BK

↓ 10 ∅ 10
∅ 9W | GX53

IP65



A1910AL-1BK

↓ 14 ↔ 10 ↗ 12
∅ 9W | GX53

IP65



A1910AL-2BK

↓ 18 ↔ 10 ↗ 12
∅ 2X9W | GX53

IP65

Fixture material: metal painted
Fixture colour: black
Shade material: PC
Shade colour: clear

Материал арматуры: металл крашенный
Цвет арматуры: черный
Материал плафона: пластик
Цвет плафона: прозрачный



A4421AL-2BK

↓ 29 ↔ 9 ↗ 15
∅ 2X20W | E27

IP44



A4421AL-1BK

↓ 18 ↔ 9 ↗ 15
∅ 20W | E27

IP44



A4421PA-1BK

↓ 60 ↔ 9 ↗ 9
∅ 20W | E27

IP44

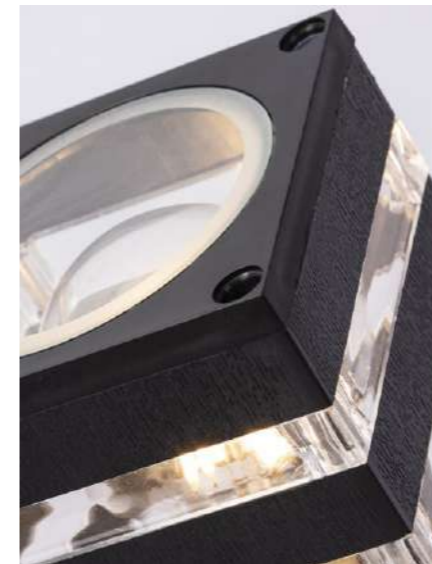

Fixture material: abs
Fixture colour: black
Shade material: PC
Shade colour: clear

Материал арматуры: пластик
Цвет арматуры: черный
Материал плафона: пластик
Цвет плафона: прозрачный

HADAR





Fixture material: metal painted / aluminum, glass
 Fixture colour: black / white
 Shade material: metal painted
 Shade colour: black / white

Материал арматуры: металл крашенный / алюминий, стекло
 Цвет арматуры: черный / белый
 Материал плафона: металл крашенный
 Цвет плафона: черный / белый



A3102AL-1WH

↓ 8 ↔ 7 ↗ 9
 ∅ 35W | GU10

IP44



A3102AL-1BK

↓ 8 ↔ 7 ↗ 9
 ∅ 35W | GU10

IP44



A3102AL-2WH

↓ 15 ↔ 7 ↗ 9
 ∅ 2X35W | GU10

IP44



A3102AL-2BK

↓ 15 ↔ 7 ↗ 9
 ∅ 2X35W | GU10

IP44



A3102FN-1BK

↓ 50 ↔ 7 ↗ 12
 ∅ 35W | GU10

IP65



A3102PA-1BK

↓ 100 ↔ 7 ↗ 12
 ∅ 35W | GU10

IP65



A3503AL-1BK

↓ 12 ↔ 8 ↗ 9
 ∅ 7W | GU10

IP44



A3503AL-1WH

↓ 12 ↔ 8 ↗ 9
 ∅ 7W | GU10

IP44



A3503AL-2BK

↓ 16 ↔ 8 ↗ 9
 ∅ 2X7W | GU10

IP44



A3503AL-2WH

↓ 16 ↔ 8 ↗ 9
 ∅ 2X7W | GU10

IP44



Fixture material: plastic
 Fixture colour: black / white
 Shade material: plastic
 Shade colour: clear

Материал арматуры: пластик
 Цвет арматуры: черный / белый
 Материал плафона: пластик
 Цвет плафона: прозрачный

ATLAS

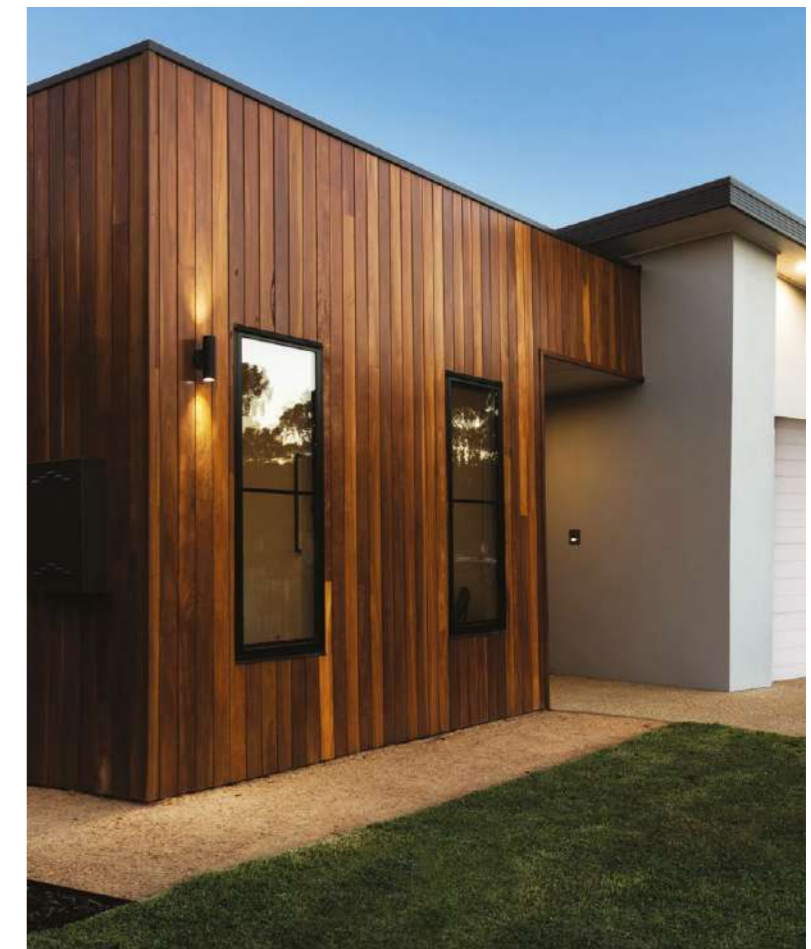



A3304AL-1WH

↓ 15 ↔ 6 ↗ 8
 ∅ 35W | GU10



A3304AL-1BK

↓ 15 ↔ 6 ↗ 8
 ∅ 35W | GU10



A3302AL-2WH

↓ 17 ↔ 6 ↗ 11
 ∅ 2X35W | GU10



A3302AL-2GY

↓ 17 ↔ 6 ↗ 11
 ∅ 2X35W | GU10



A3302AL-2BK

↓ 17 ↔ 6 ↗ 11
 ∅ 2X35W | GU10



A3302PF-1BK

↓ 10 ∅ 6
 ∅ 35W | GU10



A3302PF-1GY

↓ 10 ∅ 6
 ∅ 35W | GU10



A3302PF-1WH

↓ 10 ∅ 6
 ∅ 35W | GU10



A3302PA-1BK

↓ 60 ↔ 6 ↗ 12
 ∅ 35W | GU10



A3302PA-2BK

↓ 60 ↔ 6 ↗ 17
 ∅ 2X35W | GU10



A3302AL-1WH

↓ 13 ↔ 6 ↗ 11
 ∅ 35W | GU10



A3302AL-1GY

↓ 13 ↔ 6 ↗ 11
 ∅ 35W | GU10



A3302AL-1BK

↓ 13 ↔ 6 ↗ 11
 ∅ 35W | GU10



A3303AL-1WH

↓ 15 ↔ 6 ↗ 10
 ∅ 35W | GU10



A3303AL-1GY

↓ 15 ↔ 6 ↗ 10
 ∅ 35W | GU10



A3303AL-1BK

↓ 15 ↔ 6 ↗ 10
 ∅ 35W | GU10



Fixture material: metal painted / aluminum
 Fixture colour: black / gray / white
 Shade material: metal painted / aluminum
 Shade colour: black / gray / white

Материал арматуры: металл крашенный / алюминий
 Цвет арматуры: черный / серый / белый
 Материал плафона: металл крашенный / алюминий
 Цвет плафона: черный / серый / белый

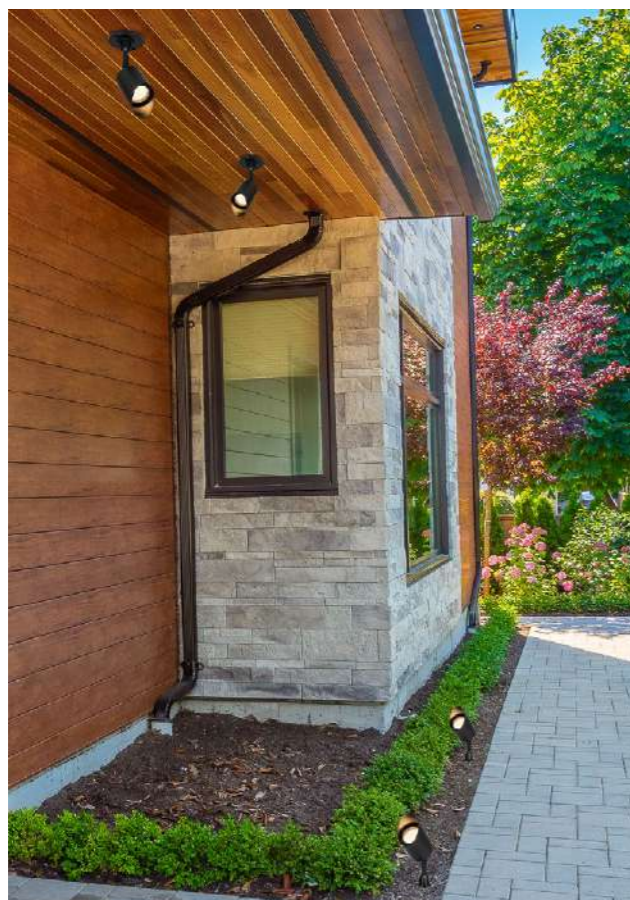

Fixture material: plastic
 Fixture colour: black
 Shade material: plastic
 Shade colour: black

Материал арматуры: пластик
 Цвет арматуры: черный
 Материал плафона: пластик
 Цвет плафона: черный



A1022AL-1BK

↑20 ↔ 6 ↗8
 ♀ 5W | GU10



A1024AL-1BK

↑11 ↔ 5 ↗8
 ♀ 7W | LED, 500LM,
 4000K, CRI/RA≥80



A1022IN-1BK

↑35 ↔ 6 ↗8
 ♀ 5W | GU10



A1831AL-1BK

↑7 ↔ 16 ↗19
 ♀ 7W | LED, 550LM,
 4000K, CRI/RA≥80



A1831PA-1BK

↑70 ↔ 7 ↗16
 ♀ 7W | LED, 550LM,
 4000K, CRI/RA≥80



SAN FRANCISCO

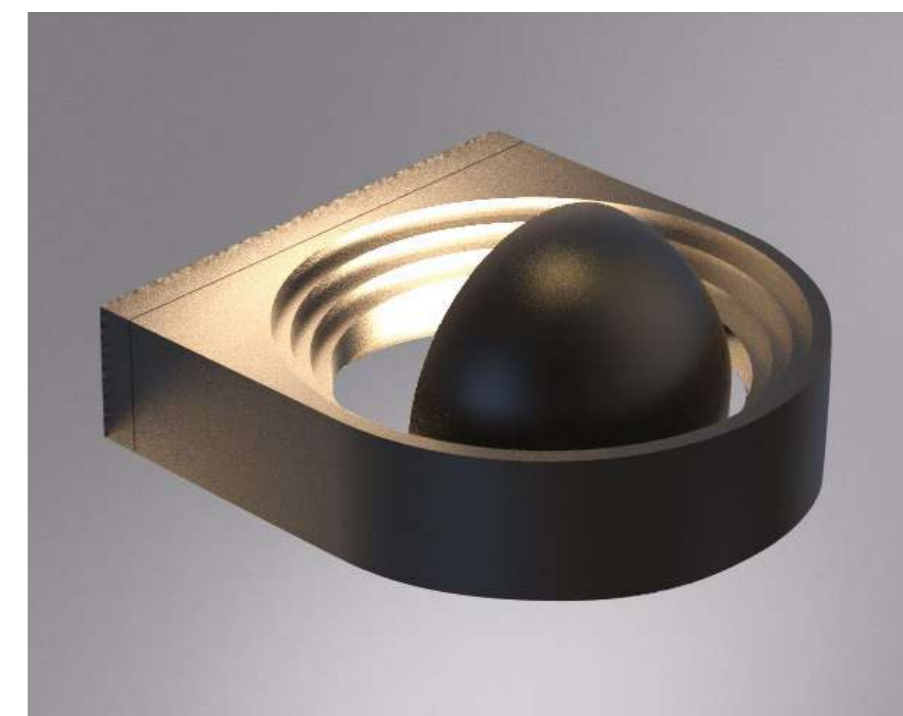

Fixture material: metal painted
 Fixture colour: black
 Shade material: PC
 Shade colour: white

Материал арматуры: металл
 крашенный
 Цвет арматуры: черный
 Материал плафона: пластик
 Цвет плафона: белый



A6218AL-1BK

↑24 ↔ 9 ↗15
 ♀ 40W | E27

IP54

Fixture material: metal painted
 Fixture colour: black
 Shade material: glass
 Shade colour: smoky

Материал арматуры: металл
 крашенный
 Цвет арматуры: черный
 Материал плафона: стекло
 Цвет плафона: дымчатый



A6215PA-1BK

↑50 ∅9
 ♀ 40W | E27

IP54



A6218FN-1BK

↑30 ∅9
 ♀ 40W | E27

IP54



A6218PA-1BK

↑80 ∅9
 ♀ 40W | E27

IP54





Fixture material: stainless steel, aluminum
 Fixture colour: satin silver
 Shade material: glass
 Shade colour: clear

Материал арматуры: нержавеющая сталь, алюминий
 Цвет арматуры: матовое серебро
 Материал плафона: стекло
 Цвет плафона: прозрачный



A2802AL-1GY

↓ 21 ↔ 17 ↗ 13
 ∅ 60W | E27

IP54



A2802AL-1BK

↓ 21 ↔ 17 ↗ 13
 ∅ 60W | E27

IP54



A2801AL-1GY

↓ 13 ↔ 17 ↗ 10
 ∅ 60W | E27

IP54



A2801AL-1BK

↓ 13 ↔ 17 ↗ 10
 ∅ 60W | E27

IP54

Fixture material: aluminum
 Fixture colour: black / gray
 Shade material: glass
 Shade colour: clear

Материал арматуры: алюминий
 Цвет арматуры: черный / серый
 Материал плафона: стекло
 Цвет плафона: прозрачный

URBAN



A6014IN-1SS

↓ 20 ∅ 15
 ∅ 60W | E27

IP67



A6015IN-1SS

↓ 13 ↔ 11 ↗ 11
 ∅ 35W | GU10

IP67



A6017IN-1SS

↓ 13 ∅ 11
 ∅ 35W | GU10

IP67





A1661PA-1BK

↑ 100 ∅ 18
 ♀ 10W | LED, 800LM,
 4000K, CRI/RA≥80



Fixture material: aluminim
 Fixture colour: black
 Shade material: PC
 Shade colour: clear

Материал арматуры: алюминий
 Цвет арматуры: черный
 Материал плафона: пластик
 Цвет плафона: прозрачный



A1661FN-1BK

↑ 34 ∅ 18
 ♀ 10W | LED, 800LM,
 4000K, CRI/RA≥80



A1661AL-1BK

↑ 26 ↔ 16 ↗ 23
 ♀ 10W | LED, 800LM,
 4000K, CRI/RA≥80



A1036AL-1BK

↑ 29 ↔ 13 ↗ 18
 ♀ 40W | E27



Fixture material: metal painted
 Fixture colour: black
 Shade material: glass
 Shade colour: clear

Материал арматуры: металл
 крашенный
 Цвет арматуры: черный
 Материал плафона: стекло
 Цвет плафона: прозрачный

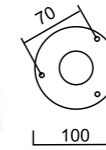

A1036FN-1BK

↑ 34 ∅ 13
 ♀ 40W | E27



A1036PA-1BK

↑ 100 ∅ 13
 ♀ 40W | E27

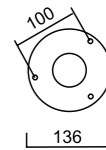



Fixture material: aluminum
 Fixture colour: black
 Shade material: glass
 Shade colour: clear

Материал арматуры: алюминий
 Цвет арматуры: черный
 Материал плафона: стекло
 Цвет плафона: прозрачный

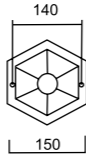

A1016PA-1BK

↑ 110 ∅ 16
 ♀ 60W | E27

IP44

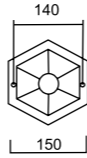

A1014FN-1BK

↑ 30 ∅ 16
 ♀ 60W | E27

IP44



A1011AL-1BK

↑ 36 ↔ 16 ↗ 21
 ♀ 60W | E27

IP44



A1012AL-1BK

↑ 36 ↔ 16 ↗ 21
 ♀ 60W | E27

IP44



A1015SO-1BK

↑ 33 ∅ 16
 ♀ 60W | E27
 ⌀ 50 ∇ 10

IP44



A1492AL-1BK

↑ 45 ↔ 27 ↗ 30
 ♀ 75W | E27

IP44



A1491AL-1BK

↑ 45 ↔ 27 ↗ 30
 ♀ 75W | E27

IP44



A1494FN-1BK

↑ 45 ∅ 27
 ♀ 75W | E27

IP44



A1495SO-1BK

↑ 37 ∅ 27
 ♀ 75W | E27
 ⌀ 65 ∇ 10

IP44



adjustable height bollard -
 регулируемый по высоте
 столб

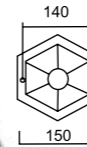

A1497PA-1BK

↑ 210 ∅ 27
 ♀ 75W | E27

IP44

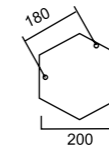

A1496PA-1BK

↑ 120 ∅ 27
 ♀ 75W | E27

IP44

Fixture material: aluminum
 Fixture colour: black
 Shade material: pmma
 Shade colour: white

Материал арматуры: алюминий
 Цвет арматуры: черный
 Материал плафона: пластик
 Цвет плафона: белый

MONACO





A1086PA-2BG

↓ 218 ↔ 28 ↗ 84
 ♀ 2X75W | E27

IP44



A1086PA-3BG

↓ 218 ⌀ 70
 ♀ 3X75W | E27

IP44



A1082AL-1BG

↓ 45 ↔ 28 ↗ 40
 ♀ 75W | E27

IP44



A1085SO-1BG

↓ 26 ⌀ 28
 ♀ 75W | E27
 ⌀ 50 ∇ 10

IP44



A1086PA-1BG

↓ 120 ↔ 28 ↗ 33
 ♀ 75W | E27

IP44

Fixture material: aluminum
 Fixture colour: old brass
 Shade material: PC
 Shade colour: clear

Материал арматуры: алюминий
 Цвет арматуры: старая медь
 Материал плафона: пластик
 Цвет плафона: прозрачный

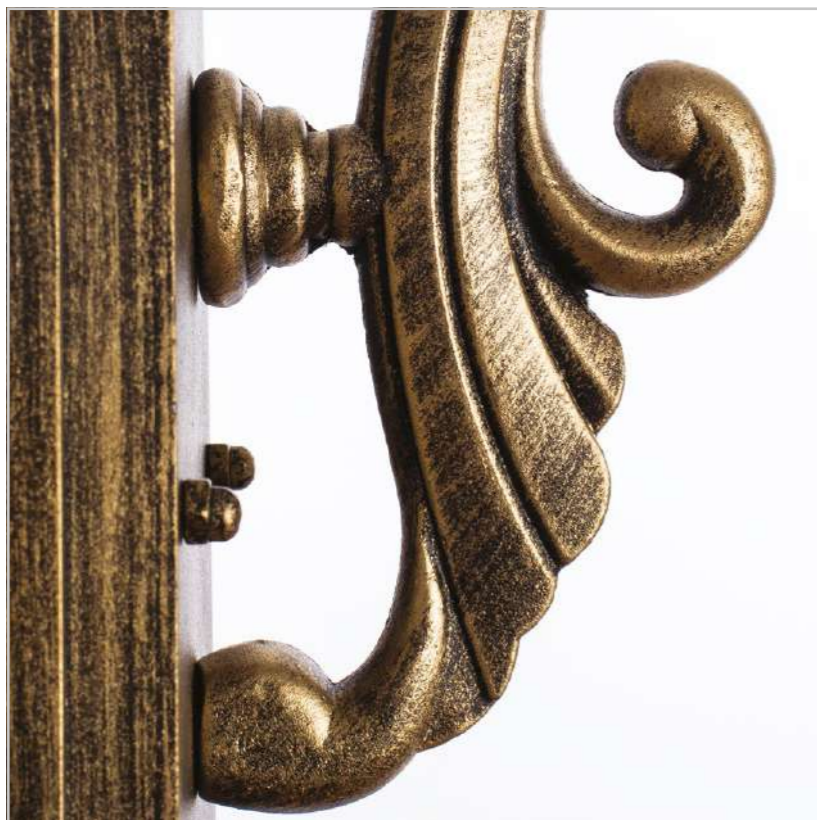

A1317SO-1BN

↑ 31 ∅ 19
 ♀ 75W | E27
 ∩ 50 ∟ 10



A1317AL-1BN

↑ 43 ↔ 19 ∟ 36
 ♀ 75W | E27



Fixture material: aluminum
 Fixture colour: black gold
 Shade material: glass
 Shade colour: white

Материал арматуры: алюминий
 Цвет арматуры: черно-золотой
 Материал плафона: стекло
 Цвет плафона: белый



A1204AL-1BN

↑ 50 ↔ 24 ∟ 26
 ♀ 75W | E27



Fixture material: metal painted
 Fixture colour: black gold
 Shade material: metal painted, glass
 Shade colour: clear

Материал арматуры: металл крашенный
 Цвет арматуры: черно-золотой
 Материал плафона: металл крашенный, стекло
 Цвет плафона: прозрачный



A1204SO-1BN

↑ 47 ∅ 24
 ♀ 75W | E27
 ∩ 10



GENOVA

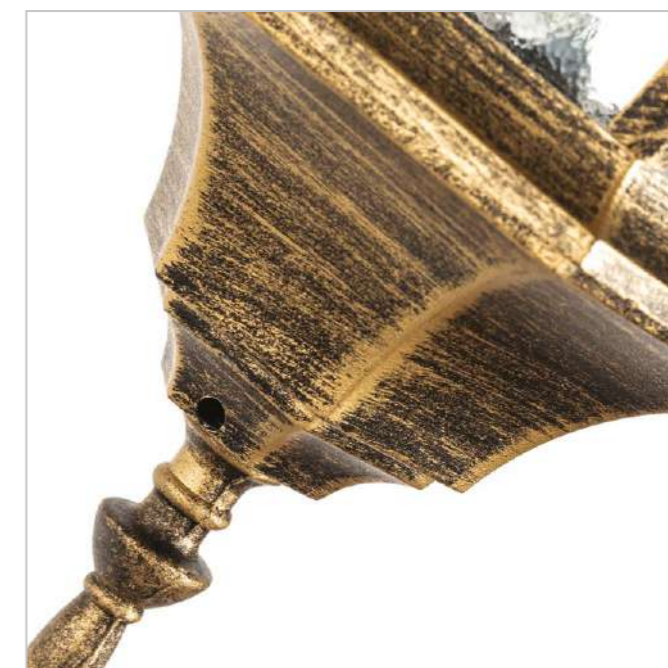



NEW
A1541SO-1BN

↑ 40 ↔ 18 ↗ 18
♀ 75W | E27
♂ 60 ∇ 10



NEW
A1541FN-1BN

↑ 44 ↔ 18 ↗ 18
♀ 75W | E27



NEW
A1541PA-1BN

↑ 100 ↔ 18 ↗ 18
♀ 75W | E27

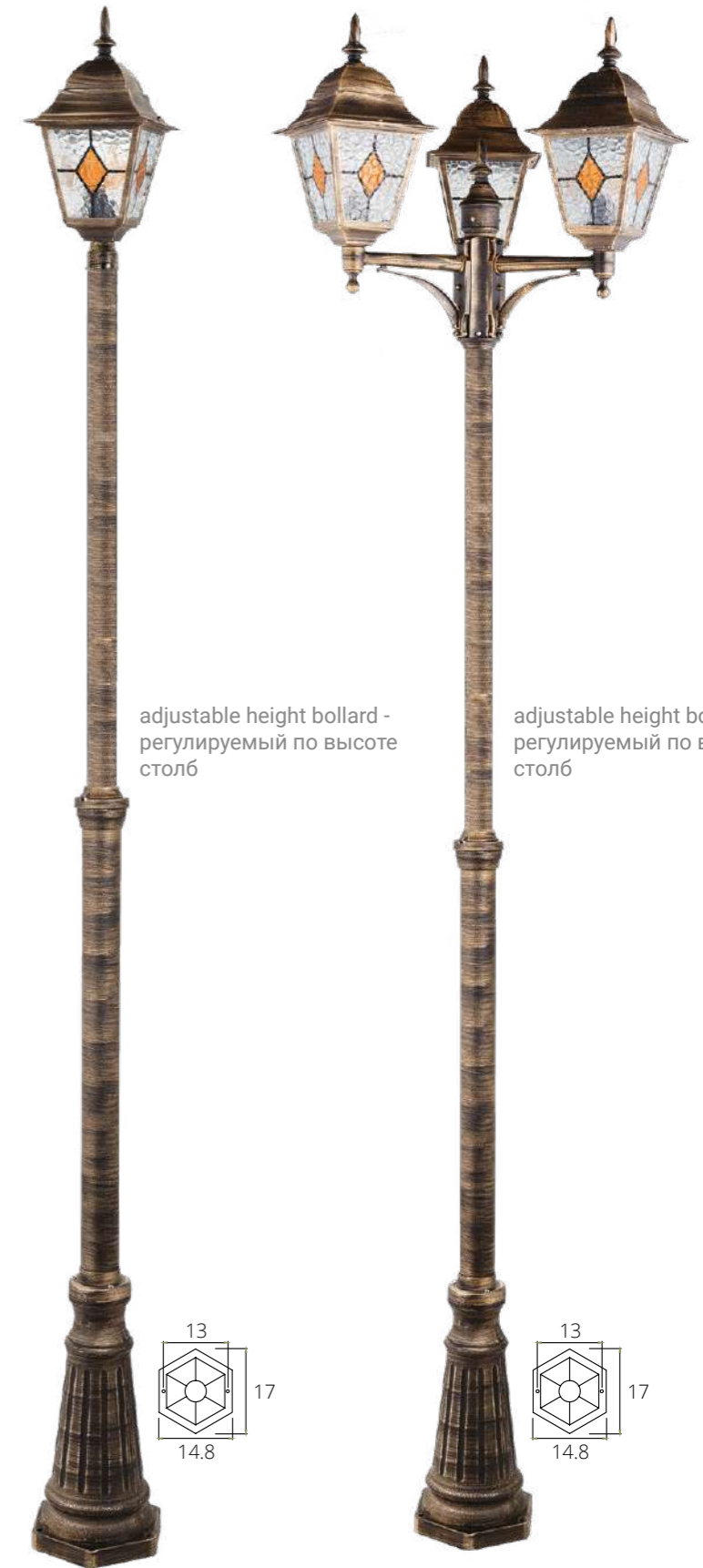

adjustable height bollard -
регулируемый по высоте
столб

adjustable height bollard -
регулируемый по высоте
столб

NEW
A1542PA-1BN

↑ 225 ↔ 18 ↗ 18
♀ 75W | E27



NEW
A1542PA-3BN

↑ 235 ∅ 60
♀ 3X75W | E27



NEW
A1541AL-1BN

↑ 40 ↔ 18 ↗ 21
♀ 75W | E27
∇ 15



NEW
A1542AL-1BN

↑ 40 ↔ 18 ↗ 21
♀ 75W | E27
∇ 15



Fixture material: metal painted
Fixture colour: black gold
Shade material: metal painted, glass
Shade colour: clear
Материал арматуры: металл крашенный
Цвет арматуры: черно-золотой
Материал плафона: металл крашенный, стекло
Цвет плафона: прозрачный

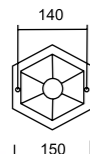

A1044FN-1BN

↑ 50 Ø 16
 ♀ 75W | E27

IP43

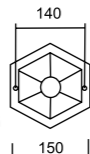

A1046PA-1BN

↑ 118 Ø 16
 ♀ 75W | E27

IP43



A1047PA-1BN

↑ 226 Ø 16
 ♀ 75W | E27

IP43

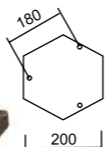

A1047PA-3BN

↑ 230 Ø 55
 ♀ 3X75W | E27

IP43



A1042AL-1BN

↑ 52 ↔ 16 ↗ 22
 ♀ 75W | E27

IP43



A1041AL-1BN

↑ 52 ↔ 16 ↗ 22
 ♀ 75W | E27

IP43



A1045SO-1BN

↑ 38 Ø 16
 ♀ 75W | E27
 ⌀ 50 ∇ 10

IP43

Fixture material: aluminum
 Fixture colour: old brass / black gold
 Shade material: glass
 Shade colour: clear

Материал арматуры: алюминий
 Цвет арматуры: старая медь /
 черно-золотой
 Материал плафона: стекло
 Цвет плафона: прозрачный

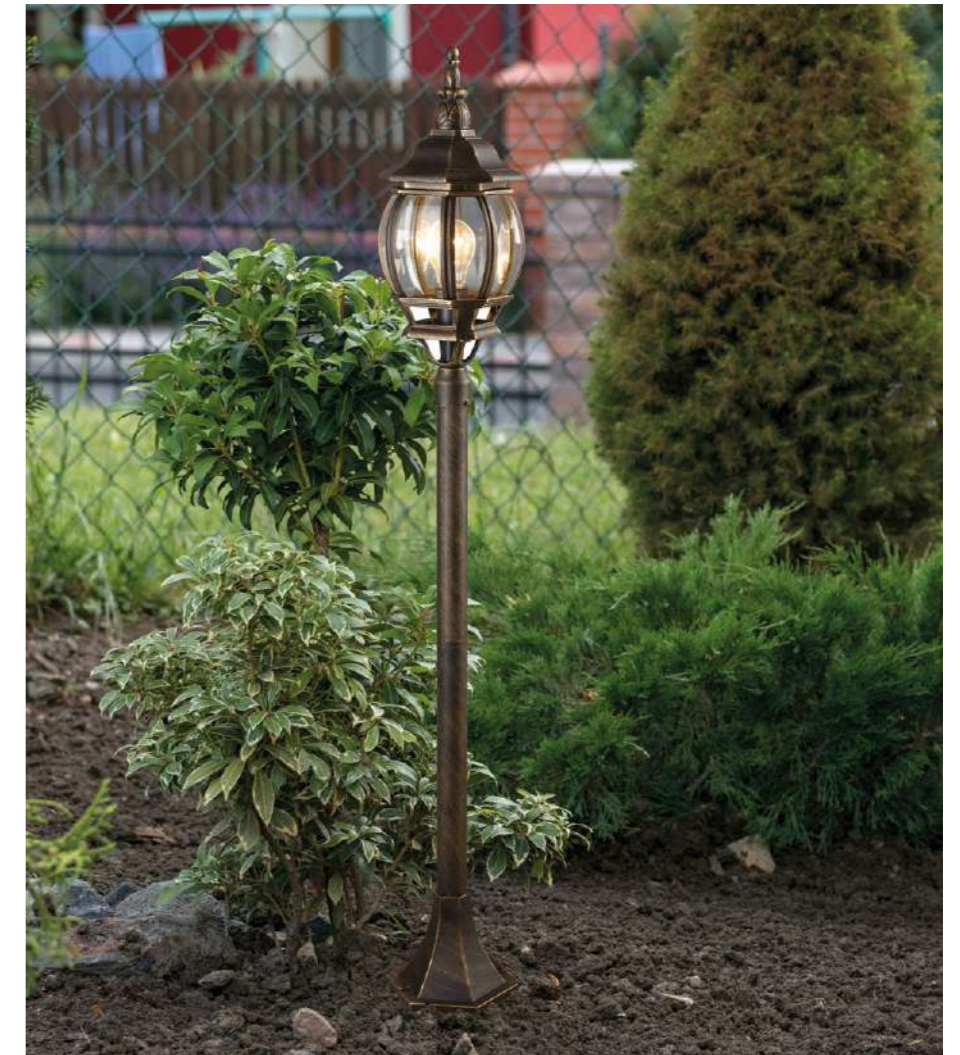



A1041AL-1BG

↑ 52 ↔ 16 ↗ 22
 ∅ 75W | E27

IP43



A1042AL-1BG

↑ 52 ↔ 16 ↗ 22
 ∅ 75W | E27

IP43



A1044FN-1BG

↑ 50 ∅ 16
 ∅ 75W | E27

IP43



A1045SO-1BG

↑ 38 ∅ 16
 ∅ 75W | E27
 ∅ 50 ∅ 10

IP43



A1046PA-1BG

↑ 118 ∅ 16
 ∅ 75W | E27

IP43



A1047PA-3BG

↑ 238 ∅ 50
 ∅ 3X75W | E27

IP43



A1047PA-1BG

↑ 226 ∅ 16
 ∅ 75W | E27

IP43



Fixture material: aluminum
 Fixture colour: old brass / black gold
 Shade material: glass
 Shade colour: clear
 Материал арматуры: алюминий
 Цвет арматуры: старая медь / черно-золотой
 Материал плафона: стекло
 Цвет плафона: прозрачный

PEGASUS



A3152AL-1WG

↑ 36 ↔ 16 ↗ 18
 ♀ 60W | E27

IP44



A3152AL-1BN

↑ 36 ↔ 16 ↗ 18
 ♀ 60W | E27

IP44



A3151AL-1BN

↑ 36 ↔ 16 ↗ 18
 ♀ 60W | E27

IP44



A3151SO-1BN

↑ 30 ∅ 16
 ♀ 60W | E27
 ♂ 50 ∇ 10

IP44



A3151PA-1BN

↑ 108 ∅ 16
 ♀ 60W | E27

IP44



A3151FN-1BN

↑ 40 ∅ 16
 ♀ 60W | E27

IP54

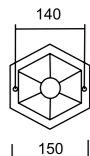
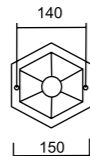

A3100PL-1AC

↑ 13 ∅ 27
 ♀ 60W | E27
 ∇ 27

IP65



A3100PL-1BK

↑ 13 ∅ 27
 ♀ 60W | E27
 ∇ 27

IP65



A3100PL-1WH

↑ 13 ∅ 27
 ♀ 60W | E27
 ∇ 27

IP65



A3121PF-1BN

↑ 12 ∅ 27
 ♀ 60W | E27

IP44



A3121PF-1WG

↑ 12 ∅ 27
 ♀ 60W | E27

IP44

Fixture material: aluminum / metal painted
 Fixture colour: white gold / black gold / antique copper / black / white
 Shade material: glass
 Shade colour: clear / white

Материал арматуры: алюминий / металл крашенный
 Цвет арматуры: бело-золотой / черно-золотой / античная медь / черный / белый
 Материал плафона: стекло
 Цвет плафона: прозрачный / белый



A1002AP-2CC DIADEM	169
A1002LM-6CC DIADEM	169
A1002LM-8CC DIADEM	169
A1003AP-1CC SECUNDA	173
A1003LM-12CC SECUNDA	173
A1003LM-8CC SECUNDA	173
A1004PL-10SI MUSCIDA	167
A1004SP-8SI MUSCIDA	167
A1005AP-2GO MINTAKA	176
A1005PL-10GO MINTAKA	176
A1005PL-8GO MINTAKA	176
A1006AP-2CC WEZEN	171
A1006SP-10CC WEZEN	171
A1006SP-8CC WEZEN	171
A1007AP-2GO ACAPULCO	159
A1007SP-10GO ACAPULCO	159
A1007SP-12GO ACAPULCO	159
A1008AP-2GO ANNABELLE	168
A1008LM-6GO ANNABELLE	168
A1008LM-8GO ANNABELLE	168
A1009AP-2CC ELIZA	166
A1009SP-10CC ELIZA	166
A1009SP-6CC ELIZA	166
A1011AL-1BK BREMEN	464
A1012AL-1BK BREMEN	464
A1014FN-1BK BREMEN	464
A1015SO-1BK BREMEN	464
A1016PA-1BK BREMEN	464
A1021AP-1SS MALLORCA	109
A1021LT-1SS MALLORCA	109
A1021PN-1SS MALLORCA	109
A1021SP-3SS MALLORCA	108
A1021SP-5SS MALLORCA	108
A1022AL-1BK ELSIE	456
A1022IN-1BK ELSIE	456
A1024AL-1BK ELSIE	456
A1025SP-10GO AISHA	164
A1025SP-8GO AISHA	164
A1027SP-10CC ELLIE	165
A1027SP-8CC ELLIE	165
A1028AP-2BK AMBER	153
A1028PL-6BK AMBER	153
A1028PL-8BK AMBER	153
A1034AP-2CC MONTREAL	158
A1034SP-12CC MONTREAL	158
A1034SP-16CC MONTREAL	158
A1036AL-1BK TORONTO	463
A1036FN-1BK TORONTO	463
A1036PA-1BK TORONTO	463
A1037AP-1PB FRANCHESKA	154
A1037SP-6PB FRANCHESKA	154
A1037SP-8PB FRANCHESKA	154
A1039AP-2BK AMELIA	155
A1039SP-10BK AMELIA	155
A1041AL-1BG ATLANTA	474
A1041AL-1BN ATLANTA	473
A1042AL-1BG ATLANTA	474
A1042AL-1BN ATLANTA	473
A1043AP-2BK ALRUBA	152
A1043SP-1BK ALRUBA	152
A1043SP-6BK ALRUBA	152
A1044FN-1BG ATLANTA	474

A1044FN-1BN ATLANTA	472
A1045SO-1BG ATLANTA	474
A1045SO-1BN ATLANTA	473
A1046PA-1BG ATLANTA	475
A1046PA-1BN ATLANTA	472
A1047PA-1BG ATLANTA	475
A1047PA-1BN ATLANTA	472
A1047PA-3BG ATLANTA	475
A1047PA-3BN ATLANTA	472
A1049AP-2GO SANTORINI	156
A1049SP-12GO SANTORINI	156
A1049SP-16GO SANTORINI	156
A1051AP-2CC NICOLETTA	163
A1051SP-10CC NICOLETTA	163
A1051SP-8CC NICOLETTA	163
A1052AP-2GO NICOLETTA	162
A1052SP-10GO NICOLETTA	162
A1052SP-8GO NICOLETTA	162
A1053AP-2PB ALYA	157
A1053SP-10PB ALYA	157
A1053SP-14PB ALYA	157
A1054AP-1CC ELLA	177
A1054AP-1GO ELLA	177
A1054PL-6CC ELLA	177
A1054PL-6GO ELLA	177
A1054PL-9CC ELLA	177
A1054PL-9GO ELLA	177
A1059AP-1CC CARAVAGGIO	380
A1059AP-2CC CARAVAGGIO	381
A1059SP-1CC CARAVAGGIO	380
A1059SP-6CC CARAVAGGIO	381
A1059SP-9CC CARAVAGGIO	381
A1062AP-2CC SARAH	170
A1062SP-6CC SARAH	170
A1063AP-2AB ALBALI	161
A1063AP-2CC ALBALI	161
A1064AP-2CC MATILDA	160
A1064PL-10CC MATILDA	160
A1064PL-12CC MATILDA	160
A1082AL-1BG MALAGA	467
A1085SO-1BG MALAGA	467
A1086PA-1BG MALAGA	467
A1086PA-2BG MALAGA	467
A1086PA-3BG MALAGA	467
A1106LT-1BK CONFERENCE	92
A1106LT-1WH CONFERENCE	92
A1133AP-1WG AMUR	392
A1133SP-1WG AMUR	392
A1133SP-6WG AMUR	392
A1133SP-8WG AMUR	392
A1134SP-7BK OMICRON	332
A1134SP-7PB OMICRON	332
A1204AL-1BN GENOVA	469
A1204SO-1BN GENOVA	469
A1209AP-1AB AQUA-BASTONE	433
A1209AP-1CC AQUA-BASTONE	433
A1209AP-2AB AQUA-BASTONE	433
A1209AP-2CC AQUA-BASTONE	433
A1311AP-1BK MIZAR	414
A1311AP-1WH MIZAR	415
A1311PL-2BK MIZAR	414
A1311PL-2WH MIZAR	415

A1311PL-4BK MIZAR	414
A1311PL-4WH MIZAR	415
A1315AP-1BK MISAM	416
A1315PL-2BK MISAM	416
A1315PL-4BK MISAM	416
A1317AL-1BN VIENNA	468
A1317SO-1BN VIENNA	468
A1330LT-1AB JUNIOR	91
A1330LT-1BK JUNIOR	91
A1330LT-1CC JUNIOR	91
A1330LT-1MG JUNIOR	91
A1330LT-1WH JUNIOR	91
A1363PL-6PB SIENNA	352
A1363PL-8PB SIENNA	352
A1364AP-2PB HOLLY	353
A1364PL-6PB HOLLY	353
A1364PL-8PB HOLLY	353
A1369PL-7SG PEACOCK	228
A1369SP-10SG PEACOCK	229
A1369SP-15SG PEACOCK	229
A1408AP-1AB DORM	124
A1408AP-1BK DORM	124
A1408AP-1WH DORM	124
A1491AL-1BK MONACO	465
A1492AL-1BK MONACO	465
A1494FN-1BK MONACO	465
A1495SO-1BK MONACO	465
A1496PA-1BK MONACO	465
A1497PA-1BK MONACO	465
A1509AP-1PB SEVILLE	113
A1509LT-1PB SEVILLE	113
A1509PN-1PB SEVILLE	113
A1512LT-1BK BOBBY	82
A1512LT-1WH BOBBY	82
A1541AL-1BN MADRID	470
A1541FN-1BN MADRID	471
A1541PA-1BN MADRID	471
A1541SO-1BN MADRID	470
A1542AL-1BN MADRID	470
A1542PA-1BN MADRID	471
A1542PA-3BN MADRID	471
A1550LT-1PB RADISON	48
A1561SP-1CC VOLARE	240
A1561SP-1PB VOLARE	241
A1562SP-1CC VOLARE	240
A1562SP-1PB VOLARE	241
A1563SP-1CC VOLARE	240
A1563SP-1PB VOLARE	241
A1564SP-1CC VOLARE	240
A1564SP-1PB VOLARE	241
A1565SP-1CC VOLARE	240
A1565SP-1PB VOLARE	241
A1577SP-1CC WATERFALL	268
A1577SP-1GO WATERFALL	268
A1581SP-1CC GALACTICA	252
A1582SP-1CC GALACTICA	252
A1583SP-1CC GALACTICA	252
A1616LT-1BK FUYUE	85
A1616LT-1BK FUYUE	441
A1616LT-1WH FUYUE	85
A1616LT-1WH FUYUE	441
A1631AL-1BK POT	446

A1631FN-1BK POT	446
A1631PA-1BK POT	446
A1645PA-1BK NEW YORK	442
A1660PA-1BK NEW YORK	442
A1661AL-1BK HENRY	462
A1661FN-1BK HENRY	462
A1661PA-1BK HENRY	462
A1664AP-1BK BOLLA	234
A1664AP-1CC BOLLA	233
A1664AP-1GO BOLLA	232
A1664SP-12BK BOLLA	235
A1664SP-12CC BOLLA	233
A1664SP-12GO BOLLA	232
A1664SP-15BK BOLLA	235
A1664SP-15CC BOLLA	233
A1664SP-25BK BOLLA	234
A1664SP-25CC BOLLA	233
A1664SP-25GO BOLLA	232
A1670LT-1PB BAYMONT	44
A1677AP-1GO JOVI	418
A1677AP-1GY JOVI	418
A1677AP-1WH JOVI	418
A1677PL-2GO JOVI	418
A1677PL-2GY JOVI	418
A1677PL-2WH JOVI	418
A1680PA-1BK NEW YORK	442
A1709AP-1AB HARRISON	143
A1709AP-1BK HARRISON	143
A1709AP-1CC HARRISON	143
A1709AP-1GO HARRISON	143
A1711AP-1AB HARRISON	143
A1711AP-1BK HARRISON	143
A1711AP-1CC HARRISON	143
A1711AP-1GO HARRISON	143
A1722AP-1BA STEFAN	279
A1722SP-6BA STEFAN	279
A1831AL-1BK SAN FRANCISCO	457
A1831PA-1BK SAN FRANCISCO	457
A1847SP-36BK CINTA	291
A1847SP-46BK CINTA	291
A1868AP-1PB GRACE	302
A1868SP-1PB GRACE	302
A1868SP-2PB GRACE	302
A1868SP-3PB GRACE	302
A1874SP-32BK RICCO	294
A1874SP-45BK RICCO	294
A1900SP-8AB VOLARE	238
A1902SP-1BK ARWEN	263
A1902SP-1WH ARWEN	263
A1903SP-1BK ARWEN	263
A1903SP-1WH ARWEN	263
A1906AP-1BK ALMACH	412
A1906AP-1WH ALMACH	413
A1906PL-2BK ALMACH	412
A1906PL-2WH ALMACH	413
A1906PL-4BK ALMACH	412
A1906PL-4WH ALMACH	413
A1910AL-1BK NUNKI	450
A1910AL-2BK NUNKI	450
A1910PF-1BK NUNKI	450
A1915SP-1AB VOLARE	237
A1915SP-1CC VOLARE	236

A1915SP-1GO | VOLARE 239
A1915SP-3AB | VOLARE 238
A1916SP-1BK | HANNAH 330
A1916SP-1CC | HANNAH 330
A1916SP-1GO | HANNAH 330
A1920SP-1AB | VOLARE 237
A1920SP-1CC | VOLARE 236
A1920SP-1GO | VOLARE 239
A1921AP-1AB | BOLLA-UNICA 245
A1921AP-1CC | BOLLA-UNICA 242
A1921LT-1AB | BOLLA-UNICA 244
A1921LT-1CC | BOLLA-UNICA 242
A1921PN-1AB | BOLLA-UNICA 244
A1921PN-1CC | BOLLA-UNICA 242
A1921SP-1AB | BOLLA-UNICA 245
A1921SP-1CC | BOLLA-UNICA 243
A1922SP-1AB | BOLLA-UNICA 245
A1922SP-1CC | BOLLA-UNICA 243
A1923SP-1AB | BOLLA-UNICA 245
A1923SP-1CC | BOLLA-UNICA 243
A1924AP-1AB | BOLLA-UNICA 245
A1924AP-1CC | BOLLA-UNICA 242
A1924SP-1AB | BOLLA-UNICA 245
A1924SP-1CC | BOLLA-UNICA 243
A1925SP-1AB | VOLARE 237
A1925SP-1CC | VOLARE 236
A1925SP-1GO | VOLARE 239
A1930SP-1AB | VOLARE 237
A1930SP-1CC | VOLARE 236
A1940SP-1AB | VOLARE 237
A1940SP-1CC | VOLARE 236
A1966AP-1GY | REGISTA 421
A1966AP-2GY | REGISTA 421
A1966PL-4GY | REGISTA 421
A1991AL-1BK | METROPOLIS 448
A1991PA-1BK | METROPOLIS 448
A1992PA-1BK | METROPOLIS 448
A1992SP-1PB | BELL 260
A2020LT-1PB | RADISON 48
A2025AP-1BK | PHOENIX 132
A2025AP-1PB | PHOENIX 132
A2026AP-1BK | SARGAS 132
A2027AP-1BK | POLIS 133
A2027AP-1CC | POLIS 133
A2027AP-1GO | POLIS 133
A2027AP-1PB | POLIS 133
A2028AP-1BK | PRIMA 135
A2028AP-1CC | PRIMA 135
A2028AP-1GO | PRIMA 135
A2028AP-1PB | PRIMA 135
A2029AP-1BK | LINES 134
A2029AP-1CC | LINES 134
A2029AP-1GO | LINES 134
A2029AP-1PB | LINES 134
A2033AP-1BK | TRAPEZE 344
A2033AP-1PB | TRAPEZE 344
A2033AP-1WH | TRAPEZE 344
A2034SP-1BK | ASCELLA 333
A2034SP-1WH | ASCELLA 333
A2039AP-10BK | MISSILE 130
A2039AP-13BK | MISSILE 130
A2054AP-1AB | BRACCIO 97

A2054AP-1BK | BRACCIO 97
A2054AP-1WH | BRACCIO 97
A2054LT-1AB | BRACCIO 96
A2054LT-1BK | BRACCIO 96
A2054LT-1WH | BRACCIO 96
A2054PN-1AB | BRACCIO 98
A2054PN-1BK | BRACCIO 98
A2054PN-1WH | BRACCIO 98
A2054SP-1AB | BRACCIO 98
A2054SP-1BK | BRACCIO 98
A2054SP-1WH | BRACCIO 98
A2055AP-1AB | BRACCIO 97
A2055AP-1BK | BRACCIO 97
A2055AP-1WH | BRACCIO 97
A2055SP-1AB | BRACCIO 99
A2055SP-1BK | BRACCIO 99
A2055SP-1WH | BRACCIO 99
A2070PN-1BK | COMBO 120
A2090SP-1BK | BEEMIM 357
A2090SP-1PB | BEEMIM 357
A2102LT-1WH | CONNOR 121
A2102PN-1WH | CONNOR 121
A2124SP-1BK | FURUD 325
A2125AP-1BK | FURUD 325
A2133AP-1GO | SNOWDROP 343
A2135AP-1PB | MICHAEL 342
A2136AP-1PB | MICHAEL 342
A2142AP-10BK | MIRACH 131
A2142AP-10PB | MIRACH 131
A2150AP-1WG | GEMELLI 394
A2150SP-1WG | GEMELLI 395
A2150SP-5WG | GEMELLI 394
A2150SP-6WG | GEMELLI 395
A2170PL-49BK | ZULU 322
A2172AP-2BK | JOSEPH 347
A2173AP-1BK | ALBERT 345
A2173AP-1PB | ALBERT 345
A2174SP-5BK | POPLAR 319
A2180SP-60BK | ALFIE 288
A2180SP-60WH | ALFIE 288
A2182SP-160CC | ORIONE 297
A2182SP-160PB | ORIONE 297
A2183SP-1BK | MERCURY 293
A2185SP-3BK | MERCURY 293
A2186SP-1BK | RING 299
A2186SP-1WH | RING 299
A2187AP-1GO | DARCY 300
A2187LM-1GO | DARCY 301
A2187LM-3GO | DARCY 301
A2187SP-1GO | DARCY 300
A2187SP-2GO | DARCY 300
A2189LM-1BK | LAO 298
A2189SP-1BK | LAO 298
A2190SP-1BK | LAO 298
A2191SP-18BK | FRANKIE 331
A2191SP-18PB | FRANKIE 331
A2191SP-6BK | FRANKIE 331
A2191SP-6PB | FRANKIE 331
A2193SP-36BK | FANTASY 327
A2194SP-2BK | MADISON 290
A2194SP-2PB | MADISON 290
A2195AP-1BK | ERRAI 322

A2195SP-5BK | ERRAI 322
A2196SP-2CC | HARLEY 287
A2196SP-3CC | HARLEY 287
A2197SP-2BK | FRODO 283
A2197SP-2WH | FRODO 282
A2197SP-3BK | FRODO 283
A2197SP-3WH | FRODO 282
A2198SP-2BK | MERIDIANA 285
A2198SP-2CC | MERIDIANA 286
A2198SP-2GO | MERIDIANA 284
A2198SP-2WH | MERIDIANA 284
A2198SP-3BK | MERIDIANA 285
A2198SP-3CC | MERIDIANA 286
A2198SP-3GO | MERIDIANA 284
A2198SP-3WH | MERIDIANA 284
A2199PL-5BK | FERNANDO 323
A2199PL-6BK | FERNANDO 323
A2211PL-2BK | SIERRA 354
A2211PL-2WH | SIERRA 354
A2211SP-2BK | VERITATE 289
A2211SP-2WH | VERITATE 289
A2213AP-2BK | SYRMA 356
A2213AP-2WH | SYRMA 356
A2216AP-1BK | ALUDRA 136
A2216AP-1WH | ALUDRA 136
A2217AP-2BK | ACRUX 137
A2217AP-2WH | ACRUX 137
A2219PL-2BK | RASALAS 326
A2220PL-3BK | PISCES 348
A2220PL-3GO | PISCES 348
A2220PL-3WH | PISCES 348
A2221SP-1BR | VERITATE 295
A2222SP-1BK | SHINE 292
A2222SP-3BK | SHINE 292
A2223SP-1BK | SMOOTH 290
A2223SP-1PB | SMOOTH 290
A2224AP-1BK | ALCOR 230
A2224PL-1BK | ALCOR 231
A2224PL-1PB | ALCOR 231
A2224PL-6BK | ALCOR 230
A2224PL-8BK | ALCOR 230
A2224PN-2BK | ALCOR 231
A2224SP-3BK | ALCOR 231
A2224SP-6BK | ALCOR 231
A2224SP-8BK | ALCOR 231
A2230LT-1PB | RIZZI 68
A2231PL-5PB | FREDDIE 264
A2231SP-1PB | FREDDIE 265
A2231SP-9PB | FREDDIE 264
A2232SP-1PB | FREDDIE 265
A2233AP-20BK | LUMINO 315
A2233AP-20GO | LUMINO 315
A2233SP-20BK | LUMINO 315
A2233SP-20GO | LUMINO 315
A2234SP-1PB | FREDDIE 265
A2243LT-4PB | GEMINI 257
A2243PL-3PB | GEMINI 257
A2243PN-6PB | GEMINI 257
A2243SP-9PB | GEMINI 257
A2283AP-1GO | GRAPPOLO 303
A2283SP-14GO | GRAPPOLO 303
A2306SP-6GO | IDILLIO 334

A2307SP-1WH | KRAZ 211
A2308SP-1BK | SABIK 211
A2341SP-2BK | GENEVA 318
A2341SP-4BK | GENEVA 318
A2341SP-6BK | GENEVA 318
A2365AP-1BK | IMAI 417
A2365AP-1WH | IMAI 417
A2365PL-2BK | IMAI 417
A2365PL-2WH | IMAI 417
A2365PL-4BK | IMAI 417
A2365PL-4WH | IMAI 417
A2404LT-1AM | PADOVA 335
A2404LT-1SM | PADOVA 335
A2404SP-23AM | PADOVA 335
A2404SP-23SM | PADOVA 335
A2404SP-33AM | PADOVA 335
A2404SP-33SM | PADOVA 335
A2423AP-5CC | SULAFAT 129
A2423AP-5PB | SULAFAT 129
A2426PL-3BK | SIERRA 355
A2426PL-3GO | SIERRA 355
A2470AP-2AB | AQUA-BASTONE 432
A2470AP-2BK | AQUA-BASTONE 432
A2470AP-2CC | AQUA-BASTONE 432
A2470AP-2PB | AQUA-BASTONE 432
A2470AP-2SS | AQUA-BASTONE 432
A2471LM-16BK | MARKAB 307
A2471LM-20BK | MARKAB 307
A2471SP-12BK | MARKAB 307
A2482SP-20BK | EMPIRE 313
A2482SP-32BK | EMPIRE 313
A2482SP-84BK | EMPIRE 312
A2487PN-1BK | GOLIATH 118
A2487PN-1WH | GOLIATH 118
A2489AP-1GO | OVALE 304
A2489PL-5GO | OVALE 304
A2489PL-8GO | OVALE 304
A2489SP-1GO | OVALE 304
A2490AP-1BK | POSTERIOR 128
A2490AP-1PB | POSTERIOR 128
A2492LT-1AB | BANKER 86
A2493LT-1AB | BANKER 86
A2505SP-2BK | LARGO 321
A2505SP-2WH | LARGO 321
A2522SP-2BK | SWING 296
A2522SP-2WH | SWING 296
A2563AP-1PB | ALMAAZ 337
A2564AP-1PB | ALMAAZ 337
A2565SP-1BK | DOLORES 328
A2565SP-1PB | DOLORES 328
A2581AP-1AB | ELBA 103
A2581AP-1CC | ELBA 102
A2581AP-2AB | ELBA 103
A2581AP-2CC | ELBA 102
A2581LT-1AB | ELBA 103
A2581LT-1CC | ELBA 102
A2581PN-1AB | ELBA 103
A2581PN-1CC | ELBA 102
A2581PN-2AB | ELBA 103
A2581PN-2CC | ELBA 102
A2589AP-1SS | RODOS 107
A2589LT-1SS | RODOS 107

A2589PN-1SS RODOS	107
A2600PL-32BK LUCAS	349
A2600PL-32GO LUCAS	349
A2602AP-10BK LUCAS	349
A2602AP-10WH LUCAS	349
A2604AP-7BK POLARIS	324
A2604AP-7GO POLARIS	324
A2605AP-7BK MARS	340
A2607AP-20BK TOMMY	351
A2607AP-20GO TOMMY	351
A2607PL-22BK TOMMY	350
A2607PL-22GO TOMMY	350
A2607PL-30BK TOMMY	351
A2607PL-30GO TOMMY	351
A2608AP-2BK ZOSMA	346
A2608PL-5BK ZOSMA	347
A2608PL-7BK ZOSMA	347
A2610SP-85BK POLARIS	324
A2611PL-3BK NIHAL	346
A2611PL-4BK NIHAL	346
A2613AP-2BK TOLIMAN	352
A2613SP-4BK TOLIMAN	352
A2640AP-1GO BISCOTTO	341
A2641AP-1GO BISCOTTO	341
A2642AP-1GO BISCOTTO	341
A2643AP-1GO BISCOTTO	341
A2644AP-1GO BISCOTTO	341
A2719AP-2CC VIVIEN	174
A2719AP-2GO VIVIEN	175
A2719SP-6CC VIVIEN	174
A2719SP-6GO VIVIEN	175
A2719SP-8CC VIVIEN	174
A2719SP-8GO VIVIEN	175
A2737AP-1BK STECCA	435
A2737AP-1CC STECCA	435
A2737AP-1GO STECCA	435
A2737AP-1WH STECCA	435
A2780LM-30PB CROCUS	306
A2780LM-40PB CROCUS	306
A2801AL-1BK URBAN	461
A2801AL-1GY URBAN	461
A2802AL-1BK URBAN	461
A2802AL-1GY URBAN	461
A2808SP-1BK LAYLA	317
A2828AP-1AB CALLISTO	431
A2828AP-1CC CALLISTO	431
A2848AP-2GO JASTIN	378
A2848LM-8GO JASTIN	379
A2848PL-5GO JASTIN	379
A2848SP-3GO JASTIN	379
A2848SP-5GO JASTIN	379
A2848SP-8GO JASTIN	378
A2850AP-13BK KLIMT	310
A2850AP-13PB KLIMT	309
A2850LM-75PB KLIMT	309
A2850PL-32BK KLIMT	310
A2850PL-32BK KLIMT	310
A2850PL-32PB KLIMT	309
A2850PL-32PB KLIMT	309
A2850PN-35BK KLIMT	310
A2850PN-35PB KLIMT	309
A2850SP-45BK KLIMT	311

A2850SP-45PB KLIMT	308
A2850SP-75BK KLIMT	311
A2850SP-75PB KLIMT	309
A2850SP-80BK KLIMT	310
A2850SP-80PB KLIMT	308
A2917SP-33BK DUBHE	320
A2918PN-1BK MACLEAN	316
A2918SP-1BK MACLEAN	316
A2935AP-1CC ORIZZONE	434
A2935AP-1WH ORIZZONE	434
A2937AP-1CC ORIZZONE	434
A2937AP-1WH ORIZZONE	434
A2995LM-8CC OMBRA	386
A3100PL-1AC PEGASUS	477
A3100PL-1BK PEGASUS	477
A3100PL-1WH PEGASUS	477
A3102AL-1BK COMPASS	452
A3102AL-1WH COMPASS	452
A3102AL-2BK COMPASS	452
A3102AL-2WH COMPASS	452
A3102FN-1BK COMPASS	452
A3102PA-1BK COMPASS	452
A3116AP-1AB FALENA	126
A3116AP-1BK FALENA	126
A3116AP-1SS FALENA	126
A3116AP-1WH FALENA	126
A3117AP-1BK FALENA	127
A3117AP-1WH FALENA	127
A3117PL-2BK FALENA	127
A3117PL-2WH FALENA	127
A3117PL-4BK FALENA	127
A3117PL-4WH FALENA	127
A3121PF-1BN PEGASUS	477
A3121PF-1WG PEGASUS	477
A3143AP-2BK RAN	207
A3143AP-2PB RAN	208
A3144SP-1BK RAN	207
A3144SP-1PB RAN	208
A3145SP-1BK RAN	207
A3145SP-1PB RAN	208
A3147SP-1BK RAN	207
A3147SP-1PB RAN	208
A3151AL-1BN PEGASUS	476
A3151FN-1BN PEGASUS	476
A3151PA-1BN PEGASUS	476
A3151SO-1BN PEGASUS	476
A3152AL-1BN PEGASUS	476
A3152AL-1WG PEGASUS	476
A3157PA-1SS SALIRE	445
A3158PA-1SS SALIRE	445
A3162SP-1BK RAN	207
A3162SP-1PB RAN	208
A3220SP-1PB HOLLY	329
A3225SP-1PB HOLLY	329
A3226AP-1BK AQUARIUS	411
A3226AP-1WH AQUARIUS	411
A3226PL-2BK AQUARIUS	411
A3226PL-2WH AQUARIUS	411
A3226PL-3BK AQUARIUS	411
A3226PL-3WH AQUARIUS	411
A3230SP-1PB HOLLY	329
A3280SP-1BK SADR	209

A3280SP-1WH SADR	209
A3302AL-1BK MISTERO	455
A3302AL-1GY MISTERO	455
A3302AL-1WH MISTERO	455
A3302AL-2BK MISTERO	455
A3302AL-2GY MISTERO	455
A3302AL-2WH MISTERO	455
A3302PA-1BK MISTERO	454
A3302PA-2BK MISTERO	454
A3302PF-1BK MISTERO	454
A3302PF-1GY MISTERO	454
A3302PF-1WH MISTERO	454
A3303AL-1BK MISTERO	455
A3303AL-1GY MISTERO	455
A3303AL-1WH MISTERO	455
A3304AL-1BK MISTERO	454
A3304AL-1WH MISTERO	454
A3315SP-1PB BOLLA-SOLA	249
A3320SP-1PB BOLLA-SOLA	249
A3325SP-1PB BOLLA-SOLA	249
A3330SP-1PB BOLLA-SOLA	249
A3406SP-1BK CAPPELLO	212
A3407SP-1BK CAPPELLO	212
A3408SP-1BK CAPPELLO	212
A3410AP-1WH CALLISTO	431
A3422AP-1GO ELTANIN	398
A3422SP-4GO ELTANIN	398
A3458SP-1AB SERENATA	391
A3459AP-1AB SERENATA	391
A3459PL-1AB SERENATA	390
A3459PL-3AB SERENATA	390
A3459PL-5AB SERENATA	390
A3463LT-1WH HADAR	54
A3479AP-1CC SERENATA	388
A3479PL-1CC SERENATA	389
A3479PL-3CC SERENATA	389
A3479PL-5CC SERENATA	389
A3479PL-9CC SERENATA	389
A3479SP-1CC SERENATA	388
A3479SP-6CC SERENATA	388
A3503AL-1BK ATLAS	453
A3503AL-1WH ATLAS	453
A3503AL-2BK ATLAS	453
A3503AL-2WH ATLAS	453
A3579AP-1AB ALICE	196
A3579LM-5AB ALICE	197
A3579LT-3AB ALICE	197
A3579PN-3AB ALICE	197
A3579SP-3AB ALICE	196
A3588LT-1PB RAMADA	72
A3710AL-1BK PLATE	449
A3710PA-1BK PLATE	449
A3711AL-1BK PLATE	449
A3711PA-1BK PLATE	449
A3777AP-1AB WINDSOR	199
A3777LM-3-2AB WINDSOR	199
A3777LM-6-2AB WINDSOR	199
A3988AP-2AB BOLLA-PICCOLO	251
A3988SP-12AB BOLLA-PICCOLO	250
A3988SP-16AB BOLLA-PICCOLO	250
A3988SP-20AB BOLLA-PICCOLO	251
A3988SP-25AB BOLLA-PICCOLO	251

A3989AP-1AB BOLLA-PICCOLO	251
A3990AP-1CC FURORE	181
A3990LM-6CC FURORE	180
A3990LT-1CC FURORE	181
A3990PN-1CC FURORE	181
A3990SP-1CC FURORE	181
A4001LT-1CC MERGA	64
A4001LT-1GO MERGA	64
A4002LT-1CC TAIYI	66
A4002LT-1GO TAIYI	66
A4003LT-1CC KORFU	65
A4003LT-1GO KORFU	65
A4007LT-1GY BUNDA	58
A4007LT-1WH BUNDA	58
A4008LT-1BK SCHEDAR	83
A4008LT-1WH SCHEDAR	83
A4013LT-1GO GINAN	79
A4014LT-1GO IKLIL	78
A4015LT-1BK IZAR	77
A4015LT-1GO IZAR	77
A4015LT-1WH IZAR	77
A4016LT-1BK REVATI	67
A4016LT-1WH REVATI	67
A4017LT-1CC LOUIS	53
A4019LT-1CC AZALIA	52
A4022LT-1CC CLINT	53
A4023PN-1CC WASAT	115
A4024LT-1CC CAPELLA	52
A4025LT-1PB MUSICA	51
A4027AP-1PB MATAR	186
A4027LM-6PB MATAR	186
A4027LT-1PB MATAR	186
A4028LT-1PB PORRIMA	72
A4029LT-1CC MURANO	50
A4029LT-1GO MURANO	50
A4031AP-1PB PROXIMA	111
A4031LT-1PB PROXIMA	111
A4031PN-1PB PROXIMA	111
A4032LT-1GO FIRE	69
A4035LT-1GO FIRE	69
A4036LT-1GO MAIA	46
A4038AP-1CC IBIZA	183
A4038PL-5CC IBIZA	183
A4038PL-8CC IBIZA	183
A4039LT-1CC PROCYON	80
A4039LT-1GO PROCYON	80
A4041AP-2CC PIPIRIMA	376
A4041SP-5CC PIPIRIMA	376
A4041SP-8CC PIPIRIMA	376
A4047AP-1CC TALITHA	182
A4047PL-5CC TALITHA	182
A4047PL-8CC TALITHA	182
A4048PN-1CC WASAT	114
A4052AP-2SG EVIE	375
A4052LM-12SG EVIE	374
A4052LM-6SG EVIE	374
A4052SP-12SG EVIE	375
A4052SP-1SG EVIE	374
A4052SP-8SG EVIE	375
A4053PN-1BK CONNOR	121
A4054PN-1PB DYLAN	116
A4055PN-1BK COMBO	120

A4056PN-1WH COMBO.....	120
A4060PN-1CC PAOLO.....	117
A4060PN-1PB PAOLO.....	117
A4061LT-1CC SARIN.....	55
A4061LT-1PB SARIN.....	55
A4062LT-1CC JESSICA.....	47
A4062LT-1PB JESSICA.....	47
A4063LT-1CC POPPY.....	63
A4063LT-1GO POPPY.....	63
A4064LT-1BR RUBY.....	74
A4065AP-2SG PIPIRIMA.....	377
A4065SP-6SG PIPIRIMA.....	377
A4065SP-9SG PIPIRIMA.....	377
A4066AP-2PB SOPHIA.....	372
A4066LM-11PB SOPHIA.....	373
A4066LM-6PB SOPHIA.....	373
A4067AP-2CC ROSABELLA.....	370
A4067LM-11CC ROSABELLA.....	370
A4067LM-7CC ROSABELLA.....	370
A4068AP-3SG THEEMIN.....	369
A4068LM-12SG THEEMIN.....	369
A4068LM-7SG THEEMIN.....	369
A4069AP-2AB LAMBRUSCO.....	371
A4069LM-13AB LAMBRUSCO.....	371
A4069LM-7AB LAMBRUSCO.....	371
A4070AP-2GO LILLY.....	362
A4070LM-12GO LILLY.....	362
A4070LM-9GO LILLY.....	362
A4072AP-2GO MAYA.....	368
A4072LM-6GO MAYA.....	368
A4072LM-9GO MAYA.....	368
A4073AP-2PB EVELYN.....	360
A4073LM-12PB EVELYN.....	360
A4073LM-7PB EVELYN.....	360
A4074AP-2CC DENEbola.....	366
A4074LM-10CC DENEbola.....	367
A4074LM-14CC DENEbola.....	366
A4074SP-12CC DENEbola.....	367
A4075AP-1BK RICCARDO.....	191
A4075LM-5BK RICCARDO.....	191
A4075LM-8BK RICCARDO.....	191
A4076AP-1CC FANTASIA.....	179
A4076LM-5CC FANTASIA.....	179
A4076LM-8CC FANTASIA.....	179
A4077AP-2GO MALLIKA.....	364
A4077LM-10GO MALLIKA.....	365
A4077LM-6GO MALLIKA.....	365
A4077SP-10GO MALLIKA.....	364
A4077SP-7GO MALLIKA.....	364
A4078AP-2GO KAPRI.....	361
A4078LM-12GO KAPRI.....	361
A4078LM-6GO KAPRI.....	361
A4079AP-1CC GRATO.....	178
A4079LM-6CC GRATO.....	178
A4079LM-8CC GRATO.....	178
A4080AP-2GO FELICITA.....	363
A4080LM-12GO FELICITA.....	363
A4080LM-6GO FELICITA.....	363
A4103AP-1CC YUKA.....	270
A4103AP-1GO YUKA.....	271
A4103SP-5GO YUKA.....	271
A4103SP-6CC YUKA.....	270

A4103SP-6GO YUKA.....	271
A4103SP-6PB YUKA.....	272
A4103SP-8CC YUKA.....	270
A4103SP-8GO YUKA.....	271
A4103SP-8PB YUKA.....	272
A4107AP-1BK CERCARE.....	123
A4107AP-1WH CERCARE.....	123
A4152SP-8SG EVIE.....	374
A4207AP-2CC INCANTO.....	387
A4207PL-9CC INCANTO.....	387
A4207SP-4CC INCANTO.....	387
A4237LT-1GY TWILLY.....	61
A4245SP-1BK EURICA.....	215
A4248SP-1BK EURICA.....	215
A4249SP-1BK EURICA.....	215
A4272LT-1GY ISOLA.....	60
A4285SP-1AC SPLENDIDO.....	259
A4285SP-1AM SPLENDIDO.....	259
A4285SP-1SM SPLENDIDO.....	259
A4289AP-1WH PASSERO.....	397
A4289LM-3WH PASSERO.....	396
A4289LM-6WH PASSERO.....	396
A4289SP-1WH PASSERO.....	397
A4289SP-3WH PASSERO.....	397
A4311LT-1WH SHAULA.....	54
A4329PN-2AB DUETTO.....	119
A4329PN-2CC DUETTO.....	119
A4376LT-1BS CLARK.....	76
A4408AP-1CC CALLISTO.....	431
A4410AP-1SR SCHELENBERG.....	195
A4410LM-6-2SR SCHELENBERG.....	195
A4410PL-1SR SCHELENBERG.....	195
A4410PL-3SR SCHELENBERG.....	195
A4415AP-1CC CALLISTO.....	431
A4420LT-1GO GUSTAV.....	81
A4420LT-1WH GUSTAV.....	81
A4421AL-1BK HADAR.....	451
A4421AL-2BK HADAR.....	451
A4421PA-1BK HADAR.....	451
A4429LT-1BA FIORI.....	59
A4429LT-1WA FIORI.....	59
A4501LT-1PB CAMELOT.....	71
A4524AP-1AB SAILOR.....	405
A4524PL-3AB SAILOR.....	405
A4524SP-1AB SAILOR.....	405
A4569AL-1BK BELFAST.....	447
A4569AL-2BK BELFAST.....	447
A4569PA-1BK BELFAST.....	447
A4569PF-2BK BELFAST.....	447
A4569SO-1BK BELFAST.....	447
A4577AP-1CK GRAZIOSO.....	407
A4577AP-1WG GRAZIOSO.....	406
A4577PL-3CK GRAZIOSO.....	407
A4577PL-3WG GRAZIOSO.....	406
A4577PL-5CK GRAZIOSO.....	407
A4577PL-5WG GRAZIOSO.....	406
A4577PL-8CK GRAZIOSO.....	407
A4577SP-1CK GRAZIOSO.....	407
A4577SP-1WG GRAZIOSO.....	406
A4636LT-1GY TIAKI.....	59
A470002 OPTIMA-ACCESSORIES.....	269
A470006 OPTIMA-ACCESSORIES.....	269

A470029 OPTIMA-ACCESSORIES.....	269
A470033 OPTIMA-ACCESSORIES.....	269
A470045 OPTIMA-ACCESSORIES.....	269
A471201 OPTIMA-ACCESSORIES.....	269
A471206 OPTIMA-ACCESSORIES.....	269
A5005LT-1WH ZIBAL.....	57
A5009AP-2AB PICTURE LIGHTS.....	149
A5016LT-1WH WURREN.....	56
A5017LT-1PB BAYMONT.....	44
A5022LT-1GY TITAWIN.....	57
A5023AP-1AB PICTURE LIGHTS BASIC.....	148
A5024AP-1PB RUPERT.....	110
A5024LT-1PB RUPERT.....	110
A5024PN-1PB RUPERT.....	110
A5029AP-1SS ROBERT.....	106
A5029LT-1SS ROBERT.....	106
A5029PN-1SS ROBERT.....	106
A5031AP-1PB APEROL.....	104
A5031AP-1SS APEROL.....	104
A5031LT-1PB APEROL.....	104
A5031LT-1SS APEROL.....	104
A5031PN-1PB APEROL.....	104
A5031PN-1SS APEROL.....	104
A5033LT-1WH SCHEAT.....	58
A5034LT-1WH NUSAKAN.....	56
A5035LT-1CC ZAURAK.....	62
A5035LT-1GO ZAURAK.....	62
A5036LT-1BR JISHUI.....	75
A5037AP-1CC JULIETTA.....	105
A5037LT-2CC JULIETTA.....	105
A5037PN-2CC JULIETTA.....	105
A5038LT-3BK ELNATH.....	88
A5038LT-3PB ELNATH.....	88
A5038LT-3WH ELNATH.....	88
A5039AP-1AB MARRIOT.....	101
A5039AP-1CC MARRIOT.....	100
A5039PN-1AB MARRIOT.....	101
A5039PN-1CC MARRIOT.....	100
A5039TL-1AB MARRIOT.....	101
A5039TL-1CC MARRIOT.....	100
A5040LT-1AB BANKER.....	87
A5041LT-1AB BANKER.....	87
A5043LT-1BK NAOS.....	43
A5043LT-1WH NAOS.....	43
A5044LT-1PB NEKKAR.....	45
A5045LT-1PB PLEIONE.....	45
A5046LT-1BK RUKBAT.....	42
A5051LT-1PB SAIPH.....	41
A5052LT-1CC SHERATAN.....	40
A5053LT-1PB STEFANIA.....	46
A5054LT-1PB TIANYI.....	73
A5055LT-1PB VARUM.....	70
A5056LT-1AB BRAVA.....	89
A5056LT-1CC BRAVA.....	89
A5056LT-1GO BRAVA.....	89
A5059LT-1PB BAYMONT.....	44
A5070LT-1PB BAYMONT.....	44
A5122LT-1BK WILLIAM.....	93
A5122LT-1WH WILLIAM.....	93
A5123LT-1BK CAMBRIDGE.....	95
A5123LT-1WH CAMBRIDGE.....	95
A5124LT-1BK LONDON.....	94

A5124LT-1WH LONDON.....	94
A5126LT-1BK EDWARD.....	92
A5126LT-1WH EDWARD.....	92
A5210AP-2AB AQUA-BARA.....	437
A5210AP-2CC AQUA-BARA.....	437
A5210AP-3AB AQUA-BARA.....	437
A5210AP-3CC AQUA-BARA.....	437
A5210AP-4AB AQUA-BARA.....	437
A5210AP-4CC AQUA-BARA.....	437
A5213AP-1BR MARTIN.....	216
A5213AP-1WG MARTIN.....	217
A5213AP-2BR MARTIN.....	216
A5213AP-2WG MARTIN.....	217
A5213SP-1BR MARTIN.....	216
A5213SP-1WG MARTIN.....	216
A5215PL-4BR MARTIN.....	216
A5215PL-4WG MARTIN.....	217
A5217AL-1BK COPPIA.....	443
A5217FN-1BK COPPIA.....	443
A5217PA-1BK COPPIA.....	443
A5308AP-1CC PICTURE LIGHTS LED.....	144
A5308AP-1WH PICTURE LIGHTS LED.....	144
A5312AP-1CC PICTURE LIGHTS LED.....	144
A5312AP-1WH PICTURE LIGHTS LED.....	144
A5349AP-1WH ANGELINA.....	393
A5349LM-5WH ANGELINA.....	393
A5349LM-8WH ANGELINA.....	393
A5663AP-1AB AQUA-BOLLA.....	430
A5663AP-1CC AQUA-BOLLA.....	430
A5664AP-1AB TRATTORIA.....	404
A5664LM-5AB TRATTORIA.....	404
A5695SP-5WH PALMER.....	399
A5700AP-1WH PINOCCHIO.....	401
A5700LM-5WH PINOCCHIO.....	401
A5700LT-1WH PINOCCHIO.....	401
A5700PN-1WH PINOCCHIO.....	400
A5822PN-1PB PAOLO.....	117
A5822PN-1SS PAOLO.....	117
A5896AP-1CC NORTH.....	185
A5896AP-1PB NORTH.....	185
A5896LM-6CC NORTH.....	185
A5896LM-6PB NORTH.....	185
A5896LT-1CC NORTH.....	184
A5896LT-1PB NORTH.....	184
A5896PN-1CC NORTH.....	184
A5896PN-1PB NORTH.....	184
A6010SP-1BK SABIK.....	210
A6010SP-1CC SABIK.....	210
A6010SP-1SG SABIK.....	210
A6014IN-1SS PIAZZA.....	460
A6015IN-1SS PIAZZA.....	460
A6017IN-1SS PIAZZA.....	460
A6020LT-1WH SPHERE.....	84
A6025LT-1WH SPHERE.....	84
A6030LT-1WH SPHERE.....	84
A6047PL-1AB AQUA-TABLET.....	427
A6047PL-1BK AQUA-TABLET.....	425
A6047PL-1CC AQUA-TABLET.....	427
A6047PL-1SS AQUA-TABLET.....	425
A6047PL-1WH AQUA-TABLET.....	425
A6047PL-2AB AQUA-TABLET.....	427
A6047PL-2BK AQUA-TABLET.....	425

A6047PL-2CC AQUA-TABLET	427
A6047PL-2SS AQUA-TABLET	425
A6047PL-2WH AQUA-TABLET	425
A6047PL-3AB AQUA-TABLET	427
A6047PL-3BK AQUA-TABLET	425
A6047PL-3CC AQUA-TABLET	427
A6047PL-3SS AQUA-TABLET	425
A6047PL-3WH AQUA-TABLET	425
A6068LT-1AB SENIOR	90
A6068LT-1BK SENIOR	90
A6068LT-1SS SENIOR	90
A6068LT-1WH SENIOR	90
A6097AP-1PB PASSONI	203
A6097LM-12PB PASSONI	202
A6097LM-15PB PASSONI	203
A6097LM-6PB PASSONI	202
A6097LM-8PB PASSONI	202
A6141AP-1AB SOSPIRO	419
A6141AP-1WH SOSPIRO	419
A6141AP-2AB SOSPIRO	419
A6141AP-2WH SOSPIRO	419
A6170AP-1GO HAMAL	262
A6170PL-1GO HAMAL	262
A6170SP-1GO HAMAL	262
A6215PA-1BK WAZN	459
A6218AL-1BK WAZN	459
A6218FN-1BK WAZN	459
A6218PA-1BK WAZN	459
A6308AP-1AB NAPOLI	141
A6312AP-1AB NAPOLI	141
A6508AP-1AB LEONARDO	138
A6512AP-1AB LEONARDO	138
A6708AP-1AB BARI	140
A6710LT-1WH SPHERE	84
A6710SP-1WH SPHERE	84
A6712AP-1AB BARI	140
A6812PL-1WH AQUA-TABLET LED	429
A6818PL-1WH AQUA-TABLET LED	429
A6824PL-1WH AQUA-TABLET LED	429
A6835SP-12AM VASSOIO	336
A6835SP-12SM VASSOIO	336
A6836PL-1WH AQUA-TABLET LED	429
A6837SP-12AM RIGLA	339
A6837SP-12CL RIGLA	339
A6837SP-12SM RIGLA	339
A6838SP-12AM RIGLA	339
A6838SP-12CL RIGLA	339
A6838SP-12SM RIGLA	339
A6839SP-12AM RIGLA	338
A6839SP-12CL RIGLA	338
A6839SP-12SM RIGLA	338
A6840SP-12AM RIGLA	338
A6840SP-12CL RIGLA	338
A6840SP-12SM RIGLA	338
A6905AP-1AB SAFARI	200
A6905LM-3AB SAFARI	200
A6905LM-5AB SAFARI	201
A6905LT-1AB SAFARI	200
A6905SP-1AB SAFARI	201
A7004AP-1BK CELAENO	276
A7004PL-5BK CELAENO	276
A7004PL-8BK CELAENO	276



A7004SP-1BK CELAENO	276
A7004SP-6BK CELAENO	276
A7005AP-1SS SCORCIO	123
A7009AP-1AB LETTURA	125
A7009AP-1BC LETTURA	125
A7009AP-1BK LETTURA	125
A7009AP-1BR LETTURA	125
A7009AP-1SS LETTURA	125
A7009AP-1WG LETTURA	125
A7009AP-1WH LETTURA	125
A7013SP-6BK CASTULA	277
A7014AP-1BK DALIM	278
A7014SP-5BK DALIM	278
A7014SP-8BK DALIM	278
A7015AP-1BK PAIO	261
A7015SP-1BK PAIO	261
A7017SP-4BK NUVOLA	277
A7029AP-1BK JACOB	219
A7029PL-3BK JACOB	219
A7029PL-9BK JACOB	219
A7031AP-1AB HARRY	145
A7031AP-1CC HARRY	145
A7033AP-1BK DAVID	218
A7033PN-1BK DAVID	218
A7033SP-1BK DAVID	218
A7037SP-1BK CAPPELLO	213
A7038SP-1BK CAPPELLO	213
A7039SP-1BK CAPPELLO	213
A7041SP-1BK DAVID	218
A7045AP-1BK MANCHESTER	221
A7045PL-6BK MANCHESTER	221
A7045PL-8BK MANCHESTER	221
A7046SP-1BK CASTELLO	214
A7046SP-1PB CASTELLO	214
A7272SP-45GO CANDY	403
A7274PL-27GO CANDY	403
A7274PL-27WH CANDY	402
A7274SP-36GO CANDY	403
A7274SP-36WH CANDY	402
A7274SP-45GO CANDY	403
A7274SP-9GO CANDY	403
A7301AP-1PB GRACIE	188
A7301LM-6PB GRACIE	189
A7301LT-1PB GRACIE	188
A7301PL-5PB GRACIE	188
A7301PL-8PB GRACIE	188
A7301PN-1PB GRACIE	189
#H/Д	382
A7410AP-4PB RAMONA	383
A7410PL-24CC RAMONA	382
A7410PL-24PB RAMONA	383
A7410PL-40PB RAMONA	383
A7603AP-1BK TWIST	122
A7603AP-1WH TWIST	122
A7620AP-1AB MANCHESTER	220
A7620SP-1AB MANCHESTER	220
A7625SP-1AB MANCHESTER	220
A7630SP-1AB MANCHESTER	220
A7708AP-1BK PICTURE LIGHTS LED	144
A7710SP-1AB CAMERON	239
A7712AP-1BK PICTURE LIGHTS LED	144
A7715SP-1AB CAMERON	239

A7720SP-1AB CAMERON	239
A7741AP-1AB MATISSE	247
A7741SP-1AB MATISSE	248
A7742SP-1AB MATISSE	248
A7745LT-1AB MATISSE	246
A7745SP-1AB MATISSE	247
A7745SP-2AB MATISSE	247
A7745SP-3AB MATISSE	246
A7746SP-1AB MATISSE	247
A7759AP-1PB YUKA	272
A7759PL-6PB YUKA	273
A7759SP-1PB YUKA	273
A7760SP-8CC WAVE	253
A7761SP-1CC WAVE	253
A7762SP-1CC WAVE	253
A7763SP-1CC WAVE	253
A7764SP-1AB MATISSE	248
A7765AP-1AB MATISSE	246
A7765SP-1AB MATISSE	248
A7766SP-1AB CODY	266
A7766SP-1BC CODY	266
A7767SP-1AB CODY	266
A7767SP-1BC CODY	267
A7768SP-1AB CODY	266
A7768SP-1BC CODY	267
A7769SP-1AB CODY	266
A7769SP-1BC CODY	267
A7770AP-1PB DELACRUA	275
A7770PL-6PB DELACRUA	275
A7770SP-13PB DELACRUA	275
A7770SP-1PB DELACRUA	275
A7770SP-6PB DELACRUA	274
A7770SP-9PB DELACRUA	274
A7777AP-1GO MONTANA	305
A7777SP-10GO MONTANA	305
A7777SP-3GO MONTANA	305
A7777SP-5GO MONTANA	305
A7780AP-1AB ALBUS	223
A7780AP-2AB ALBUS	222
A7780SP-5AB ALBUS	223
A7780SP-7AB ALBUS	223
A7780SP-9AB ALBUS	222
A7790AP-1BK VINCENT	226
A7790AP-1GO VINCENT	224
A7790SP-10BK VINCENT	226
A7790SP-10GO VINCENT	225
A7790SP-15BK VINCENT	227
A7790SP-15GO VINCENT	225
A7790SP-24BK VINCENT	227
A7790SP-24GO VINCENT	225
A7790SP-50BK SATURN	306
A7790SP-8BK VINCENT	227
A7790SP-8GO VINCENT	224
A7908AP-1BK SOL	142
A7912AP-1BK SOL	142
A7961SP-1CC JUPITER CHROME	254
A7961SP-1GO JUPITER GOLD	255
A7961SP-1RB JUPITER COPPER	256
A7962SP-1CC JUPITER CHROME	254
A7962SP-1GO JUPITER GOLD	255
A7962SP-1RB JUPITER COPPER	256

A7963SP-1CC JUPITER CHROME	254
A7963SP-1GO JUPITER GOLD	255
A7963SP-1RB JUPITER COPPER	256
A7964SP-1CC JUPITER CHROME	254
A7964SP-1GO JUPITER GOLD	255
A7964SP-1RB JUPITER COPPER	256
A8025AP-1BK RONNIE	147
A8025AP-1CC RONNIE	147
A8025AP-1GO RONNIE	147
A8025AP-1PB RONNIE	147
A8025AP-1WH RONNIE	147
A8027AP-1BK RONNIE	147
A8027AP-1CC RONNIE	147
A8027AP-1GO RONNIE	147
A8027AP-1PB RONNIE	147
A8027AP-1WH RONNIE	147
A8029SP-1WH PASSERO	397
A8046AP-1PB CHIANTI	139
A8048AP-1PB CHIANTI	139
A8313PL-5CC MOLECULE	384
A8313PL-5GO MOLECULE	385
A8313SP-6CC MOLECULE	384
A8313SP-6GO MOLECULE	385
A8313SP-9CC MOLECULE	384
A8313SP-9GO MOLECULE	385
A8371AL-1BK PORTICA	444
A8371PA-1BK PORTICA	444
A8381AL-1SS PORTICA	444
A8381PA-1SS PORTICA	444
A8531LT-1CC SHELDON	49
A8532LT-1CC SHELDON	49
A8555AP-2AB JENNIFER	187
A8555SP-6AB JENNIFER	187
A9183SP-1BK PANDORA	214
A9246AP-2AB HALL	112
A9246AP-2SS HALL	112
A9249AP-2AB HALL	112
A9310AP-1WG ORLEAN	193
A9310LM-5WG ORLEAN	193
A9310LM-8WG ORLEAN	193
A9518AP-1BA BONITO	198
A9518LM-5BA BONITO	198
A9518LM-8BA BONITO	198
A9569PN-2AB DUETTO	119
A9569PN-2BK DUETTO	119
A9569PN-2SS DUETTO	119
A9915SP-1BK TUREIS	258
A9915SP-1CC TUREIS	258
A9915SP-1PB TUREIS	258
A9920SP-1BK TUREIS	258
A9920SP-1CC TUREIS	258
A9920SP-1PB TUREIS	258

ITEM DESIGNATIONS

Обозначения изделий

			
AP	applique	wall lamp	бра
AL	applique strada	outdoor wall lantern	светильник уличный настенный
FN	colonna strada piccolo	outdoor stand lantern	светильник уличный на столб
IN	incorporabile	recessed	встраиваемый
LM	lampadario	chandelier	люстра
LT	lampada da tavolo	table lamp	настольный светильник
PA	colonna strada grande	outdoor pole lantern	светильник-столб уличный
PF	plafoniera strada	outdoor flush lantern	светильник уличный потолочный
PL	plafoniera	flush	светильник потолочный
PN	pavimento	floor lamp	торшер
SO	sospeso strada	outdoor pendant lantern	светильник-подвес уличный
SP	sospeso	pendant	подвесной светильник

Компания оставляет за собой право на опечатки, ошибки и корректировку технической информации.

Производитель имеет право без предварительного уведомления вносить изменения в изделия, которые не ухудшают его технические характеристики, а являются результатом работ по усовершенствованию его конструкции или технологии производства. Внешний вид товаров может отличаться от представленных в каталоге фотоматериалов в связи с особенностями полиграфии и восприятия цвета человеческим глазом, а также может незначительно меняться от партии к партии.

COLORS

Цвета

						
	COLORI	COLOURS	COLORIS	FARBEN	KOLORY	ЦВЕТА
AB	bronzo antico	antique bronze	antique bronze	antik bronze	antyczny brąz	античная бронза
AC	rame antico	antique copper	civre antique	antikes kupfer	antyczna miedź	античная медь
AZ	azzurro	azure	azure	blau	niebieski	голубой
AM	ambra	amber	ambre	bernstein	bursztyn	янтарный
BA	nero antico	antique black	antique noir	antik schwarz	antyczny czarny	античный черный
BC	cromo nero	black chrome	chrome noir	schwarzes chrom	czarny chrom	черный хром
BG	rame vecchio	old brass	vieux cuivre	alte kupfer	stara miedź	старая медь
BJ	beige	beige	beige	beige	beżowy	бежевый
BK	nero	black	noir	schwarz	czarny	черный
BL	blu	blue	bleu	blau	niebieski	синий
BN	nero dorato	black gold	noire or	schwarz gold	czarny-złoto	черно-золотой
BR	marrone	brown	brun	braun	brązowy	коричневый
BS	argento nero	black silver	noire argent	schwarz silber	czarne srebro	черное серебро
BZ	bronzo	bronze	bronze	bronze	brąz	бронза
CC	cromo	chrome	chrome	chrom	chrom	хром
CG	cognac	cognac	cognac	cognac	koniak	коньяк
CK	cioccolato	chocolate	chocolat	schokolade	czekolada	шоколад
CL	transparent	clear	clair	transparent	przezroczysty	прозрачный
CR	crema	cream	crème	sahne	krem	кремовый
GA	oro antico	antique gold	antique or	antik gold	antyczne złoto	античное золото
GO	oro	gold	or	gold	złoto	золото
GR	verde	green	vert	grün	zielony	зеленый
GY	grigio	grey	grises	grau	szary	серый
MG	lilla	magenta	lilas	lila	liliowy	сиреневый
OR	arancione	orange	orange	orange	pomarańczowy	оранжевый
PB	rame levigato	polished brass	laiton poli	poliert kupfer	miedź polerowana	полированная медь
PK	rosa	pink	rose	rosa	różowy	розовый
PR	perla	pearl	perle	perle	perła	перламутровый
RB	bronzo rosso	red bronze	rouges bronze	rot bronze	czerwony brąz	красная бронза
RD	rosso	red	rouge	rot	czerwony	красный
RI	ferro vecchio	old iron	vieux fer	alt eisen	stare żelazo	старое железо
SA	argento antico	antique silver	antique argent	antik silber	antyczne srebro	античное серебро
SB	argento niellato	nielloed silver	argent niellè	silber schwarz	srebro czarne	серебро чернёное
SG	oro opaco	matt gold	mat or	mattiert gold	matowe złoto	матовое золото
SI	argento	silver	argent	silber	srebrny	серебро
SM	fumoso	smoky	enfumé	rauchig	dymny	дымчатый
SR	ottone opaco	satın brass	laiton mat	messing-matt	matowa mosiądz	матовая латунь
SS	argento opaco	satın silver	nickel mat	silber-matt	matowe srebro	матовое серебро
VL	viola	violet	violet	violett	fioletowy	фиолетовый
WA	bianco antico	antique white	antique blanc	antik weiß	antyczny biały	античный белый
WC	bianco crema	cream white	crème blanc	creme weiß	kremowy biały	кремовый белый
WG	oro bianco	white gold	blanche or	weiß gold	biało-złoty	бело-золотой
WH	bianco	white	blanc	weiß	biały	белый
WS	argento bianco	white silver	blanc-argenté	weiß-silber	biało-srebrany	бело-серебряный
YL	giallo	yellow	jaune	gelb	żółty	желтый

SYMBOLS DESCRIPTION

Описание символов

	hook fastening provided	крепление под крюк в комплекте		adjustable fitting	регулируемая арматура
	bracket fastening provided	крепление-скоба в комплекте		remote control	дистанционное управление
	extra bracket with hook	дополнительный крюк для крепления к потолку в комплекте		IP rated	дополнительная влагозащитенность
	2 way installation (ceiling or pendant)	два типа установки: потолочный и подвесной		many steps switch	многопозиционный переключатель
	separated switching	раздельное включение для рожков		app control	мобильное управление
	dimmer switch included	выключатель-диммер в комплекте		touch switch	сенсорное включение
	switch included for wall lamps only	выключатель в комплекте (только для бра)		bulb included	лампа в комплекте
	PIR sensor incl	ИК-детектор			

DIMENSIONS DESCRIPTION

Обозначение размеров

A 4075 LM - 2 AB

Arte Series Lamp type Holders Colour



